

Attachment M
2009 Reclamation Plan Amendment

The 2009 Reclamation Plan Amendment for the East Materials Storage Area was originally submitted to the County of Santa Clara (County) in April 2009. In response to comments received from the County on the original submittal, Lehigh updated the 2009 Reclamation Plan Amendment in June 2009. The 2009 Reclamation Plan Amendment included as Attachment M reflects these changes.

Reclamation Plan Amendment
for
Permanente Quarry
State Mine ID # 91-43-0004

Submitted to:



Santa Clara County

Prepared for:

Lehigh Southwest Cement Company

Prepared by:

EnviroMINE Inc.

3511 Camino Del Rio South, Suite 403
San Diego, CA 92108
(619) 284-8515, Fax (619) 284-0115

Revised June 2009

Table of Contents

Topic	Page
1.0 Introduction	1
2.0 Environmental Setting	4
2.1 Project Location	4
2.2 Legal Description	4
2.3 Land Use and Zoning	4
2.4 General Physiography	8
2.5 Climate	8
2.6 Geology	8
2.7 Surface and Groundwater	10
2.8 Soil Types	10
2.9 Biological Resources	11
3.0 Reclamation Plan	17
3.1 Owner/Operator/Agent	17
3.2 Operational Characteristics	17
3.3 Post-Mining Land Use	18
3.4 Reclamation Phasing	25
3.5 Reclamation Standards	25
3.5.1 Wildlife Habitat	25
3.5.2 Backfilling, Regrading, Slope Stability, Recontouring	27
3.5.3 Revegetation, Topsoil Salvage, Maintenance and Redistribution	27
3.5.3.1 Soil Development and Topsoil Salvage	28
3.5.3.2 Replanting and Reseeding	29
3.5.3.3 Test Plot Program	32
3.5.3.4 Maintenance	33
3.5.3.5 Monitoring	33
3.6 Drainage, Diversion Structures, Waterways and Erosion Control and Stream Protection, Including Surface and Groundwater	35
3.7 Building, Structure and Equipment Removal	38
3.8 Public Health and Safety	38
3.9 Effect of Reclamation on Future Recovery of Mineral Resources	39
3.10 Financial Assurances	39
3.11 Statement of Responsibility	39
3.12 Administrative Requirements	40

Figures

Figure	Title	Page
1.0-1	Regional Location Map	2
1.0-2	USGS Vicinity Map	3
2.1-1	Vicinity Map	5
2.3-1	General Plan	6
2.3-2	Zoning Map	7
2.4-1	Existing Topography Map	9
2.8-1	Soil Types	12
2.9-1	Biological Resources	13
3.2-1	EMSA Phase A	19
3.2-2	EMSA Phase B	20
3.2-3	EMSA Phase C	21
3.2-4	Phase A/B Cross Sections	22
3.2-5	Phase C Cross Sections	23
3.2-6	Post-Reclamation Plan	24
3.6-1	Erosion Control Measures (All Phases)	37

Attachments

Unbound Attachment	Reclamation Plan Plot Plan
Attachment A	Legal Description
Attachment B	Biological Resources Assessment
Attachment C	Delineation Report
Attachment D	Erosion Control Plan Report
Attachment E	Geotechnical Report
Attachment F	Drainage Report
Attachment G	Revegetation Test Plot Program As-Built Report
Attachment H	Revegetation Plan
Attachment I	Master Plant List
Attachment J	Soil Mapping
Attachment K	Sequential Visual Simulation
Attachment L	1985 Reclamation Plan

1.0 Introduction

This is an amendment to the existing reclamation plan for the Permanente Quarry (Quarry) for the purpose of responding to concerns over regulatory compliance. The Quarry is a limestone and aggregate mining operation located in the unincorporated foothills of Santa Clara County west of the city of Cupertino (Figures 1.0-1 and 1.0-2). Mining at the Quarry occurs subject to the Surface Mining and Reclamation Act (SMARA), which requires mining operations to have a lead agency-approved reclamation plan. Santa Clara County (County) is the lead agency for the Quarry. Hanson Permanente Cement, Inc. owns the Quarry and Lehigh Southwest Cement Company is the operator (collectively, Lehigh).

The County approved the current reclamation plan for the Quarry (Reclamation Plan) in March 1985. The Reclamation Plan encompasses 330 acres, representing some areas that in 1985 supported active mining and material stockpiling. The Reclamation Plan did not encompass all mining disturbance present in 1985, including certain rock processing facilities, access roads and material storage sites. The inclusion or omission of such features was generally consistent with how SMARA's requirements were interpreted at that time.

This amendment to the Reclamation Plan (hereinafter, Amendment) adopts reclamation requirements under SMARA, and the County's surface mining ordinance and reclamation standards, for an overburden storage area identified as the East Material Storage Area (EMSA). The EMSA currently is not encompassed by the 1985 Reclamation Plan, and in June 2008 the County informed Lehigh that it considered the EMSA to be out of compliance with SMARA. The purpose of the Amendment is to address the compliance status of the EMSA by extending the Reclamation Plan coverage. The Amendment adopts new reclamation requirements for the EMSA pursuant to SMARA's current standards.

The Amendment does not address compliance issues concerning other areas of the Quarry. Such areas are anticipated to be the subject of future amendments to the Reclamation Plan, subject to certain compliance orders. The Amendment meets compliance objectives specific to the EMSA, which is located near the northeastern boundary of the property, is visible from nearby communities, and has been the subject of concerns regarding its appearance. The County has directed Lehigh to process the Amendment for the EMSA on a more accelerated schedule than could be applied to other areas of the Quarry due to geotechnical considerations.

Figure 1.0-1 Regional Location Map

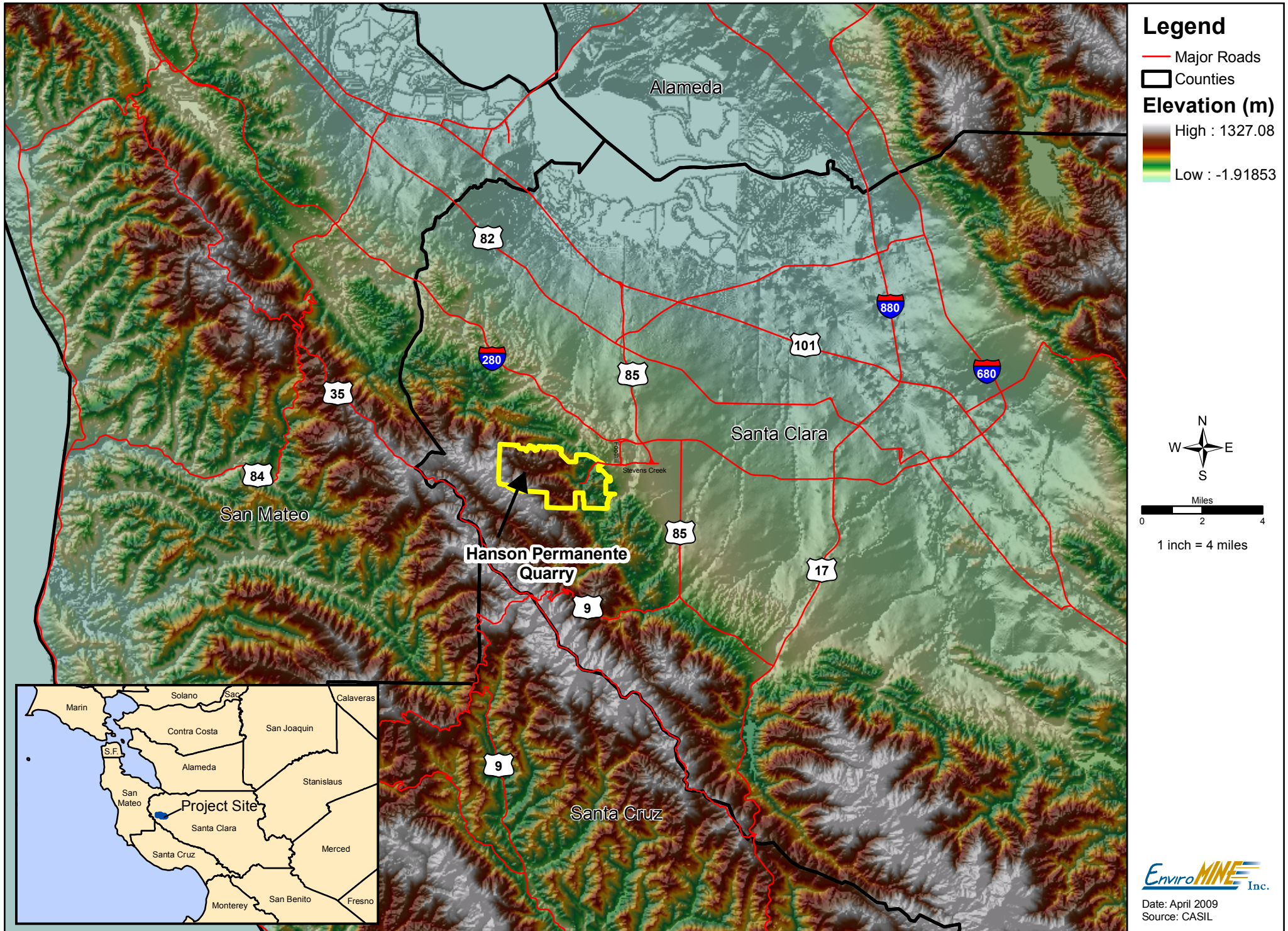
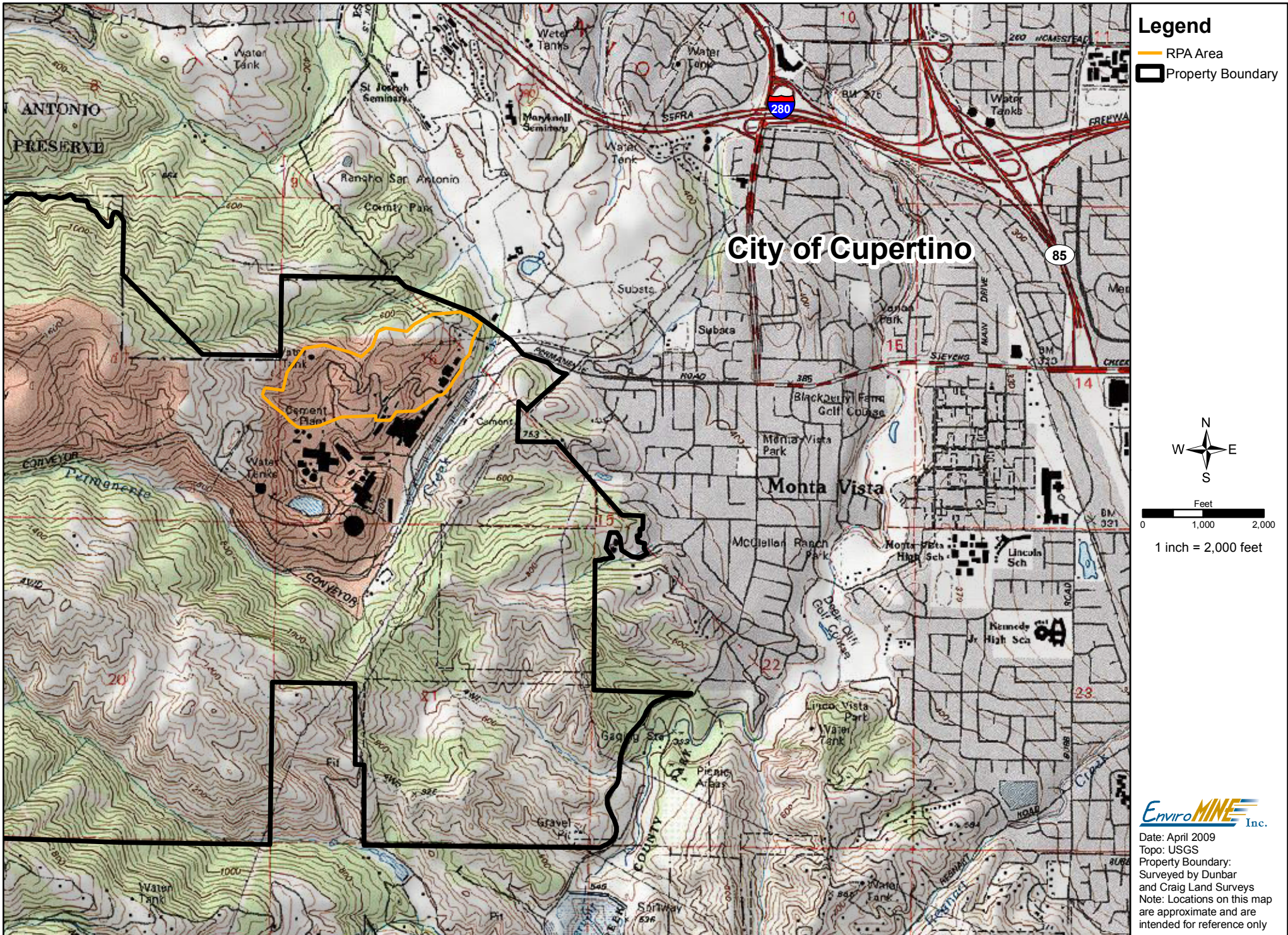


Figure 1.0-2 USGS Vicinity Map



Legend
— RPA Area
▭ Property Boundary

North Arrow
Scale: 1 inch = 2,000 feet
0 1,000 2,000 Feet

EnviroMINE Inc.
Date: April 2009
Topo: USGS
Property Boundary:
Surveyed by Dunbar
and Craig Land Surveys
Note: Locations on this map
are approximate and are
intended for reference only

2.0 Environmental Setting

2.1 Project Location

The area subject to this Amendment is referred to herein as the RPA Area. The RPA Area comprises approximately 89 acres and encompasses the EMSA. The RPA Area is a part of the Quarry, which is located in an unincorporated area of the western foothills of Santa Clara County near the city of Cupertino, approximately 3.0 miles from the intersection of Interstate 280 and Highway 85. (See Figure 2.1-1) Quarry access is provided by Stevens Creek Boulevard and Foothill Expressway, continuing to the western terminus of Permanente Road. The Quarry operates on a portion of approximately 3,600 contiguous acres owned by Lehigh.

2.2 Legal Description

The legal descriptions for parcels affected by the Amendment are provided in Attachment A.

2.3 Land Use and Zoning

Mining activity at the Quarry began by 1903. Quarrying has been continuous since at least 1939, and the Quarry is acknowledged as a legal, non-conforming use.

RPA Area

The RPA Area is located within unincorporated County land. A portion of the RPA Area is designated under the County General Plan as Hillsides (HS). The remainder has no County General Plan designation because it is within the City of Cupertino's Urban Service Area. (See Figure 2.3-1) The entire RPA Area is subject to the County zoning ordinance, and is classified as Agricultural (A-d1) and General Use (A1-d1 and A1-20s-d1) (See Figure 2.3-2). The Cupertino General Plan designation for land within the Urban Service Area is Very Low Density Residential, and recognizes the existing quarrying uses within the Urban Service Area.

Uses of Surrounding Lands

The uses immediately surrounding the RPA Area are owned and controlled by Lehigh and function as a buffer between mining operations and other land uses. (See Figures 1.0-1, 1.0-2, and 2.1-1.) To the west and south, these buffers are substantial. The nearest non-owned land-use to the south of the RPA Area is approximately 0.75 miles away and that is another mining operation. To the west, the nearest non-owned land is nearly 2.5 miles away and is utilized as open space. Existing uses of non-owned lands to the north include the Rancho San Antonio County Park and lands of the Mid Peninsula Regional Open Space District (MPROSD). Non-owned lands to the east include the Rancho San Antonio County Park, a cemetery and residential subdivisions. The nearest residence is located approximately 2,000 feet east of the RPA Area. Surrounding lands are generally subject to the General Plans and zoning ordinances of Santa Clara County and the City of Cupertino.

Figure 2.1-1 Vicinity Map

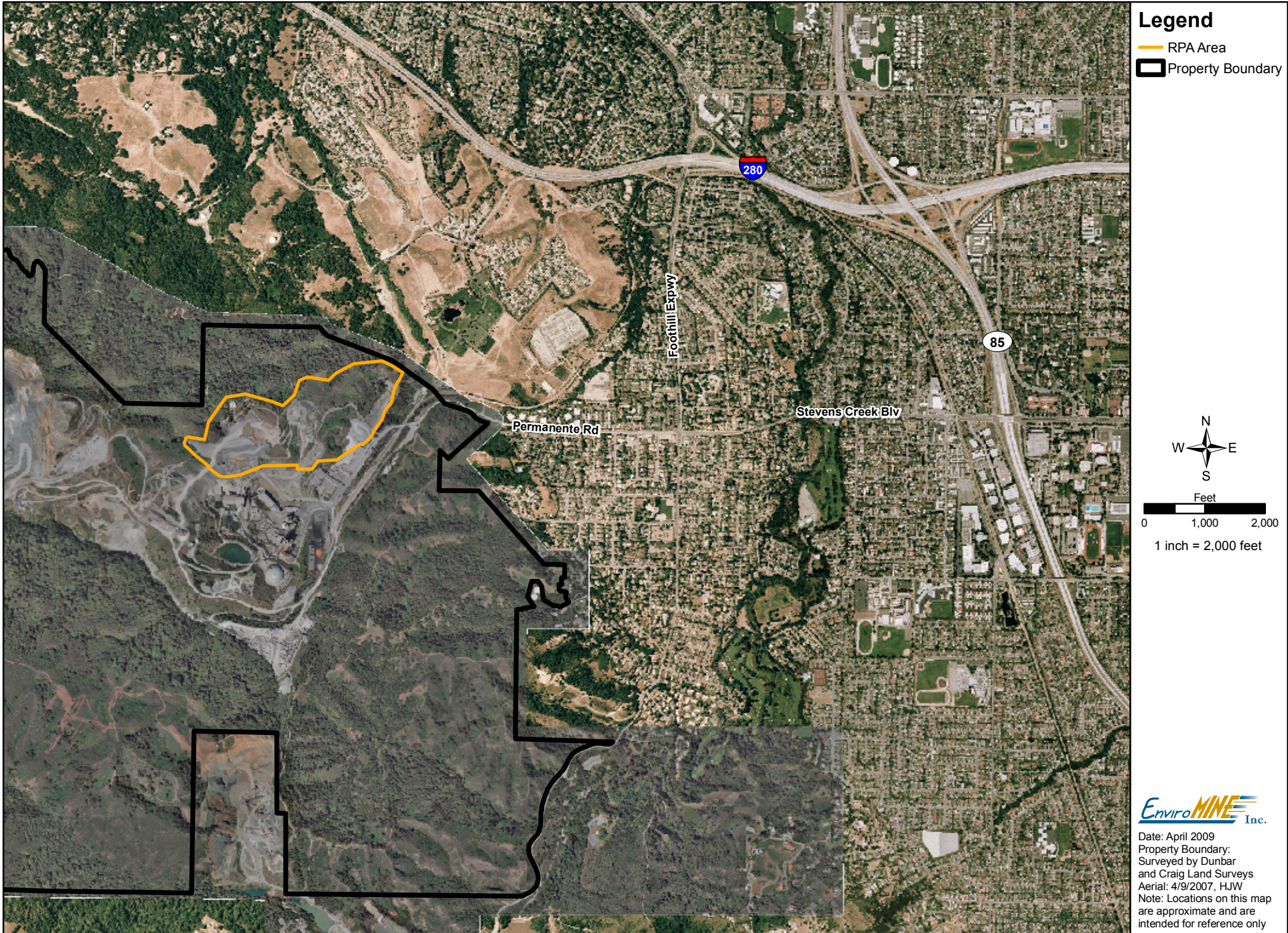


Figure 2.3-1 General Plan

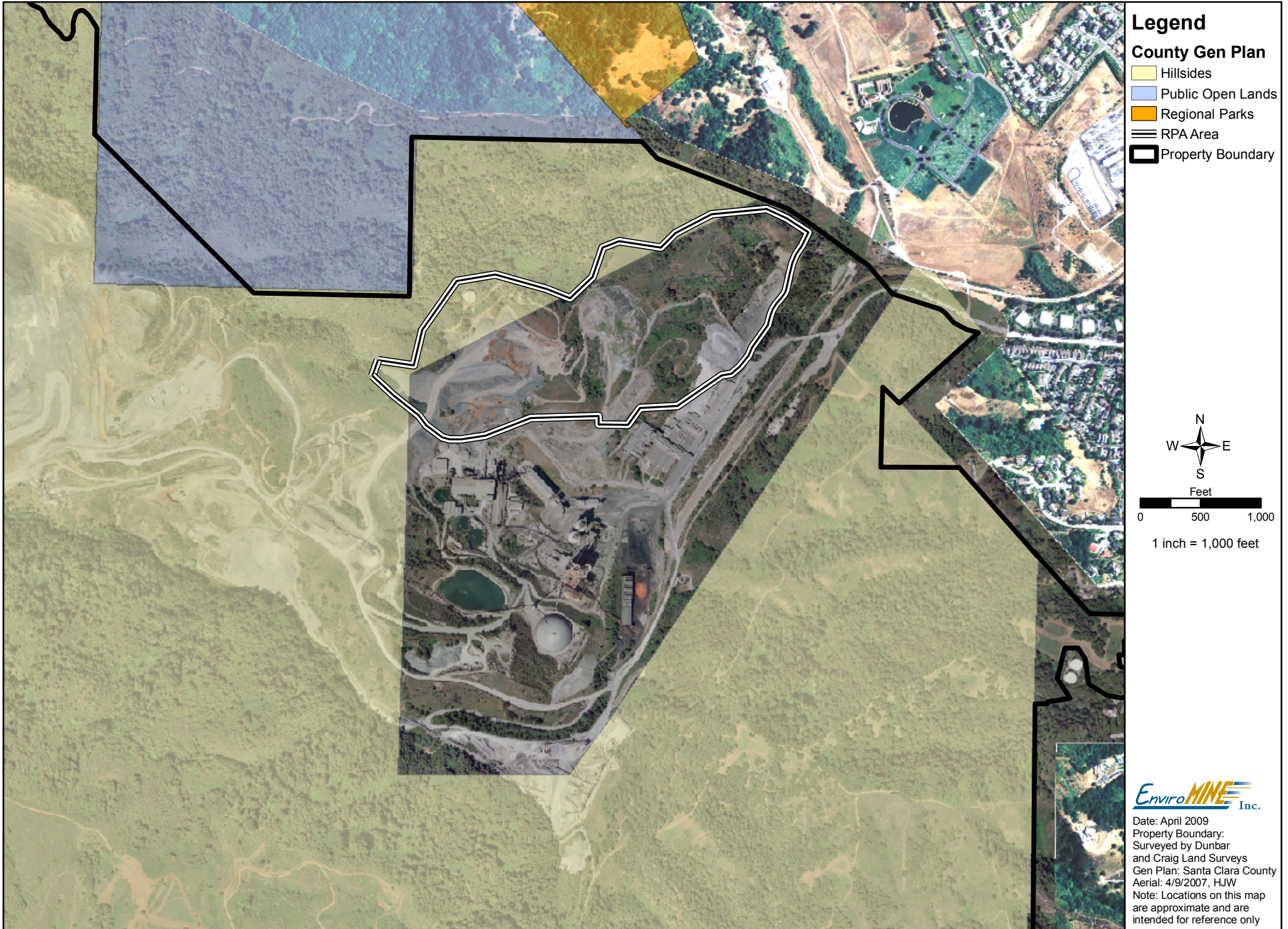
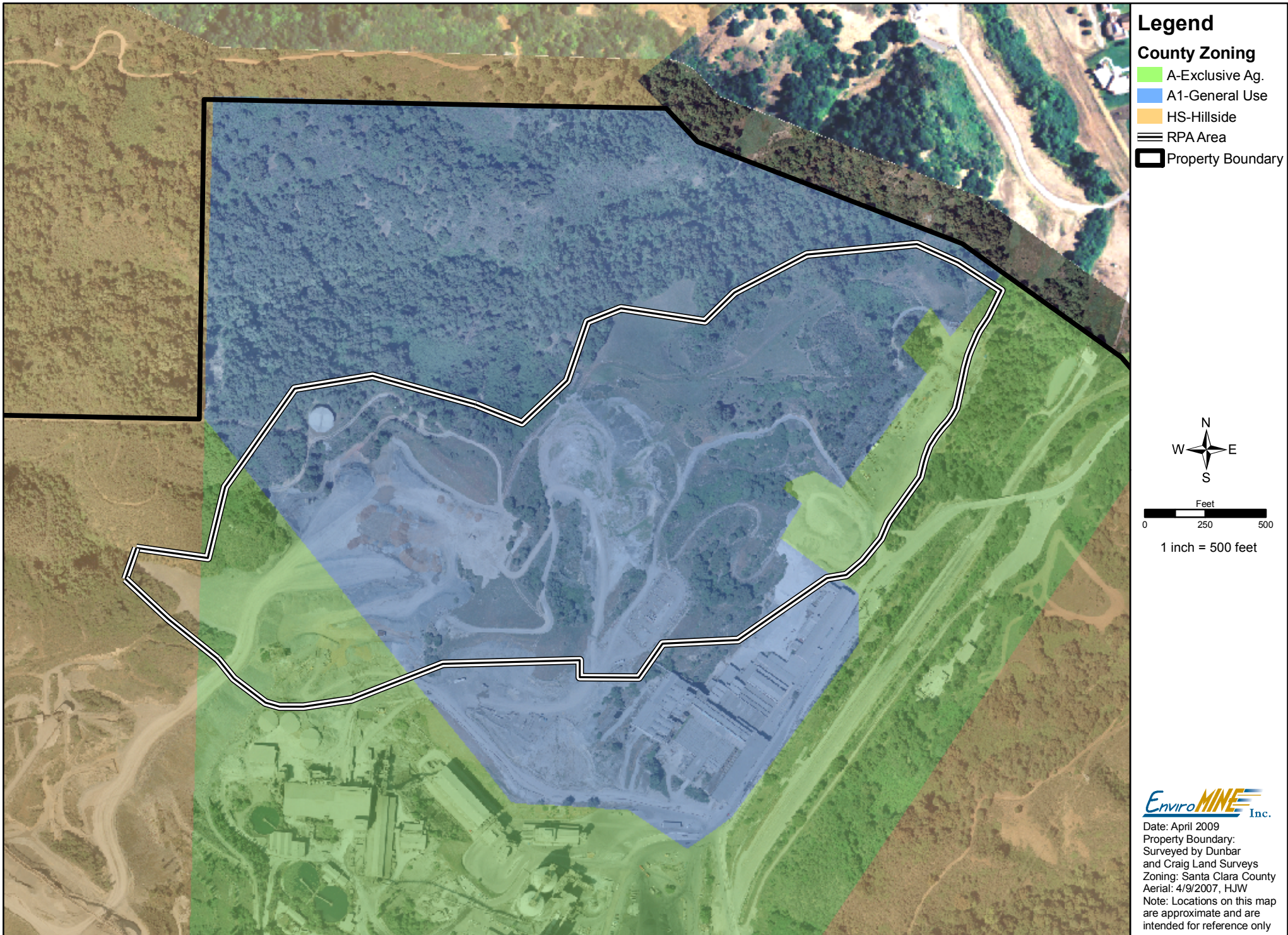


Figure 2.3-2 Zoning Map



2.4 General Physiography

Topography in the RPA Area and surrounding lands consists of gentle to steep terrain. These areas contain a series of ridges and valleys trending in a general east-west direction. Steep slopes predominate, with flatter terrain occurring within some previously disturbed areas. Elevations for operational areas within the larger Quarry area range from about 500 feet msl near the entrance to the Quarry to about 1,950 feet msl at the West Materials Storage Area (WMSA). Elevations within the RPA Area range from approximately 500 feet msl at the eastern edge to 950 feet msl at the western edge (See Figure 2.4-1). Reclamation activity is not proposed in the 100-year floodplain for any stream or within one mile upstream or downstream of any state highway bridge.

2.5 Climate

Typically, winds tend to blow from the mountains toward the valley in a general southwest to northeast direction. Winds are light averaging between 6 to 10 mph. During the summer, winds shift to blow from the north and northeast. Summer wind speeds range from 5 to 10 mph.

Temperatures range from the low 40's to about 60 degrees Fahrenheit from November through April. During the remainder of the year, temperatures range from the high 40's to the high 80's.

Annual rainfall in the area is typically between 20 and 25 inches. Precipitation patterns vary from year to year, but in general, the rainy season is from October through April. The warmer months (May to September) are essentially dry.

2.6 Geology

The geologic structure underlying the RPA Area and vicinity are detailed in the Geotechnical Report under Attachment E. In general, the regional geologic structure is dominated by the Coast Range structural province, consisting primarily of large-scale northwest/southeast-trending structures. The San Andreas fault zone, located approximately three miles west-southwest, is the major tectonic feature of the province displaying this trend. The Sargent-Berrocal fault zone is located to the east. This fault zone subdivides into two subsidiary fault zones, the southwestern-most Berrocal Fault Zone and the northwestern-most Monte Vista Fault Zone. The Berrocal Fault Zone trends northwest, dips steeply northeast and bisects the larger Quarry property. A northerly trending splay fault off of the Berrocal Fault Zone (whose existence is uncertain and inferred) trends to the south of the RPA Area. The Monte Vista Fault Zone is composed of two closely spaced subparallel fault strands trending northwest along the foothills-alluvial plain interface. The Monte Vista Fault Zone passes approximately 500 feet northeast of the property boundary. Also, see Table 1 from the 1985 RP: *Active and Potentially Active Faults and their Earthquake Characteristics*. The principal rock types in the vicinity belong to the Franciscan Assemblage, which underlies most of the property. The predominant Franciscan rock type is the Calera Member Limestone. This limestone unit grades from a dark to black, bituminous limestone member to a gray to white, high-chert-content limestone member.

Figure 2.4-1 Existing Topography Map



2.7 Surface and Groundwater

Surface Water

Natural hydrological sources for the RPA Area include direct precipitation and limited surface run-off from adjacent lands to the west and southwest. No USGS blue-line streams are present in the RPA Area nor do any discharge to the RPA Area. Overland flows from most of the RPA Area drain into Permanente Creek via culverts located in the far eastern portion of the RPA Area. Overland flows originating in the far northern portion of the RPA Area drain to the north, and enter Permanente Creek via an unnamed USGS blue-line stream to the north of the RPA Area. After leaving the property, Permanente Creek flows generally northwards where it receives flows from Hale Creek in Mountain View before reaching Mountain View Slough and South San Francisco Bay.

Groundwater

The RPA Area lies within the Santa Clara subbasin of the Santa Clara Valley groundwater basin. The Santa Clara subbasin totals approximately 240 square miles occupying a structural trough parallel to the northwest trending Coast Ranges. The Diablo Range bounds it on the east and the Santa Cruz Mountains form the basin boundary on the west. It extends from the northern border of Santa Clara County to the groundwater divide near the town of Morgan Hill approximately 25 miles southeast of the RPA Area. The dominant geohydrologic feature is a large inland valley east of the RPA Area. The valley is drained to the north by tributaries to San Francisco Bay including Coyote Creek, the Guadalupe River, and Los Gatos Creek. Within the RPA Area, groundwater is projected to lie a minimum of 30 to 100 feet below the existing ground surface based on geotechnical borings and historical data (see Geotechnical Report, Attachment E). There are no known springs in the RPA Area.

2.8 Soil Types

The Santa Clara Area Soil Survey (USDA 1952) indicates that the RPA Area is primarily situated upon four soil series, three native and one disturbed by past mining activities. Substantial portions of the RPA Area have been affected by prior operations. Although much of these native soil types are disturbed in the RPA Area, the descriptions below can be used to help guide the soil development goals. These soil types are discussed in the Revegetation Plan (Attachment H) and shown on Figure 2.8-1.

Soper gravelly loam, 35 to 50 percent slopes - The central portion of the RPA Area is mapped as this soil type; however, much of this area has been disturbed. The natural vegetation consists of brush and oak woodland. Where the soils have been cultivated, moderate erosion has resulted in most places. The subsoils in most places are dense enough to retard drainage to a moderate degree.

Los Gatos-Maymen complex, stony soils, 50+ percent slopes - The western half of the RPA Area is mapped as this soil type, of which approximately 25% is disturbed from past mining activities. The natural vegetation is almost entirely a dense growth of

brush and oak woodland, the chief value of which is watershed protection. The soils are underlain by hard but generally brown or shattered shale or sandstone that has undergone varying degrees of metamorphosis. Slopes are steep and stony and in most places rock outcrops are numerous.

Los Gatos clay loam, 20 to 35 percent slopes - This soil type occurs in the northeast part of the RPA Area. The soil supports a natural cover of grass, trees and grass, or brush. About 50% of the area mapped as this soil type in the RPA Area is disturbed.

Pit - This mapping unit consists of areas large enough to map where disturbance has occurred or original soil has been removed.

According to the soil survey of 1952, the native soils of the RPA Area were subject to erosion and gulying, were generally quite shallow, and hosted a plant community almost wholly dominated by grass and brush. Although quarry activities have disturbed these soils in the past, previous restoration plantings near the EMSA have shown that there is potential to restore plant communities and soil characteristics to a state similar to that described before disturbance.

2.9 Biological Resources (§3703)

Existing Plant Communities

The majority of the RPA Area has been disturbed as a result of operations beginning in 1939. The Biological Resources Assessment (Attachment B) contains a full description of the existing plant communities in the RPA Area. In summary, ten vegetation types were identified within the RPA area (see Figure 2.9-1), and no riparian plant communities, wetlands or creeks were observed. The vegetation types found in the RPA include:

Disturbed - Areas identified in the RPA Area as “Disturbed” have been recently disturbed by quarry activities and host a very small number of weedy and/or native plant species including yellow star thistle, coyote brush, chamise, wild oats, sweet fennel (*Foeniculum vulgare*), and field mustard. Generally, plant cover in these areas is very sparse due to the lack of topsoil.

Mixed Scrub - Mixed scrub includes shrub-dominated communities dominated by coyote brush (*Baccharis pilularis*), California sagebrush (*Artemisia californica*), and California buckwheat (*Eriogonum fasciculatum*) partially described as Diablan Sage Scrub. Mixed scrub was mapped throughout the RPA Area on southern exposures, and intergrades with chaparrals and oak woodlands. Additionally, small patches of this community type were mapped throughout the RPA Area where coyote brush or California buckwheat is the dominant shrub type. Mixed scrub in the RPA Area is characterized as dense to moderately open stands to 1.5 meters tall dominated by coyote brush, California sagebrush, and/or California buckwheat with little to no understory vegetation.

Figure 2.8-1 Soil Types

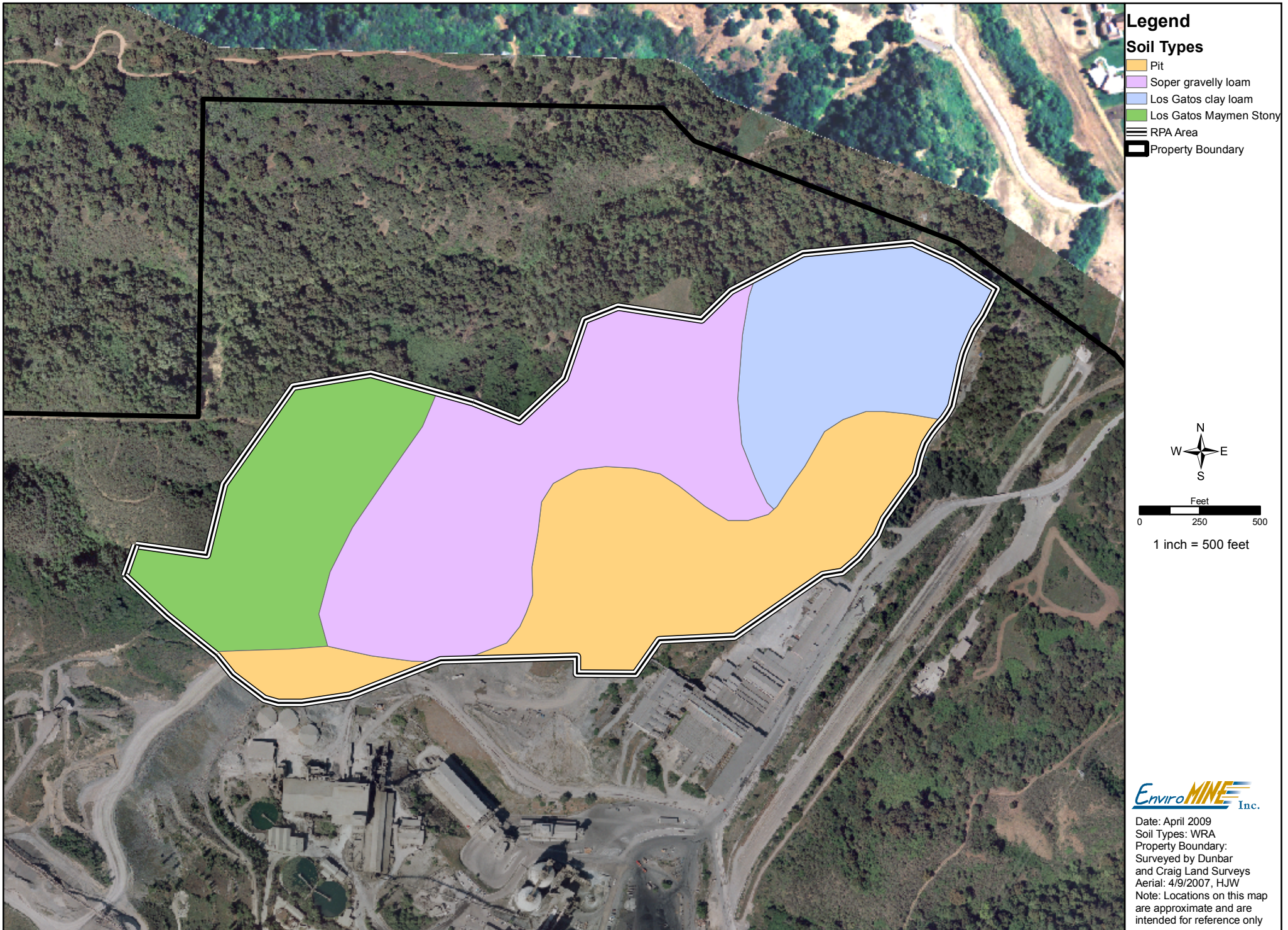
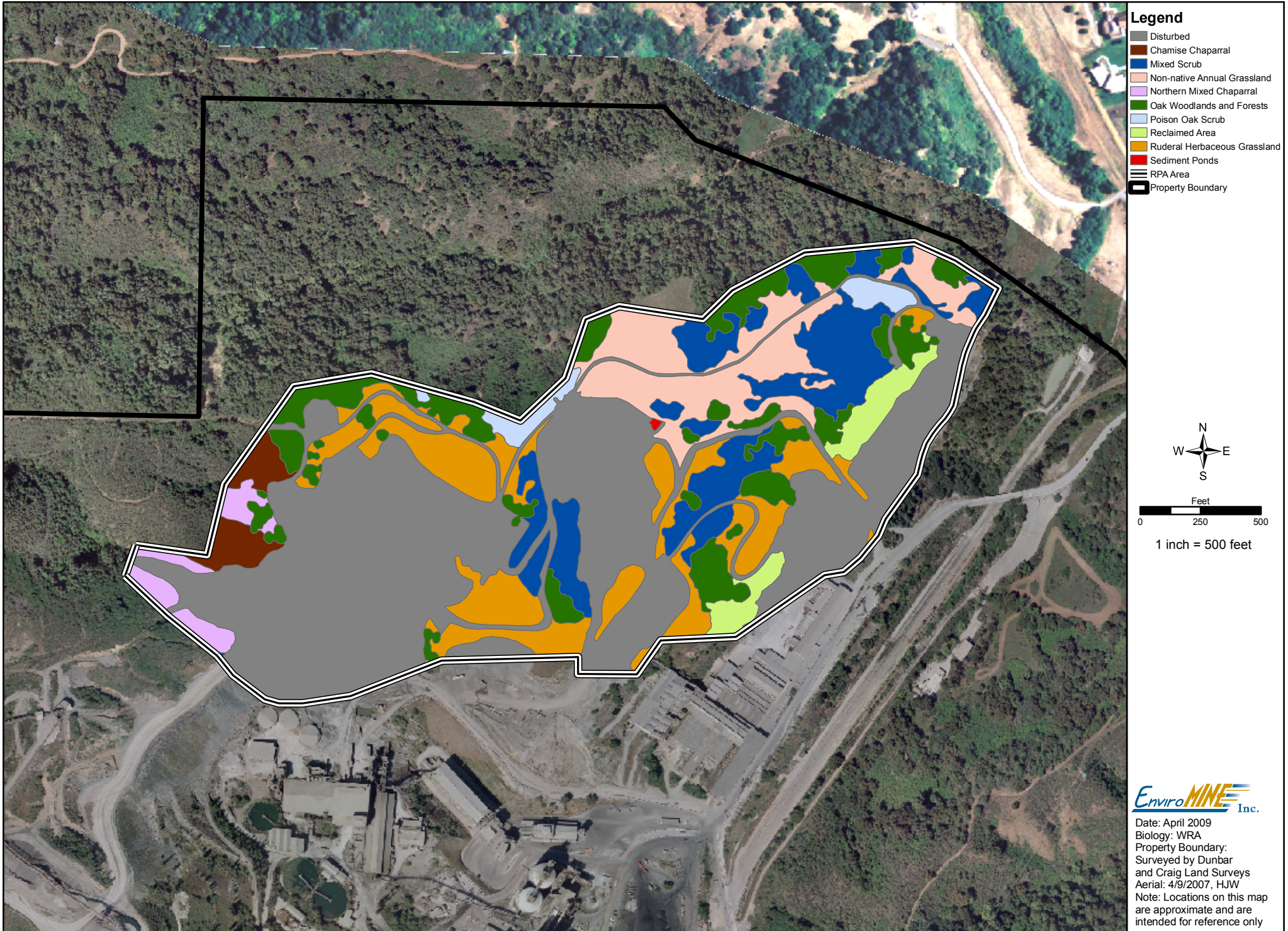


Figure 2.9-1 Biological Resources



Ruderal Herbaceous Grassland - Ruderal herbaceous grassland includes areas previously disturbed and/or reclaimed which have been inactive long enough to recruit a plant community dominated by herbaceous weeds and non-native grasses. Species typical of this plant community in California include brome grasses (*Bromus* sp.), wild oats (*Avena* sp.), Italian thistle (*Carduus pycnocephalus*), wild mustard (*Brassica* sp.), and filaree (*Erodium* sp.). Ruderal herbaceous grassland in the RPA Area primarily occurs on slopes between quarry roads, or in areas adjacent to quarry activities.

Non-native annual grassland - Non-native annual grassland is a dense to sparse cover of annual grasses 0.2 to 0.5 meters high. Characteristic species include wild oats, soft chess (*Bromus hordeaceus*), filaree (*Erodium botrys*, *E. cicutarium*, *E. moschatum*), Italian ryegrass (*Lolium multiflorum*), small fescue (*Vulpia microstachys*), and various native and non-native herbs and wildflowers. Non-native annual grassland was mapped in the RPA Area as intergrading with chaparrals and oak woodlands on slopes and ridgelines.

Oak Woodlands - Oak woodland is mapped primarily along north- and east-facing slopes and in small drainages. Within the RPA Area, oak woodland represents a combination of species, predominantly coast live oak (*Quercus agrifolia*) and blue oak (*Quercus douglasii*); however, a few small pockets dominated by interior live oak (*Quercus wislizeni*) are also present. These woodlands have dense overstories dominated by oak species without a substantial number of subdominant species, including poison oak, coffeeberry, ocean spray (*Holodiscus discolor*), elderberry (*Sambucus mexicana*), toyon, and gooseberries (*Ribes* sp.). Site reclamation will include plantings of not less than 975 oak trees. Oak tree plantings are described in section 3.5 below.

Revegetated Areas - Revegetated areas are historically disturbed slopes that have been recolonized by native and/or naturalized non-native vegetation. In some cases, these areas were graded to a final contour and planted at a low to moderate density with native shrubs and trees. In the RPA Area, the dominant species in these areas are coast live oak, coyote brush, purple sage (*Salvia leucophylla*), and a minor non-native grass component. Revegetated areas in the RPA Area are well established with vigorous shrub growth.

Chamise Chaparral - Chamise chaparral is a chaparral community dominated by 1 to 3 meter tall chamise with associated species contributing little to overall cover and mature stands containing very little herbaceous understory. Associated species typically include Manzanita species, scrub oak, buckbrush, birch-leaf mountain mahogany, yerba santa, sage (*Salvia* sp.), and California buckwheat. Chamise chaparral in the RPA Area was mapped on southern exposures with shallow soils. Chamise chaparral in the RPA Area ranges from 0.5 to 3 meters tall forming impenetrable stands with no herbaceous understory. It intergrades with northern mixed chaparral on eastern exposures and abruptly borders oak woodland and oak chaparral at ridgelines.

Poison oak scrub - Poison oak scrub is a shrub-dominated community maintained by frequent fires or other disturbance and completely dominated by poison oak. Poison oak scrub in the RPA Area contains extremely dense, monotypic stands of poison oak to 2 meters tall.

Northern Mixed Chaparral - Northern mixed chaparral is a community of broadleaved sclerophyll shrubs 2 to 4 meters tall forming dense often impenetrable stands dominated by chamise (*Adenostoma fasciculatum*), scrub oak (*Quercus berberidifolia*), various manzanitas (*Arctostaphylos* sp.), and various members of the genus *Ceanothus*. This community type occurs on dry, rocky, steep, typically south-facing slopes with thin soil. In the RPA Area, northern mixed chaparral was mapped in one small location on a south-facing slope. Northern mixed chaparral in the RPA Area forms dense impenetrable stands 2 to 3 meters tall with high species diversity in the shrub strata. It intergrades with oak woodlands and oak scrubs on deeper soils, and chamise chaparral on southern exposures.

Settling pond - One man-made settling pond for quarry runoff was identified in the RPA Area.

Wildlife

The Biological Resources Assessment (Attachment B) contains a full description of the animal species that currently are present or have a possibility of occurring within the RPA Area.

Two special status wildlife species have been observed within the RPA Area: the San Francisco Dusky-footed Woodrat (*Neotoma fuscipes annectens*) and the White-tailed Kite (*Elanus leucurus*). The Dusky-footed Woodrat occurs in brushy riparian habitats, coast live oak woodland, and dense scrub communities. Within the RPA Area, San Francisco Dusky-footed Woodrats have been observed and the location of woodrat houses has been mapped. The White-tailed Kite occurs in low elevation grassland, agricultural, wetland, oak woodland, savannah habitats, and riparian zones adjacent to open areas. Nest trees range from single isolated trees to trees within large contiguous forests. A pair of White-tailed Kites has been observed foraging and exhibiting pair bonding behavior along the northern portion of the RPA Area. No nest structures have been observed in the RPA Area.

Three special status wildlife species have a moderate to high potential to occur in the RPA Area: the Pallid bat (*Antrozous pallidus*), the Grasshopper Sparrow (*Ammodramus savannarum*), and the Loggerhead Shrike (*Lanius ludovicianus*). The nearest documented occurrence of the Pallid Bat is 5.0 miles to the north. This species prefers rock outcrops, mines, caves, hollow trees, buildings, and bridges. The stands of trees located along the northern RPA Area boundary provide a moderate potential for occurrence; other stands of trees within the RPA Area are highly fragmented and disturbed, and are unlikely to support bats. The Grasshopper Sparrow has been observed in sparsely vegetated areas within the active Quarry adjacent to the RPA Area. These are ground-nesting birds that prefer moderately open grasslands and prairies with patchy bare ground. The Loggerhead Shrike has not been documented within five miles of the RPA Area. This species is deemed to have a moderate potential to occur within the RPA Area based on the presence of suitable nesting habitat. This species prefers open habitats with scattered trees, shrubs, posts, fences, utility lines or other perches.

Another special-status species has been documented in the vicinity of the RPA Area but is considered unlikely to occur. California Red-Legged Frog (*Rana aurora draytonii*) has been documented along Permanente Creek adjacent to the RPA Area. Within the RPA Area, no suitable creeks or ponds exist that remain wetted for a sufficient period to provide aquatic breeding or non-breeding habitat for this species, and there are significant barriers to dispersal between occupied habitat and the RPA Area.

3.0 Reclamation Plan

3.1 Owner/Operator/Agent

Owner:

Hanson Permanente Cement, Inc.
24001 Stevens Creek Blvd.
Cupertino, CA 95014-5659

Operator:

Lehigh Southwest Cement Company
24001 Stevens Creek Blvd.
Cupertino, CA 95014-5659

Site Contact:

Henrik Wesseling, Plant Manager
24001 Stevens Creek Blvd.
Cupertino, CA 95014-5659

3.2 Operational Characteristics

The EMSA accepts overburden and low-calcium limestone generated by mining at the Quarry. The EMSA has been in operation since approximately 1939, and supports extractive operations that began at the Quarry in 1903 or earlier.

Material is transported to the EMSA from other parts of the Quarry by haul trucks, and deposited by end-dumping to the angle of repose in a series of lifts and phases. (See Figures 3.2-1 to 3.2-5.) Materials are subsequently keyed into existing slopes and rough-graded according to geotechnical recommendations. No mineral extraction or blasting activities occur in the RPA Area. Reclamation of the EMSA will include recontouring and revegetation as described in Section 3.5 below.

EMSA overburden placement is separated from the RPA Area boundary in most areas by a variable sized space. This space will be used for drainage and erosion control facilities, equipment access, and foundational preparation for the EMSA. This space will be left in an undisturbed condition where disturbance is unnecessary for storage, operational or reclamation activities.

Dust control in the EMSA during reclamation activities will be accomplished by the use of water trucks. Watering intervals for dust control will be dependent on weather conditions, but is generally anticipated multiple times per day. Water used for this purpose will be obtained from existing supply sources located on adjacent parcels.

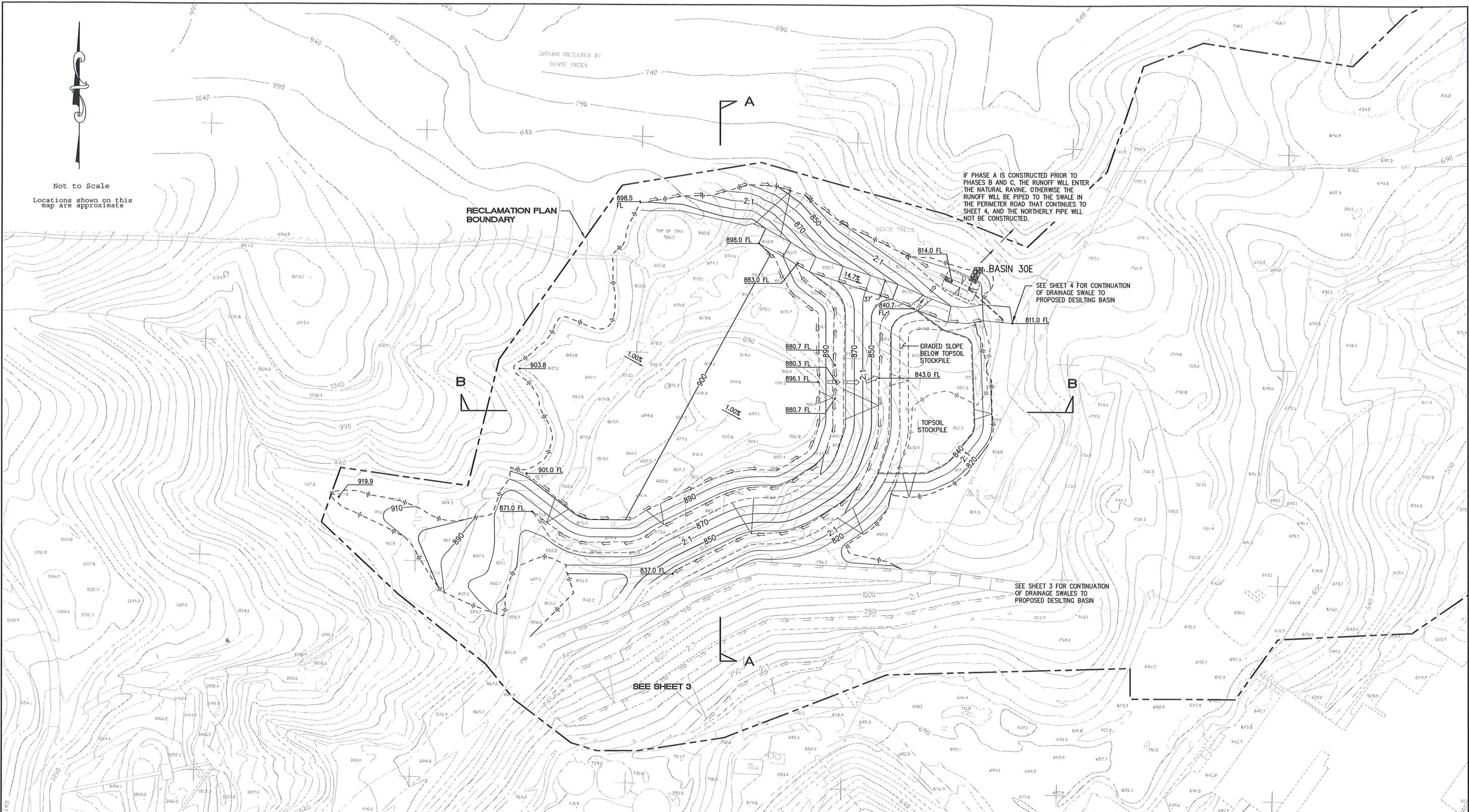
The EMSA is currently designed to accept total overburden placement of approximately 6.5 million tons (approximately 4.8 million cubic yards), and provide overburden storage for an estimated six years (see Section 3.4 below). Actual storage quantities and timelines are estimates, which depend on market demand, the rate of overburden production and other operational factors. The operational phases, contours and cross-sections for the EMSA are shown in Figures 3.2-1 through 3.2-5. The post-reclamation landform is shown on Figure 3.2-6.

Current conditions find an inactive powerline and a gas pipeline crossing the EMSA. Prior to placement of overburden on these areas, the powerline will be dismantled. The existing natural gas pipeline may remain in-place or be rerouted to serve existing facilities. All gas pipelines will be properly abandoned in-place once their functionality for serving existing facilities has ended.

3.3 Post-Mining Land Use

The post-reclamation land condition will be suitable for a variety of uses including open space. This use is consistent with the applicable land-use policies and zoning requirements for the RPA Area. Accordingly, the reclamation objectives are to 1) visually integrate the project with surrounding areas 2) control erosion, and 3) establish native vegetation. Reclamation will involve stabilizing slopes and planting native grasses, shrubs and trees. Successful reclamation of the RPA Area will establish oak woodland, chaparral and grassland communities similar to naturally occurring conditions in proximity to the RPA Area. The restoration of these natural community types will enhance the biological resource value of the EMSA over the existing conditions and provide habitat for native wildlife species.

Quarry operations outside of the RPA Area are expected to continue beyond the timeframe of storage activities described by the Amendment. The RPA Area may in the future be subject to additional storage or mining-related uses. The Amendment will not prevent the use of the RPA Area or portions thereof in the future for further mining operations, including additional overburden material storage. Future uses of the RPA Area for mining-related purposes would require further amendment of the Reclamation Plan.



Not to Scale
Locations shown on this map are approximate

IF PHASE A IS CONSTRUCTED PRIOR TO PHASES B AND C, THE RUNOFF WILL ENTER THE NATURAL RAVINE. OTHERWISE THE RUNOFF WILL BE PIPED TO THE SWALE IN THE PERIMETER ROAD THAT CONTINUES TO SHEET 4, AND THE NORTHERLY PIPE WILL NOT BE CONSTRUCTED.

SEE SHEET 4 FOR CONTINUATION OF DRAINAGE SWALE TO PROPOSED DESILTING BASIN

SEE SHEET 3 FOR CONTINUATION OF DRAINAGE SWALES TO PROPOSED DESILTING BASIN

SEE SHEET 3



OPERATOR		SHEET INDEX	
NAME:	LEHIGH SOUTHWEST CEMENT COMPANY	SHEET 1	COVER SHEET / NOTES / DETAILS
ADDRESS:	24001 STEVENS CREEK BLVD CUPERTINO, CA 95014	SHEET 2	PHASE A
TELEPHONE:	408-996-4227	SHEET 3	PHASE B
SHORT LEGAL:	SEC 18 T7S R2W MDBM; W 1/4 & SE 1/4 SEC 17 T7S R2W MDBM	SHEET 4	PHASE C
A.P.N.	351-09-022; 351-10-005, 037, 038	SHEET 5	EROSION CONTROL MEASURES (ALL PHASES)
SITE ADDRESS:	24001 STEVENS CREEK BLVD. CUPERTINO, CA 95014	SHEET 6	POST-RECLAMATION PLAN
		SHEET 7	PHASE A/B CROSS-SECTIONS
		SHEET 8	PHASE C CROSS-SECTIONS
		SHEET 9	OVERALL BOUNDARY/EASEMENTS

ChangConsultants
Civil Engineering-Hydrology-Hydraulics-Sedimentation
P.O. Box 9496 T: 858.692.0760
Rancho Santa Fe, CA 92087 F: 858.632.1402

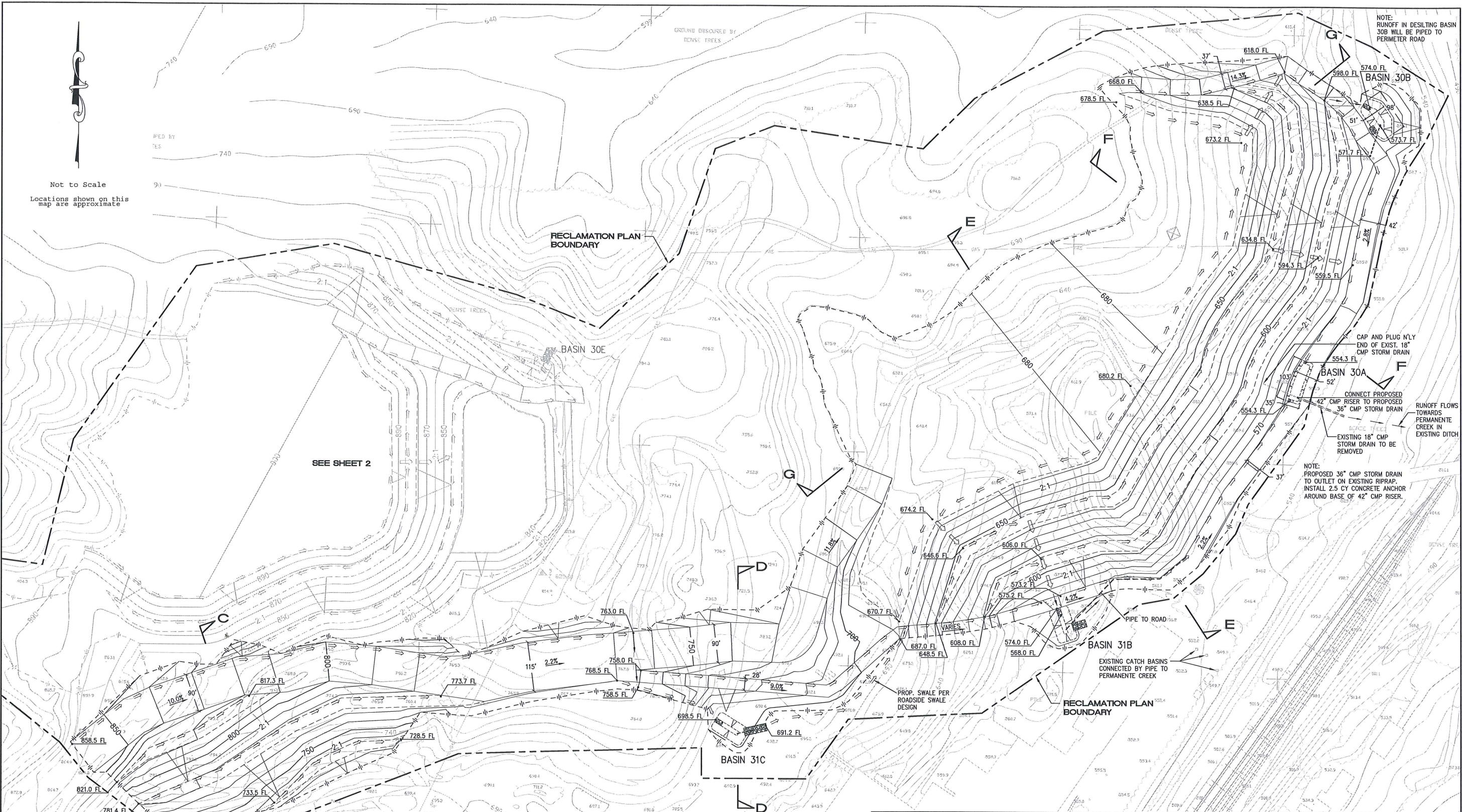
**PERMANENTE QUARRY
EAST MATERIALS STORAGE AREA
PHASE A**

REVISION 1	DATE	Figure 3.2-1	SHEET 2 OF 9
REVISION 2	DATE		
REVISION 3	DATE		

CO. FILE

FOR PLAN CHECK ONLY

CHANG CONSULTANTS
858.692.0760



Not to Scale
Locations shown on this map are approximate

SEE SHEET 2

NOTE: RUNOFF IN DESILTING BASIN 30B WILL BE PIPED TO PERIMETER ROAD

CAP AND PLUG N'LY END OF EXIST. 18" CMP STORM DRAIN
BASIN 30A
CONNECT PROPOSED 42" CMP RISER TO PROPOSED 36" CMP STORM DRAIN
EXISTING 18" CMP STORM DRAIN TO BE REMOVED
RUNOFF FLOWS TOWARDS PERMANENTE CREEK IN EXISTING DITCH
NOTE: PROPOSED 36" CMP STORM DRAIN TO OUTLET ON EXISTING RIPRAP. INSTALL 2.5 CY CONCRETE ANCHOR AROUND BASE OF 42" CMP RISER.

FOR PLAN CHECK ONLY



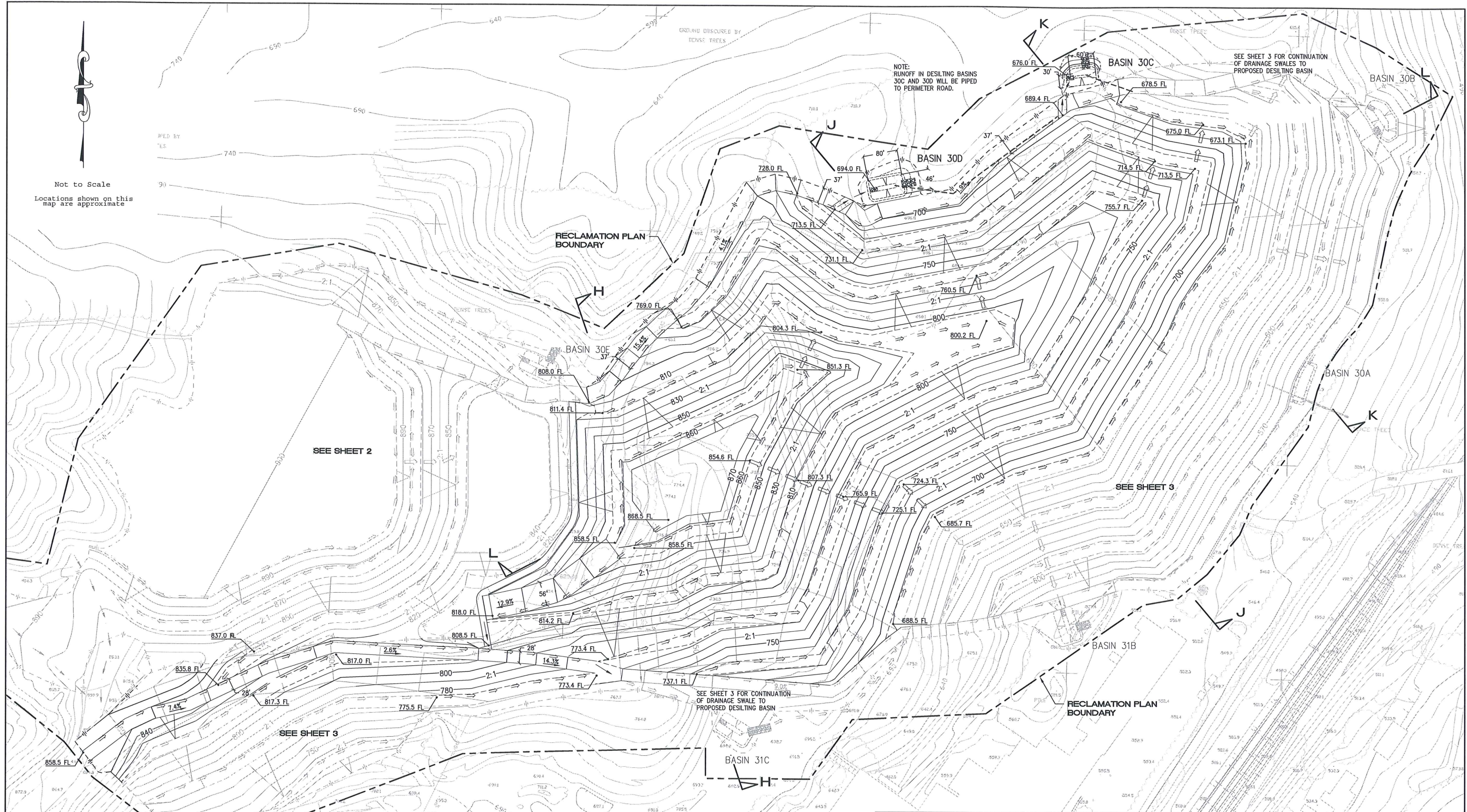
OPERATOR		SHEET INDEX	
NAME:	LEHIGH SOUTHWEST CEMENT COMPANY	SHEET 1	COVER SHEET / NOTES / DETAILS
ADDRESS:	24001 STEVENS CREEK BLVD CUPERTINO, CA 95014	SHEET 2	PHASE A
TELEPHONE:	408-996-4227	SHEET 3	PHASE B
SHORT LEGAL:	SEC 18 T7S R2W MDBM; W 1/4 & SE 1/4 SEC 17 T7S R2W MDBM	SHEET 4	PHASE C
A.P.N.:	351-09-022; 351-10-005, 037, 038	SHEET 5	EROSION CONTROL MEASURES (ALL PHASES)
SITE ADDRESS:	24001 STEVENS CREEK BLVD. CUPERTINO, CA 95014	SHEET 6	POST-RECLAMATION PLAN
		SHEET 7	PHASE A/B CROSS-SECTIONS
		SHEET 8	PHASE C CROSS-SECTIONS
		SHEET 9	OVERALL BOUNDARY/EASEMENTS

Chang Consultants
Civil Engineering-Hydrology-Hydraulics-Sedimentation
P.O. Box 9496 T: 858.692.0760
Rancho Santa Fe, CA 92087 F: 858.832.1402

**PERMANENTE QUARRY
EAST MATERIALS STORAGE AREA
PHASE B**

REVISION 1	DATE	Figure 3.2-2	SHEET 3
REVISION 2	DATE		OF 9
REVISION 3	DATE	CO. FILE	

CHANG CONSULTANTS
858.692.0760



Not to Scale
Locations shown on this map are approximate

OPERATOR		SHEET INDEX	
NAME:	LEIGH SOUTHWEST CEMENT COMPANY	SHEET 1	COVER SHEET / NOTES / DETAILS
ADDRESS:	24001 STEVENS CREEK BLVD CUPERTINO, CA 95014	SHEET 2	PHASE A
TELEPHONE:	408-996-4227	SHEET 3	PHASE B
SHORT LEGAL:	SEC 18 T7S R2W MDBM; W 1/4 & SE 1/4 SEC 17 T7S R2W MDBM	SHEET 4	PHASE C
A.P.N.:	351-09-022; 351-10-005, 037, 038	SHEET 5	EROSION CONTROL MEASURES (ALL PHASES)
SITE ADDRESS:	24001 STEVENS CREEK BLVD. CUPERTINO, CA 95014	SHEET 6	POST-RECLAMATION PLAN
		SHEET 7	PHASE A/B CROSS-SECTIONS
		SHEET 8	PHASE C CROSS-SECTIONS
		SHEET 9	OVERALL BOUNDARY/EASEMENTS



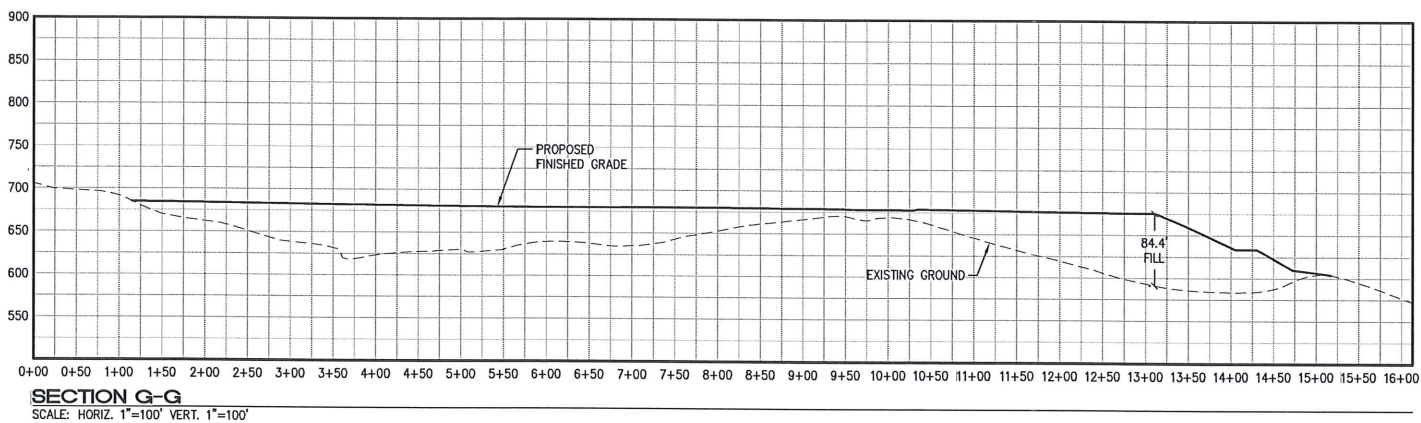
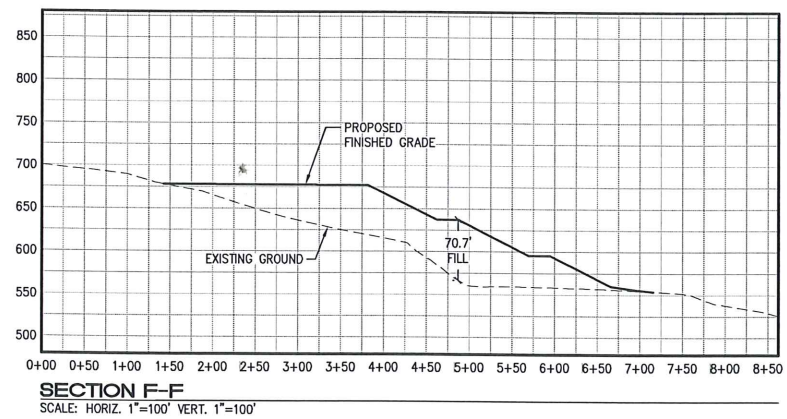
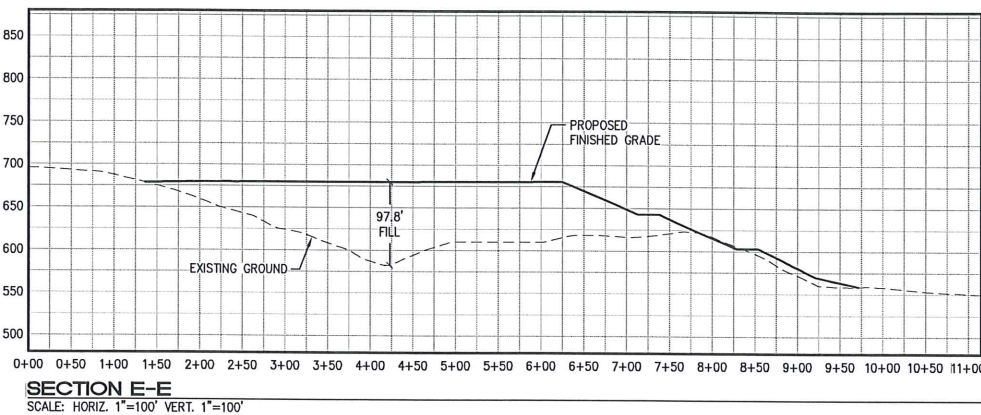
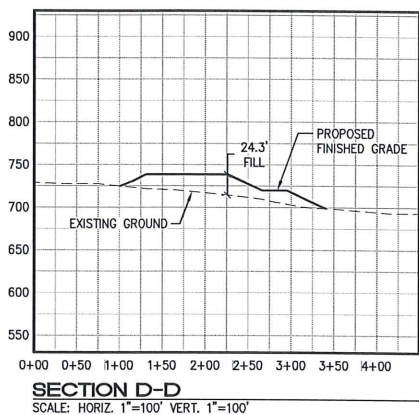
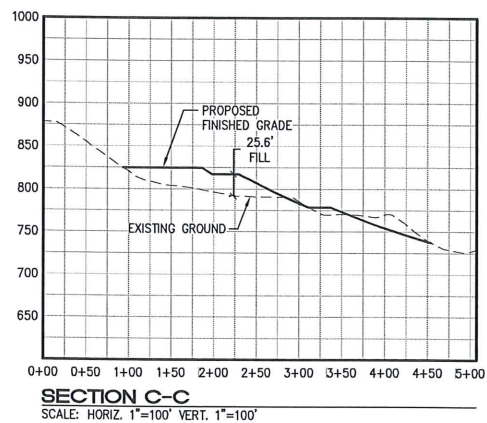
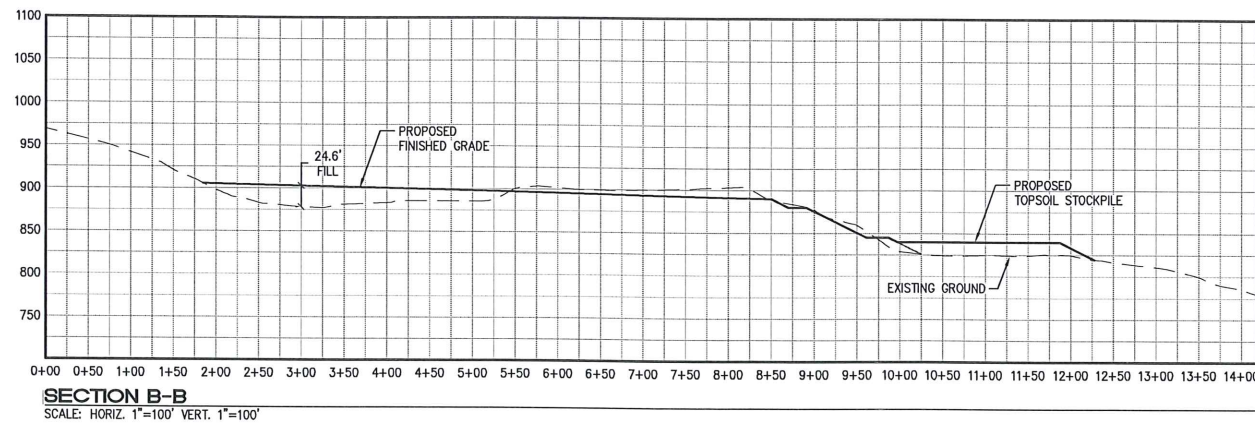
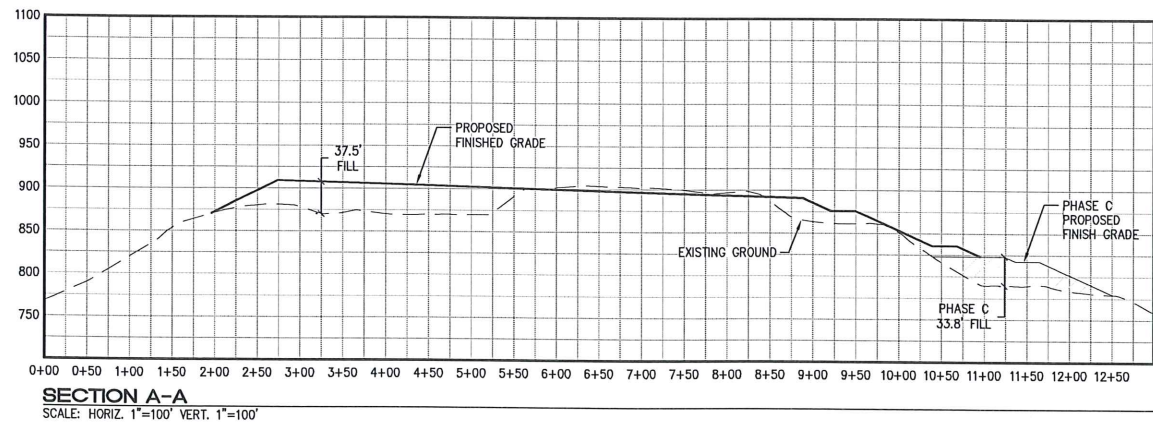
Chang Consultants
Civil Engineering-Hydrology-Hydraulics-Sedimentation
P.O. Box 9496 T: 858.692.0760
Rancho Santa Fe, CA 92087 F: 858.832.1402

**PERMANENTE QUARRY
EAST MATERIALS STORAGE AREA
PHASE C**

REVISION 1	DATE	Figure 3.2-3	SHEET 4 OF 9
REVISION 2	DATE		
REVISION 3	DATE	CO. FILE	

FOR PLAN CHECK ONLY

CHANG CONSULTANTS
858.692.0760



Not to Scale
Locations shown on this map are approximate



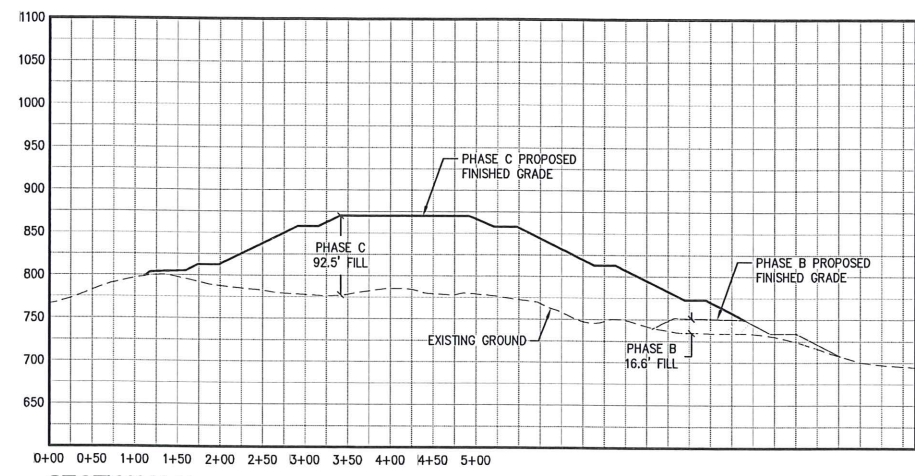
OPERATOR		SHEET INDEX		Chang Consultants Civil Engineering-Hydrology-Hydraulics-Sedimentation P.O. Box 9496 T: 858.692.0760 Rancho Santa Fe, CA 92087 F: 858.832.1402	
NAME:	LEHIGH SOUTHWEST CEMENT COMPANY	SHEET 1	COVER SHEET / NOTES / DETAILS	PERMANENTE QUARRY EAST MATERIALS STORAGE AREA PHASE A/B CROSS-SECTIONS	SHEET 7 OF 9
ADDRESS:	24001 STEVENS CREEK BLVD CUPERTINO, CA 95014	SHEET 2	PHASE A		
TELEPHONE:	408-996-4227	SHEET 3	PHASE B		
SHORT LEGAL:	SEC 18 T7S R2W MDBM; W 1/4 & SE 1/4 SEC 17 T7S R2W MDBM	SHEET 4	PHASE C	Figure 3.2-4	CO. FILE
A.P.N.:	351-09-022; 351-10-005, 037, 038	SHEET 5	EROSION CONTROL MEASURES (ALL PHASES)		
SITE ADDRESS:	24001 STEVENS CREEK BLVD. CUPERTINO, CA 95014	SHEET 6	POST-RECLAMATION PLAN	REVISION 1	DATE
		SHEET 7	PHASE A/B CROSS-SECTIONS	REVISION 2	DATE
		SHEET 8	PHASE C CROSS-SECTIONS	REVISION 3	DATE
		SHEET 9	OVERALL BOUNDARY/EASEMENTS		

FOR PLAN CHECK ONLY

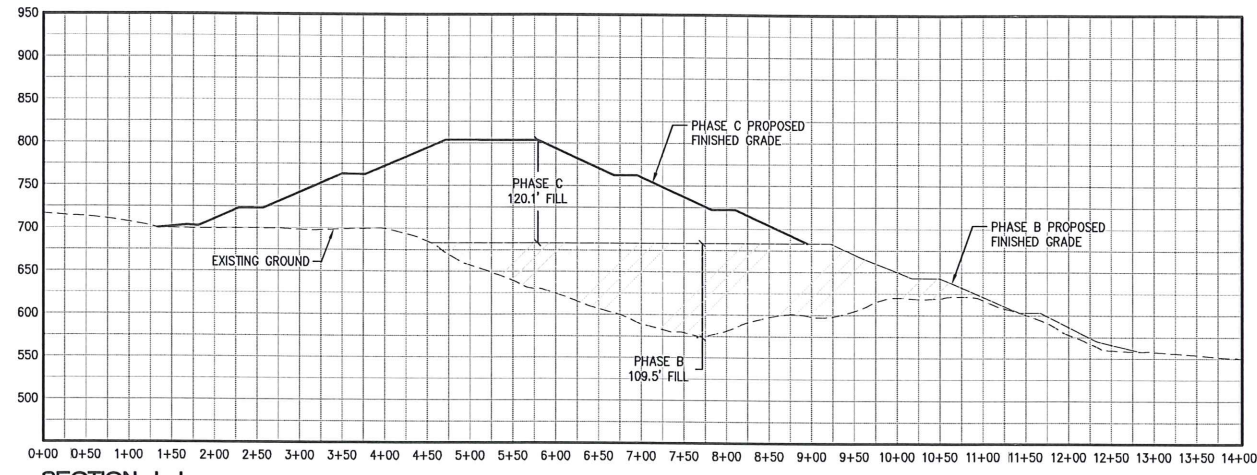
CHANG CONSULTANTS
858.692.0760

FOR PLAN CHECK ONLY

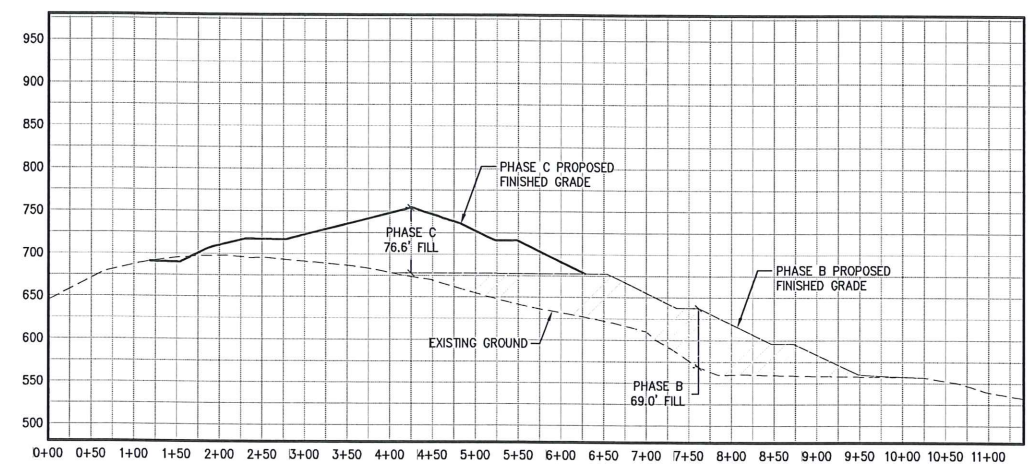
CHANG CONSULTANTS
858.692.0760



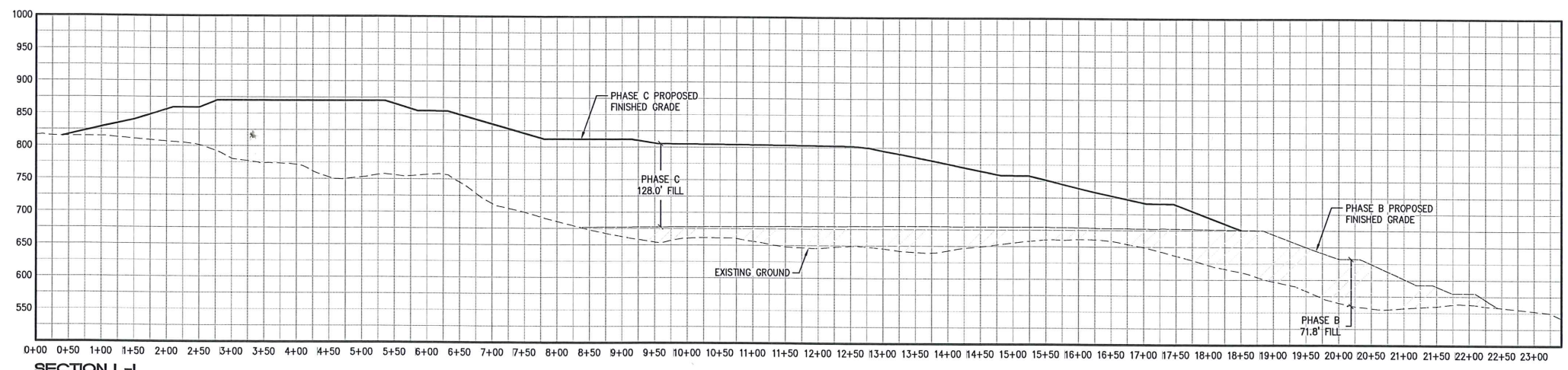
SECTION H-H
SCALE: HORIZ. 1"=100' VERT. 1"=100'



SECTION J-J
SCALE: HORIZ. 1"=100' VERT. 1"=100'

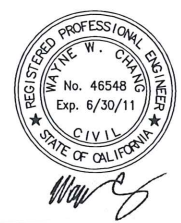


SECTION K-K
SCALE: HORIZ. 1"=100' VERT. 1"=100'



SECTION L-L
SCALE: HORIZ. 1"=100' VERT. 1"=100'

Not to Scale
Locations shown on this map are approximate



OPERATOR	
NAME:	LEHIGH SOUTHWEST CEMENT COMPANY
ADDRESS:	24001 STEVENS CREEK BLVD CUPERTINO, CA 95014
TELEPHONE:	408-996-4227
SHORT LEGAL:	SEC 18 T7S R2W MDBM; W 1/4 & SE 1/4 SEC 17 T7S R2W MDBM
A.P.N.:	351-09-022; 351-10-005, 037, 038
SITE ADDRESS:	24001 STEVENS CREEK BLVD. CUPERTINO, CA 95014

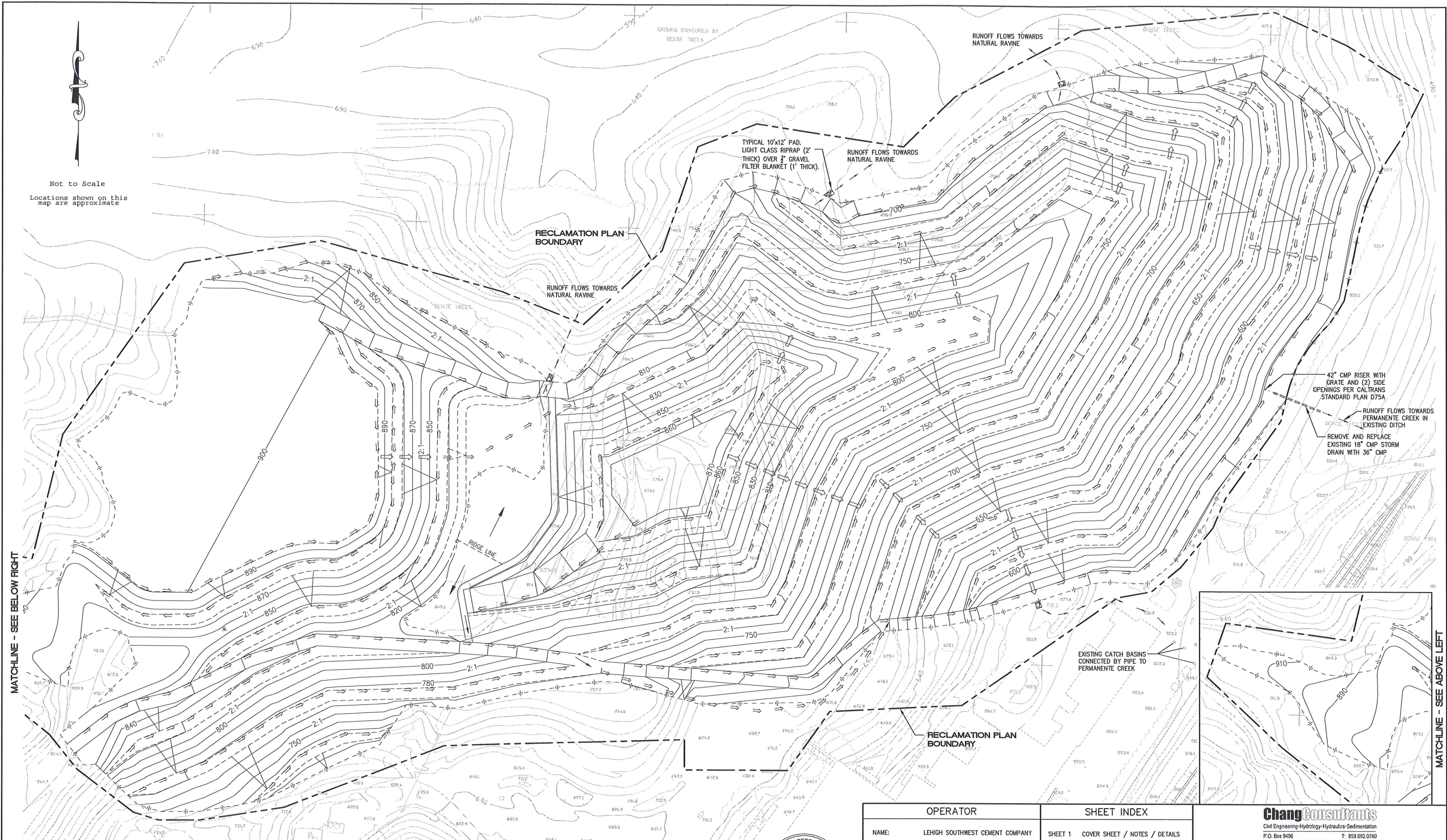
SHEET INDEX	
SHEET 1	COVER SHEET / NOTES / DETAILS
SHEET 2	PHASE A
SHEET 3	PHASE B
SHEET 4	PHASE C
SHEET 5	EROSION CONTROL MEASURES (ALL PHASES)
SHEET 6	POST-RECLAMATION PLAN
SHEET 7	PHASE A/B CROSS-SECTIONS
SHEET 8	PHASE C CROSS-SECTIONS
SHEET 9	OVERALL BOUNDARY/EASEMENTS

ChangConsultants
Civil Engineering-Hydrology-Hydraulics-Sedimentation
P.O. Box 9496 Rancho Santa Fe, CA 92087 T: 858.692.0760 F: 858.832.1402

**PERMANENTE QUARRY
EAST MATERIALS STORAGE AREA
PHASE C CROSS-SECTIONS**

REVISION 1	DATE	Figure 3.2-5	SHEET 8 OF 9
REVISION 2	DATE		
REVISION 3	DATE		

CO. FILE



Not to Scale
Locations shown on this map are approximate

MATCHLINE - SEE BELOW RIGHT

MATCHLINE - SEE ABOVE LEFT

FOR PLAN CHECK ONLY



OPERATOR		SHEET INDEX	
NAME:	LEHIGH SOUTHWEST CEMENT COMPANY	SHEET 1	COVER SHEET / NOTES / DETAILS
ADDRESS:	24001 STEVENS CREEK BLVD CUPERTINO, CA 95014	SHEET 2	PHASE A
TELEPHONE:	408-996-4227	SHEET 3	PHASE B
SHORT LEGAL:	SEC 18 T7S R2W MDBM; W 1/4 & SE 1/4 SEC 17 T7S R2W MDBM	SHEET 4	PHASE C
A.P.N.:	351-09-022; 351-10-005, 037, 038	SHEET 5	EROSION CONTROL MEASURES (ALL PHASES)
SITE ADDRESS:	24001 STEVENS CREEK BLVD. CUPERTINO, CA 95014	SHEET 6	POST-RECLAMATION PLAN
		SHEET 7	PHASE A/B CROSS-SECTIONS
		SHEET 8	PHASE C CROSS-SECTIONS
		SHEET 9	OVERALL BOUNDARY/EASEMENTS

ChangConsultants
Civil Engineering-Hydrology-Hydraulics-Sedimentation
P.O. Box 9496 Rancho Santa Fe, CA 92087
T: 858.692.0760 F: 858.832.1402

**PERMANENTE QUARRY
EAST MATERIALS STORAGE AREA
POST-RECLAMATION PLAN**

REVISION 1	DATE	Figure 3.2-6	SHEET 6 OF 9
REVISION 2	DATE		
REVISION 3	DATE		

CO. FILE

3.4 Reclamation Phasing

The Amendment utilizes concurrent, phased reclamation to ensure that reclamation occurs at the earliest possible time. Reclamation of the EMSA will be phased to allow revegetation as areas are sloped to final grade. Reclamation will generally occur in three phases, A, B and C, as detailed in Figures 3.2-1 through 3.2-5. Reclamation will proceed on a lift by lift basis. After each lift is graded to final contours, revegetation will occur as described in the Revegetation Plan. In general, reclamation consists of grading fill slopes to final contours, applying topsoil, installation of erosion control measures, reseeding and planting activities, and maintenance and monitoring.

The timing of reclamation depends upon the rate of overburden storage, which as noted is variable. The anticipated beginning and ending dates for each reclamation phase are as follows:

- A. Reclamation of Phase A is estimated to occur over an approximate six-year period beginning September 1, 2009 and concluding December 31, 2015.
- B. Reclamation of Phase B is estimated to occur over an approximate three-year period beginning September 1, 2009 and concluding December 31, 2012.
- C. Reclamation of Phase C is estimated to occur over an approximate five-year period beginning September 1, 2010 and concluding December 31, 2015.

Additional time periods may apply to each phase to allow for maintenance and monitoring of revegetation until the reclamation goals and standards described below are met.

3.5 Reclamation Standards

SMARA requires that reclamation plans incorporate verifiable standards to assure adequate completion of reclamation plan objectives. The verifiable reclamation standards have been adopted by the State Board of Mining and Geology as regulations to implement these requirements. (See Code of Regulations, Title 14, 3700 et seq.) The Amendment references these adopted reclamation standards and how they are addressed. Specific reclamation standards that are not relevant to the Amendment are not referenced.

3.5.1 Wildlife Habitat (§3703)

Reclamation is intended to establish wildlife habitat in the RPA Area in a condition that is superior to current conditions. Currently-disturbed areas that characterize portions of the RPA Area will be reclaimed with native vegetation and oak woodlands (see Section 3.5.3.2), thereby improving habitat. No wetlands currently exist in the RPA Area or will be affected by the activities described in this Amendment.

The Amendment incorporates protective measures to avoid impacts to special status avian species from reclamation activities. These measures are summarized below and described in greater detail in the Biological Resources Assessment (Attachment B):

1. Non-breeding season: If nesting birds are encountered during reclamation activities in the non-breeding season, defined as approximately September 1 to January 31, activities within a minimum of 50 feet of the nest will be postponed. Activities within this area will remain halted until the nest is abandoned or the young birds have fledged.
2. Breeding season: During the breeding season (approximately February 1 to August 31), pre-activity surveys will be conducted by a qualified biologist prior to ground disturbance activities. Surveys will be conducted for all suitable nesting habitat within 250 feet of potentially affected areas. All active non-status passerine nests identified will be protected by a 50-foot radius minimum exclusion zone. Active raptor or special status species' nests will be protected by an exclusion buffer with a minimum radius of 200 feet. A minimum 500 foot buffer will be established around active White-tailed Kite nests. Exclusion zones will remain in place until the nest is abandoned or the young have fledged. Should ground disturbance commence later than 14 days from the survey date, surveys will be repeated.

The Amendment also incorporates protective measures to avoid impacts to roosting bats. These measures are described in greater detail in the Biological Resources Assessment (Attachment B):

1. Non-roosting season (approximately September 1 to October 31): Where evidence of roosting is observed along the northern RPA Area boundary, activities will be halted within an appropriately-sized exclusion buffer to be determined by a qualified bat biologist.
2. Hibernation season (approximately November 1 to March 31): No activities will take place within 100 feet of the northern RPA Area boundary, unless a qualified bat biologist has determined that a given area does not provide suitable hibernating conditions and that bats are unlikely to be present in the area.
3. Maternity roosting season (approximately April 1 to August 31): Pre-activity surveys (night-time evening emergence surveys and/or internal searches) will be conducted within large tree cavities to determine the presence of bat maternity roosts along the northern portion of the project boundary. All active roosts identified during surveys will be protected by an appropriately-sized buffer to be determined by a qualified bat biologist. The buffer will be determined by the type of bat observed, topography, slope, aspect, surrounding vegetation, sensitivity of roost, type of potential disturbance, etc. Each exclusion zone would remain in place until the end of the maternity roosting season. If no active roosts are identified then the project may commence as planned. Survey results are valid for 30 days from the survey

date. Should work commence later than 30 days from the survey date, surveys should be repeated.

The Amendment also incorporates protective measures to avoid impacts to the San Francisco Dusky-footed Woodrat. These measures are described in greater detail in the Biological Resources Assessment (Attachment B):

1. Active woodrat houses should be flagged and avoided when possible. If avoidance is not feasible, the houses shall be dismantled by hand under the supervision of a biologist. If young are encountered during the dismantling process, the material will be placed back on the house and the house will remain unmolested for two to three weeks in order to give the young enough time to mature and leave the house on their own accord. After two to three weeks, the nest dismantling process may begin again. Nest material will be moved to suitable adjacent areas (oak woodland, scrub, or chaparral) that will not be disturbed.

3.5.2 Backfilling, Regrading, Slope Stability and Recontouring (§3704)

SMARA's reclamation standards provide that fill slopes, including overburden storage areas, shall not exceed 2H:1V except when based on a site-specific engineering and geologic analysis. Fill slopes in the RPA Area will be reclaimed at a maximum overall slope inclination between 2.5H:1V to 2.6H:1V. These slopes will be comprised of 2H:1V inter-bench slopes, interrupted by 25-foot wide benches spaced at 40-foot vertical intervals. These slopes have been determined to be stable under static and seismic loading conditions and are suitable for the proposed end use. Please refer to the attached Geotechnical Report (Attachment E).

Reclaimed fill slopes will conform to the surrounding hillside topography. The topography in the RPA Area and surrounding area is a variable but consistent rise in elevation in the east to west direction. Current elevations within the RPA Area range from approximately 500 to over 950 feet in elevation, and rise rapidly to the west of the RPA Area to an elevation of over 1500 feet. Reclaimed slopes will be generally consistent with the natural contours. Figure 3.2-6 show the reclaimed elevations.

Reclaimed slopes will occur over an appropriate foundation pursuant to the recommendations within the Geotechnical Report. Any refuse in the RPA Area will be collected in approved trash bins and hauled to the nearest approved landfill for disposal. Equipment and materials will be dismantled, if necessary, and moved to an alternate onsite or offsite location.

3.5.3 Revegetation (§3705), Topsoil Salvage, Maintenance, and Redistribution (§3711)

The goal for revegetation efforts in the RPA Area is native community restoration. This refers to the reclamation of disturbed lands to a self-sustaining community of native species which will visually integrate the RPA Area with that of the surrounding open space areas. A sequential visual simulation is provided as Attachment I. Revegetation is designed to control erosion and stabilize slopes against long-term

erosion using plant materials capable of self-regeneration without continued dependence on irrigation, soil amendments, or fertilizer.

Existing native communities in surrounding areas are characterized on north-facing slopes by well-established oak woodland communities with scattered high meadows, and on dry south-facing slopes, chaparral and scrub species. Revegetation will mimic the high meadow communities present on the north-facing slopes of the surrounding areas with scattered areas of shrub and tree plantings that eventually will contribute to the regeneration of oak woodlands. For south-facing slopes, revegetation will mimic the scrub brush communities in adjacent open space areas by seeding native shrubs and grasses and planting areas of shrub cover.

The Amendment incorporates the revegetation measures specified in the Revegetation Plan (Attachment H), which describes soil development and preparation, revegetation techniques, the test plot program, and performance standards for the maintenance and monitoring of revegetation. With respect to test plots, the Amendment also incorporates the Revegetation Test Plot Program As-built Report (Attachment G). Sections 3.5.3.1 through 3.5.3.5 summarize the revegetation process.

3.5.3.1 Soil Development and Topsoil Salvage

Areas to be reclaimed in the RPA Area will consist primarily of overburden rock, which does not provide an ideal substrate for vegetation growth. The Revegetation Plan (Attachment H) details soil development measures to improve the substrate's texture, structure, and nutrient availability, and to promote more effective soil development.

Soil development measures are based on soil samples collected from the RPA Area and other locations in the Quarry. Samples were subjected to laboratory analysis to assess the following characteristics: pH, Total Exchangeable Cations, salinity, Sodium content, Sulfate content, Sodium Adsorption Ratio (SAR) Value, Boron, macronutrients (Nitrogen, Phosphate, Potassium, Calcium, Magnesium, Sulfur), Micronutrients (Iron, Manganese, Copper, Zinc), United States Department of Agriculture (USDA) Soil Textural Classifications, and Organic Matter Content (Percent Dry Weight). The Amendment incorporates the recommendations made in the Revegetation Plan for achieving soil characteristics (soil texture, organic matter content, soil chemistry and nutrient levels) in the RPA Area likely to support native plant communities.

During normal EMSA operations, trees and shrubs are cleared and chipped prior to stripping topsoil. Topsoil is harvested and stockpiled during normal EMSA operations. The woody debris is incorporated into the topsoil to increase the level of organic matter in the soil. Approximately 25,000 to 35,000 cubic yards are expected to be available for reclamation purposes in the RPA Area.

Soil used for revegetation will be prepared by mixing 25 percent salvaged topsoil blended with 75 percent overburden material and other materials available onsite as detailed in the revegetation plan. The slopes will have six inches of soil medium comprised of two inches of topsoil blended with four inches of overburden material. This blend should be sufficient to support the grasses, herbs, and shrubs scheduled

for planting there. The benches will support tree and shrub plantings that require deeper soils so 24 inch planting medium is proposed there which includes six inches of salvaged topsoil blended with 18 inches of overburden or other material. Other topsoil treatments are detailed in Section 3.5.3 below, and in the Revegetation Plan (Attachment H). The stockpile area is shown on Figure 3.2-1.

Topsoil will be moved directly to an area of active revegetation whenever possible. If harvested topsoil must be stored prior to use in revegetation, it will be stockpiled and clearly labeled. Harvested topsoil will be compacted as little as possible and will only be moved or worked when it is dry. Stockpiles of topsoil or other growth medium intended for use in revegetation efforts will be protected from erosion and weed establishment through the use of hydroseeding with a native erosion control mix and tackifiers, mulches, erosion control blankets, wattles, silt fences, or other soil protection measures.

Where mining activities have compacted topsoil that is not harvested, ripping, discing, or other means will be used in revegetation areas to establish a suitable root zone in preparation for planting. Where access roads, haul roads, or other traffic routes are to be revegetated, all roadbase materials shall be stripped from the road, the substrate shall be ripped or disced as needed to promote establishment of an appropriate root zone, a soil mix containing 25% topsoil or compost will be spread to promote plant growth, and the area will be revegetated.

3.5.3.2 Replanting and Reseeding

Revegetation relies on an adaptive management approach, set forth below, because test plots were constructed in 2008 and will not produce a significant amount of data before some planting must be initiated within the RPA Area. This section describes the species mixes to be used for replanting and reseeding slopes and benches. This section describes a preliminary erosion-control mix that will be used for disturbed areas not yet designated for final reclamation.

Interbench slopes will be reclaimed with a hydroseed mix of native grass, herbaceous, and shrub species will be used. The preliminary species mix is shown in the table below. This species mix is known to perform well in other areas of the Quarry, and will be utilized until test plot results can be used to further refine and expand the species selection. Hydroseeding will utilize a homogenous slurry of mulch, fertilizer, seed, and a binding agent over areas to be revegetated.

Revegetation will occur in phases concurrently with the completion of individual overburden lifts. Plant species selected for revegetation consist of native species known to occur on the quarry property. Preliminary species selection is shown in the two tables below and include species common in the area that have proven to be successful in past revegetation efforts. The revegetation process will be an adaptive management approach, however, and results from the test plots and from other revegetation sites will be used to further refine the species selection and revegetation effort. Final species selection may include native plants observed within the greater quarry property which are provided in the Master Plant List (Attachment I).

Preliminary species for general slope hydroseeding		
SCIENTIFIC NAME	COMMON NAME	Suitable aspect (different mixes may be utilized on north-facing [N] vs. south-facing [S] areas)
SHRUBS		
<i>Adenostoma fasciculatum</i>	chamise	S
<i>Artemisia californica</i>	California sagebrush	N and S
<i>Baccharis pilularis</i>	coyote brush	N and S
<i>Ceanothus cuneatus</i>	buckbrush	N and S
<i>Eriogonum fasciculatum</i>	California buckwheat	S
<i>Heteromeles arbutifolia</i>	toyon	N
<i>Mimulus aurantiacus</i>	sticky monkeyflower	N
<i>Salvia leucophylla</i>	purple sage	S
<i>Salvia mellifera</i>	black sage	S
GRASSES AND HERBS		
<i>Elymus glaucus</i>	blue wildrye	N and S
<i>Eschscholzia californica</i>	California poppy	N and S
<i>Heterotheca grandiflora</i>	telegraph weed	N and S
<i>Lotus scoparius</i>	deerweed	N and S
<i>Lupinus nanus</i>	sky lupine (innoc.)	N and S
<i>Nassella pulchra</i>	purple needlegrass	N and S
<i>Plantago erecta</i>	California plantain	N and S
<i>Vulpia microstachys</i>	three weeks fescue	N and S

Benches will be reclaimed with tree and shrub areas. Planting areas dominated by tree species will generally be located on north-facing and east-facing benches, where temperatures will be most suitable to support trees. These benches will provide approximately 13.3 acres of available planting areas. A target quantity of approximately 975 oak trees are scheduled to be planted in these areas in addition to other tree species. South-facing benches will generally be planted with shrubs, supplemented in some areas supplemented with grey pine (*Pinus sabiniana*), a native tree species that is tolerant of very dry conditions.

Trees and shrubs will be planted in benches or slopes as container plants or acorns to encourage re-establishment of a vegetative community similar in structure to that of the surrounding areas. Plantings will occur on the benches where a deeper layer of soil treatment materials is applied to ensure adequate space for root development. These deeper soils with container plantings will be prepared on contoured benches,

while slopes will be covered with shallower soils and hydroseeded. To the extent practicable, trees and shrubs to be planted will be obtained from seeds collected on-site or from local sources.

As with hydroseeding, adaptive management is used to refine the most effective tree and shrub species, spacing and location, and species to use in replacement plantings if necessary. A preliminary list of trees and shrubs to be planted on benches is shown in the table below. Although no evidence of Sudden Oak Death (SOD) syndrome has been observed in the RPA Area, the majority of the oak trees in the RPA Area are foliar hosts of *Phytophthora ramorum*, the pathogen that causes SOD syndrome. While plantings will include some foliar hosts such as coast live oak, toyon and California coffeeberry due to their predominance in adjacent natural areas, species not known to be susceptible to *P. ramorum* (such as Valley oak and blue oak) will be more heavily represented in plantings than in surrounding natural areas to reduce the susceptibility of the revegetation program.

Preliminary list of trees and shrubs for planting on RPA Area benches		
SCIENTIFIC NAME	COMMON NAME	Potential <i>P. ramorum</i> host?
TREES (may use acorns instead of container planting for some oaks)		
<i>Arbutus menziesii</i>	Pacific madrone	yes
<i>Pinus sabiniana</i>	grey pine	no
<i>Quercus agrifolia</i>	coast live oak	yes
<i>Quercus chrysolepis</i>	canyon live oak	yes
<i>Quercus douglasii</i>	blue oak	no
<i>Quercus lobata</i>	Valley oak	no
<i>Quercus wislizenii</i>	interior live oak	no
SHRUBS*		
<i>Cercocarpus betuloides</i>	mountain mahogany	no
<i>Heteromeles arbutifolia</i>	toyon	yes
<i>Quercus berberidifolia</i>	scrub oak	no
<i>Rhamnus californica</i>	California coffeeberry	yes
<i>Rhamnus crocea</i>	redberry	no
<i>Ribes californicum</i>	hillside gooseberry	no
<i>Ribes malvaceum</i>	chaparral currant	no

At least 10% of the total revegetation area will be planted in tree and/or shrub planting areas subject to the above mix (or as later refined). Shrubs will be planted at approximately 4.5-foot spacing (680 shrubs per acre) and trees at 9-foot spacing (up to 170 trees per acre) in the designated areas. The need for herbivory protection

for specific species will be evaluated based on the results of test plots and early stages of the proposed reclamation project.

Weed mats may be placed around planted trees to reduce competition with revegetation species. The need for irrigation will be assessed during the test plot program. By planting a large number of acorns without irrigation, hearty oak trees will be selected for increasing the chances of their survival. However, if monitoring of the early revegetation stages and test plots indicate significant losses of plant material that threatens achievement of performance criteria, the need for irrigation will be re-evaluated.

A preliminary erosion control stage may be incorporated prior to final revegetation on slopes and benches. The native seed mix below includes species proven successful in other revegetation efforts in the Quarry to provide erosion control and initial establishment of native grasses and herbaceous species, until more specific revegetation measures are developed based on test plot data and plant and seed availability.

Erosion control seed mix		
SCIENTIFIC NAME	COMMON NAME	PURE LIVE SEED (lbs / acre)
<i>Bromus carinatus</i>	California brome	16.00
<i>Elymus glaucus</i>	blue wildrye	10.00
<i>Lupinus nanus</i>	sky lupine (innoc.)	5.00
<i>Nassella pulchra</i>	purple needlegrass	8.00
<i>Plantago erecta</i>	California plantain	3.00
<i>Trifolium wildenovii</i>	tomcat clover (innoc.)	3.00
<i>Vulpia microstachys</i>	three weeks fescue	8.00
TOTAL		53.00

3.5.3.3 Test Plot Program

A test plot program has been established at the Quarry to improve revegetation success in areas to be reclaimed. The test plot program is detailed in the Revegetation Test Plot Program As-built Report (Attachment F). The objective of test plots is to assess the response of different native seed mixes and a palette of restoration plantings to various soil treatment blends and depths, using several different materials available in the RPA Area, in the larger Quarry area, or from offsite. Test plot variables include testing the effectiveness of mycorrhizal inoculants for increasing plant growth and regeneration. The information derived from the test plot program will guide the revegetation efforts in the RPA Area. The test plot program is based on sixteen test plots constructed on top of bare graded overburden rock at two different locations within the Quarry in the fall of 2008, including within the RPA Area.

Test plots 13, 14, and 15 are located within the EMSA and are temporary by design. They will provide useful results on germination and productivity on the north facing

slopes of the EMSA. They will be dismantled after collecting one to two years of data as they are in within the RPA area. The thirteen remaining test plots will be monitored annually for five years to assess species success on the various soil types, invasive plant issues, the success of the mycorrhizal inoculant, herbivory levels, and the need for irrigation. Results of the test plot monitoring will be used to further guide the phased reclamation efforts.

3.5.3.4 Maintenance

Maintenance of revegetation areas consists of inspection and replacement of herbivore protection materials as needed, reseeding or replanting unsuccessful revegetation efforts, weed control to limit the extent of noxious weeds, and repair of erosion damage.

If revegetation is not successful with regard to the performance standards outlined in Section 3.5.3.5 below within five years following initial seeding, seeding areas will be reevaluated to determine measures necessary to improve revegetation performance. If necessary, areas will be reseeded and/or replanted with methods modified as needed. This may include the use of container stock and irrigation or simply reseeding during a wet winter season. If further revegetation efforts still do not yield satisfactory results, additional reseeding or other intervention methods may be required. Significant rills or gullies will be addressed by remedial action, including reseeding areas with an approved erosion control seed mix, and if necessary, slope stabilization measures.

Weed controls will be applied to reduce or eliminate the occurrence of undesirable non-native invasive plant species where active and natural revegetation is taking place. Reference plots have been implemented in undisturbed natural grassland habitat to assess native and non-native species richness and cover for weedy plants. These studies showed that non-native and invasive species accounted for over 50% of the vegetative cover. Success criteria have been developed that take this data into account. Invasive species listed in the “High” category of the California Invasive Plant Council’s inventory (Cal-IPC 2006) will be considered problematic and will be targeted during maintenance if they exceed the designated threshold of 30% cover. Invasive plant species typically found in the vicinity of the RPA Area include yellow star thistle (*Centaurea solstitialis*, annual), black mustard (*Brassica nigra*, annual), stinkwort (*Dittrichia graveolens*, annual), pampas grass (*Cortaderia* spp., perennial), and fennel (*Foeniculum vulgare*, perennial).

3.5.3.5 Monitoring

Implementation of revegetation activities will be monitored by a qualified individual. Records will be kept of soil replacement, addition of soil amendments as determined to be necessary, and hydroseeding. Hydroseeding will be detailed to identify the date of application and the location where various seed mixes are applied. Additionally, the installation of tree and shrub plantings will be detailed to identify the location and approximate area of those planting areas and the number of trees or shrubs planted or seeded.

To document revegetation success, revegetation areas will be monitored periodically until performance standards have been met for two consecutive years. Revegetation sites shall be identified on a map and monitored to assure that standards are adequately achieved to within a minimum of 80 percent confidence level. The revegetation efforts will be considered complete when the success criteria have been fulfilled.

Monitoring on tree and shrub planting areas will randomly select 5% of the total area of tree and shrub areas within each stage phase for five years following installation. Both north-facing slopes and south-facing slopes will be represented in sampling. Monitors will count all trees and shrubs surviving in each area. The boundary of the area monitored will be mapped and the total number of trees and shrubs present will be used to estimate tree and shrub density. Additionally three 20-meter transects will be randomly placed in each tree and shrub area previously selected for sampling. A monitor will walk the transect, assessing presence of cover of tree or shrub species at one-meter intervals, resulting in 20 observations per transect or 60 per tree planting bench. These data will be used to determine if the percent cover performance criteria is met.

Monitoring of hydroseeded areas will occur based on the random placement of a minimum of 24 square meter quadrats throughout the areas seeded with grasses, herbs, and shrubs to determine percent cover by each species. At least one quadrat will be sampled for every two acres installed. The percent cover by species will be used to evaluate if the hydroseeded areas are meeting performance standards for cover and species richness. Hydroseeded areas will be monitored in late spring to ensure that most plants will be identifiable to the species level.

Monitoring of revegetation success and invasive plants will occur periodically, so long as monitoring is required, by a qualified biologist with experience in plant identification. After monitoring data is collected, a report summarizing the success of revegetation efforts, comparison of data to performance standards, any observed obstacles to achieving performance standards, and any remedial actions recommended will be prepared and submitted to the operator by October 15 of that year. This will allow for proper timing of remedial plantings and/or seeding if determined to be necessary. Monitoring for performance standards will begin as soon as revegetation is completed for a given area of the EMSA.

Performance standards are used to describe species richness, percent cover, and stem density for tree and shrub areas as well as the hydroseed areas. Performance standards represent anticipated conditions five years after installation, based on a study of reference sites in the vicinity of the RPA Area and identified in Attachment H. The standards below reflect the expected vegetative growth in the first five years under the conditions present in revegetation areas.

Performance standards for EMSA revegetation										
		TREE & SHRUB AREAS (north-facing and east-facing benches)			SHRUB AREAS (south-facing benches, will include scattered grey pine)			HYDROSEED AREAS shrub/grassland between areas		
		Tree	Shrub	Herb	Tree	Shrub	Herb	Tree	Shrub	Herb
Proposed EMSA Standards	Richness (<i>avg. native species per acre</i>)	1	2	3	0	2	2	0	1	3
	Canopy Cover	20%	20%	50%	0%	40%	20%	0%	5%	50%
	Density (<i>stems per acre</i>)	102	408	-	0	272	-	-	-	-

Performance standards for weed control also have been incorporated. The density of weeds (non-native invasive plants) will be assessed within the grassland quadrats described above. For the purposes of site maintenance and monitoring, non-native plants listed on the California Invasive Plant Council Inventory (Cal-IPC 2006) as “High” will be considered invasive weeds. If invasive weeds are found to exceed 30% of the relative cover over all sampled quadrats, weed abatement activities must commence. Weed control methods may include chemical and mechanical removal techniques depending on the species and number of individuals encountered. Priorities in weed abatement should focus on those species listed as High in addition to species that directly threaten the successful establishment and survival of native species. The percent cover of weeds, abatement measures recommended and undertaken, and other observations on weed control will be included in annual vegetation monitoring reports. Weed abatement will cease once performance standards have been met for each phase of revegetation efforts.

3.6 Drainage, Diversion Structures, Waterways and Erosion Control (§3706), and Stream Protection, Including Surface and Groundwater (§3710)

The EMSA is designed to control surface runoff to protect surrounding land and water resources in accordance with the Porter-Cologne Water Quality Control Act, the federal Clean Water Act, and other applicable local, state and federal requirements. These goals are achieved through a series of Best Management Practices (BMPs) pursuant to the Erosion Control Plan Report (Attachment D) and Drainage Report (Attachment F). Drainage and erosion controls apply at all stages of operation and reclamation, and are designed to exceed the 20-year storm event.

Temporary erosion control measures will be used in the RPA Area during the course of and immediately following reclamation. These measures will focus on control of sediment, the primary water quality pollutant with the potential to be generated from the EMSA. These measures include desiltation basins, drainage ditches, silt fencing and hydroseeding. Desiltation basins will be removed, recontoured and revegetated when no longer needed for sediment control due to the establishment of vegetative cover.

Desiltation basins and silt fencing will be installed around the perimeter of the EMSA, as detailed in the Erosion Control Plan Report (Attachment D) and Drainage Report (Attachment F). (See Figure 3.6-1.) Desiltation basins are sized according to local and state requirements. The majority of EMSA runoff will be conveyed to one of the perimeter desiltation basins by a series of ditches and downdrains. Because portions of the ditches within the perimeter road and the downdrains will have a steep gradient, they will be lined with riprap or other erosion-resistant material to prevent erosion. These drainage facilities have been sized to convey the tributary 100-year flow.

The manner of topsoil placement has been designed to ensure a stable reclamation surface. Soil development includes the blending of topsoil with the overburden substrate to establish a stable reclamation surface which minimizes the potential for soil instability and surficial erosion. Hydroseeding will be used on the reclaimed slopes, benches, and pads. Prior to final reclamation, a preliminary erosion control stage will be incorporated consisting of the native seed mix shown in Section 3.5.3.2. The mix includes species that have proven successful in other revegetation efforts in the quarry, and are recommended to provide erosion control and initial establishment of native grasses and herbaceous species.

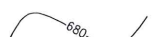

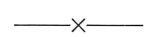
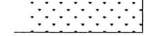

Permanent erosion control measures include the drainage ditches and downdrains described above, and long-term revegetation as described in Section 3.5.3.2. The temporary desiltation basins and silt fencing will be removed as the progress of revegetation allows. Long-term revegetation includes hydroseeding of finished slopes with a mixture of native grasses, herbaceous plants, and shrubs will provide surface cover and erosion control for the new slopes. Tree and shrub planting areas will be located on benches of the revegetation areas to encourage the long-term development of an oak savannah on north-facing slopes, or native scrub community on south-facing slopes.

The facility also is covered by a Storm Water Pollution Prevention Plan (SWPPP) which is maintained as a requirement of the operator's General Storm Water Permit. The SWPPP contains additional BMPs for erosion control, and for the management and control of potential contaminants. The SWPPP includes provisions for preventing discharge of potential pollutants resulting from equipment operation, fueling or maintenance and includes response measures.

Prior to the release of financial assurances, disturbed slopes in the RPA Area must meet revegetation and erosion control performance standards. These standards have been designed to minimize the potential for stormwater runoff and erosion.

Maintenance and monitoring will include identification and repair of erosion damage. Remedial measures will be applied as identified below and in Attachment F. Performance criteria and slope treatment for erosion control is based on the qualitative descriptions and remedial measures described in the table below. Field investigation will determine the need for remedial measures based on observations. In general, areas receiving an average score of Class 3 or 4 will receive slope treatment. Any observable reason for failure will be noted and the appropriate remedial measure stated as part of the annual monitoring report.

EROSION CONTROL LEGEND

-  PROPOSED CONTOUR AND ELEVATION LABEL
-  EXISTING CONTOUR AND ELEVATION LABEL
-  PERIMETER SILT FENCING PER DETAIL ON SHEET 5
-  HYDROSEED / MULCH
-  PROPOSED RIPRAP PAD

EROSION CONTROL NOTES

1. ALL EXPOSED AND DISTURBED AREAS MUST BE SEEDED AS PER SPECIFICATIONS BY WRA, INC.
2. TOPS OF ALL SLOPES TO BE DIKED OR TRENCHED TO PREVENT WATER FROM FLOWING OVER THE CREST OF SLOPES.
3. ALL FILL SLOPES SHALL BE COMPACTED AND LEFT IN A SMOOTH AND FIRM CONDITION CAPABLE OF WITHSTANDING WEATHERING.
4. ALL STORM DRAINAGE STRUCTURES SHALL BE INSTALLED WITH EFFECTIVE ENTRANCE & OUTFALL EROSION CONTROLS, E.G. SACKED CONCRETE RIP-RAP. ENERGY DISSIPATORS SHALL BE INSTALLED AT ALL DITCH OUTFALLS. WHERE OUTFALLS ARE NOT INTO AN EXISTING CREEK OR WATER COURSE, RUNOFF SHALL BE RELEASED TO SHEET FLOW.

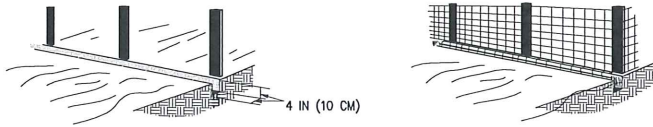
Not to Scale
Locations shown on this map are approximate

MATCHLINE - SEE BELOW RIGHT

FOR PLAN CHECK ONLY

MATCHLINE - SEE ABOVE LEFT

1. SET POSTS AND EXCAVATE A 4 BY 4 IN (10 BY 10 CM) TRENCH UPSLOPE FROM AND ALONG THE LINE OF POSTS.
2. STAPLE FABRIC FENCING TO THE POSTS.
3. ATTACH THE FILTER FABRIC TO THE WIRE FENCE AND EXTEND IT INTO THE TRENCH.
4. BACKFILL AND COMPACT THE EXCAVATED SOIL.



DETAIL: SILT FENCE
NOT TO SCALE

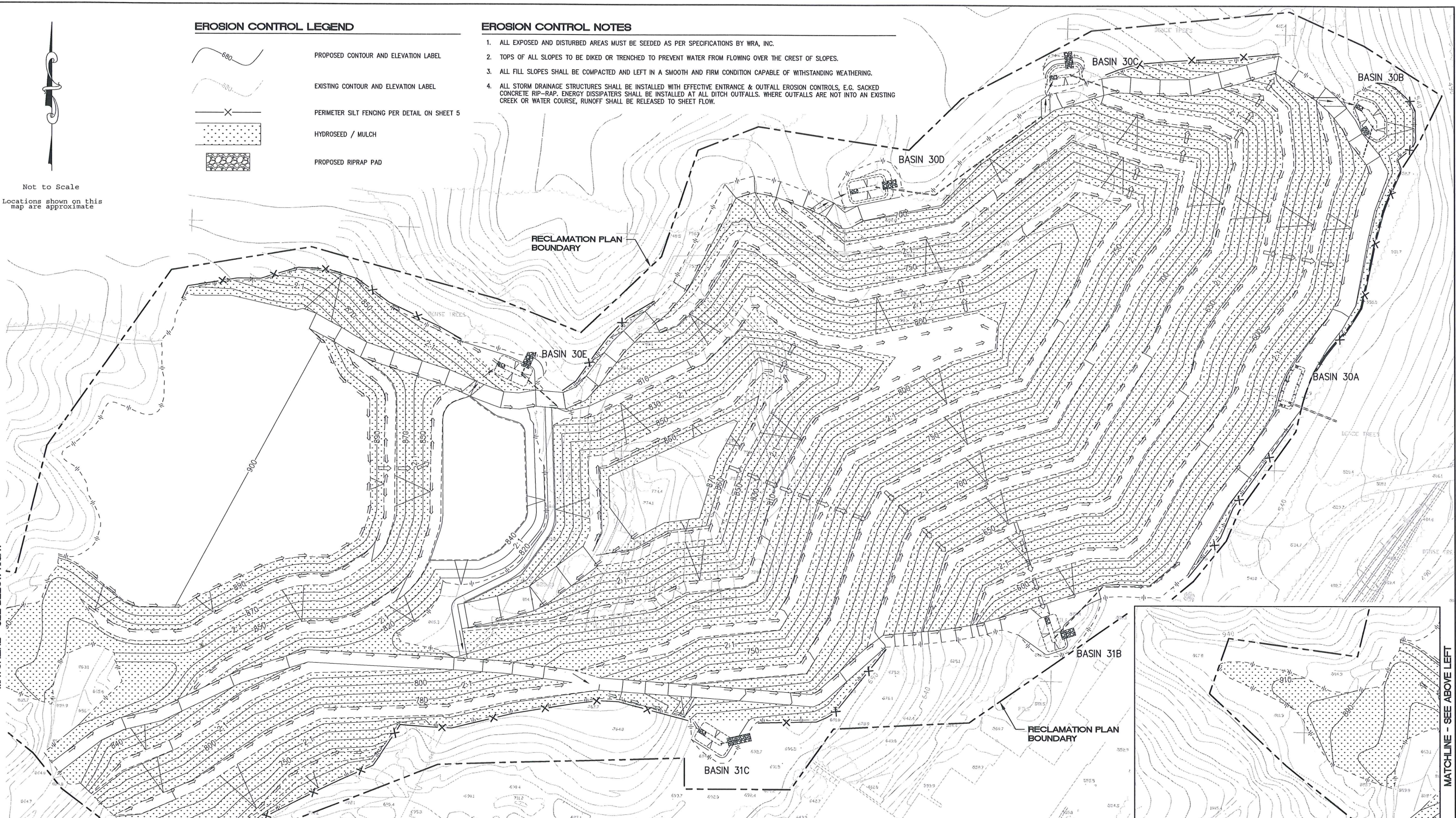


OPERATOR		SHEET INDEX	
NAME:	LEHIGH SOUTHWEST CEMENT COMPANY	SHEET 1	COVER SHEET / NOTES / DETAILS
ADDRESS:	24001 STEVENS CREEK BLVD CUPERTINO, CA 95014	SHEET 2	PHASE A
TELEPHONE:	408-996-4227	SHEET 3	PHASE B
SHORT LEGAL:	SEC 18 T7S R2W MDBM; W 1/4 & SE 1/4 SEC 17 T7S R2W MDBM	SHEET 4	PHASE C
A.P.N.:	351-09-022; 351-10-005, 037, 038	SHEET 5	EROSION CONTROL MEASURES (ALL PHASES)
SITE ADDRESS:	24001 STEVENS CREEK BLVD. CUPERTINO, CA 95014	SHEET 6	POST-RECLAMATION PLAN
		SHEET 7	PHASE A/B CROSS-SECTIONS
		SHEET 8	PHASE C CROSS-SECTIONS
		SHEET 9	OVERALL BOUNDARY/EASEMENTS

ChangConsultants
Civil Engineering-Hydrology-Hydraulics-Sedimentation
P.O. Box 9496 T: 858.692.0760
Rancho Santa Fe, CA 92067 F: 858.832.1402

**PERMANENTE QUARRY
EAST MATERIALS STORAGE AREA
EROSION CONTROL MEASURES
(ALL PHASES)**

REVISION 1	DATE	Figure 3.6-1	SHEET 5 OF 9
REVISION 2	DATE		
REVISION 3	DATE	CO. FILE	



QUALITATIVE DESCRIPTIONS OF SOIL SURFACE STATUS	
CLASS 1:	No soil loss or erosion; topsoil layer intact; well-dispersed accumulation of litter from past year's growth plus smaller amounts of older litter.
CLASS 2:	Soil movement slight and difficult to recognize; small deposits of soil in form of fans or cones at end of small gullies or fills, or as accumulations upslope of plant crowns or behind litter; litter not well dispersed or no accumulation from past year's growth.
CLASS 3:	Soil movement or loss more noticeable; topsoil loss evident, with some plants on pedestals or in hummocks; rill marks evident, poorly dispersed litter and bare spots not protected by litter.
CLASS 4:	Soil movement and loss readily recognizable; topsoil remnants with vertical sides and exposed plant roots; roots frequently exposed; litter in relatively small amounts and washed into erosion protected patches.

REMEDIAL MEASURES FOR EROSION CONTROL	
CLASS 1:	No action necessary.
CLASS 2:	Monitor to see if any further deterioration and action is required.
CLASS 3:	Any rills or gullies in excess of 8 square inches in cross sectional area and more than 10 linear feet located on finished slopes shall be arrested using straw mulch or the equivalent.
CLASS 4:	Replant and cover with straw mulch and install silt fences. If necessary, regrade and compact with equipment.

3.7 Building, Structure and Equipment Removal (§3709)

With the exception of equipment required for reclamation purposes, all equipment and structures will be removed from the RPA Area prior to final reclamation. This includes all rolling stock such as loaders, dozers, excavators, haul trucks, storage vans and water trucks. All surplus equipment and supplies associated with mining activity will be transported outside the project area. All trash and miscellaneous debris will be collected and hauled to an appropriate waste disposal facility pursuant to the state and local health and safety ordinances. Suitable access roads will remain to allow for proper monitoring and maintenance of the reclamation effort.

3.8 Public Health and Safety (§2712(c))

Post-extraction public health and safety will be protected in accordance with County standards for undeveloped land. During operations in the RPA Area, public access will be controlled in the following manner:

- Access restricted to the Quarry 24 hours per day through a gated entrance manned by security guards.

- Prior to encountering the guard gate on Permanente Road, there are two roads leading toward the RPA area. Access provided by these roads is controlled through locked gates.
- Steep slopes and dense vegetation prevent access to the project area from offsite lands.

Following final reclamation of the RPA Area, public access will be controlled in the following manner:

- Access roads will be blocked with a gate, large rocks or other control mechanism that will prohibit vehicular entry.
- Signs will be posted at key locations around the perimeter of the project area adjacent to undeveloped lands. These signs will warn “Private Property”, “No Trespassing”, and “Danger: Steep Slopes”.
- All final slopes will be certified by a geotechnical engineer to be suitable for the proposed end use.

3.9 Effect of Reclamation on Future Recovery of Mineral Resources

This Amendment does not preclude future extraction or overburden placement activities within the RPA Area, other areas of the site or on surrounding lands.

3.10 Financial Assurances (§3702)

Financial assurances will be required to ensure that reclamation is performed in accordance with this Amendment. The financial assurance may be in the form of surety bonds, irrevocable letter of credit, trust funds, or other forms of financial assurances approved by the Lead Agency. The financial assurance is reviewed annually by the operator, the lead agency and the Office of Mine Reclamation to determine if adjustments to the estimate are necessary.

The County approved the financial assurance estimate dated April 2008 which covers all disturbed lands within the Permanente ownership as well as activities proposed under the Permanente Quarry Reclamation Plan Amendment dated March 2007. This estimate, totaling \$9,208,771 was provided to the County with a letter dated April 21, 2008. The RPA Area generally was included within the bonded area and activities covered under this approved financial assurance estimate, and the financial assurances will be reviewed to determine whether further adjustment is necessary.

3.11 Statement of Responsibility

Lehigh Southwest Cement Company accepts responsibility for reclamation as set forth in this Amendment.

Jeffrey Brummert, Vice President

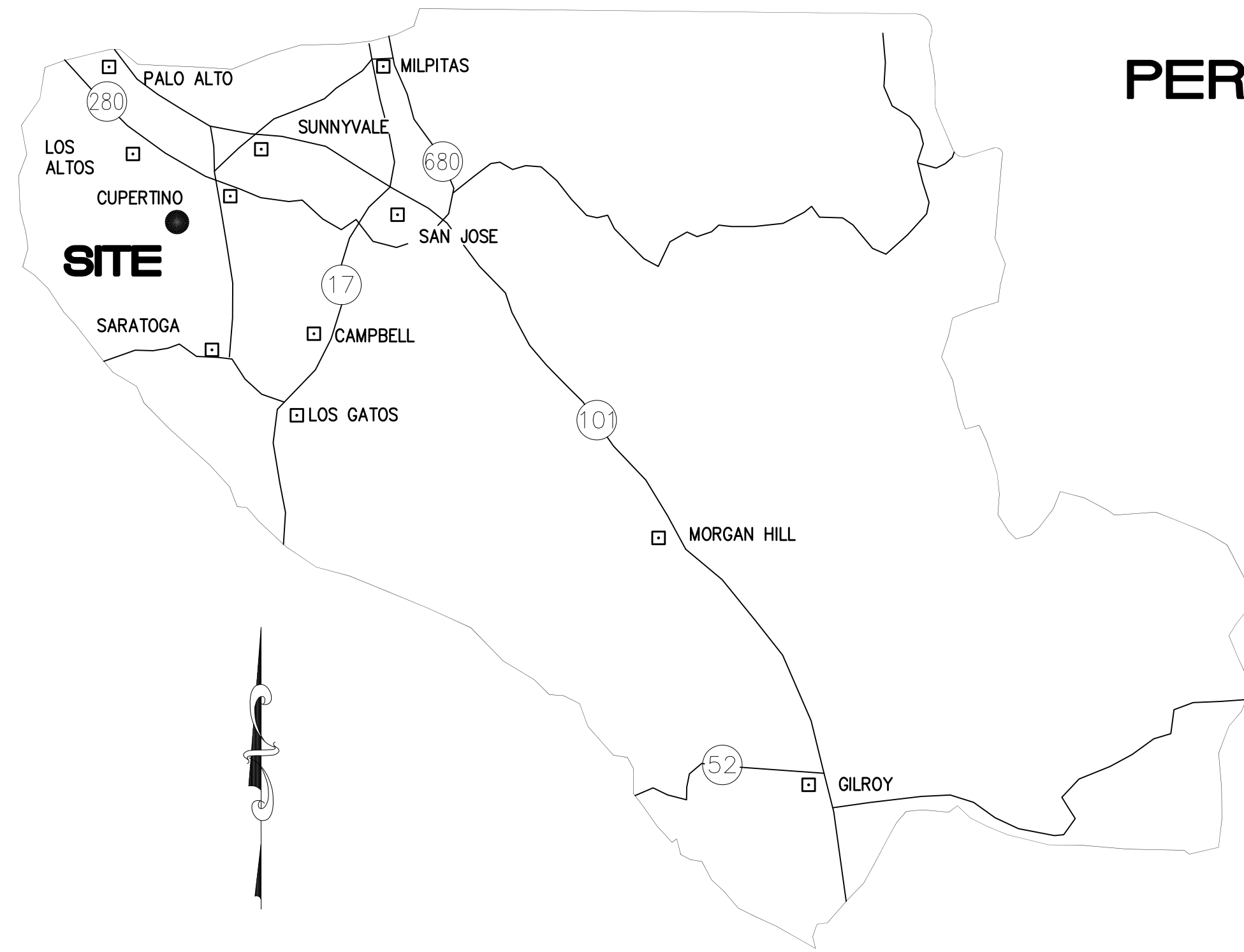
Dated: April ____, 2009

3.12 Administrative Requirements

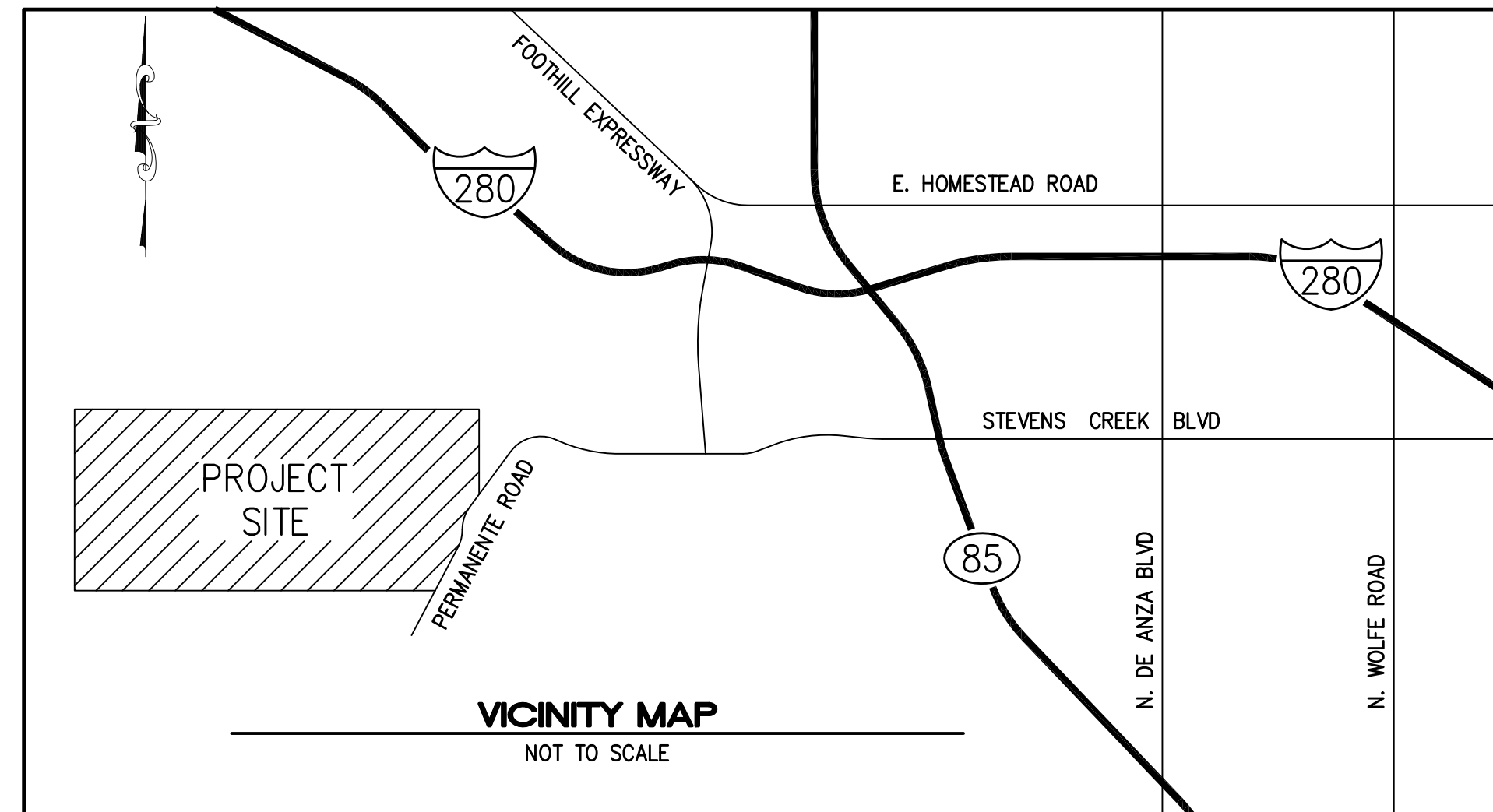
Lead Agency Information:

Lead Agency: County of Santa Clara Planning Office
Staff Contact: Gary Rudholm, Senior Planner
Telephone: (408) 299-5770
Address: 70 West Hedding Street
East Wing 7th Floor
San Jose, CA 95110

RECLAMATION PLAN FOR: PERMANENTE QUARRY - EAST MATERIALS STORAGE AREA SANTA CLARA COUNTY, CALIFORNIA



COUNTY LOCATION MAP
NOT TO SCALE



VICINITY MAP
NOT TO SCALE

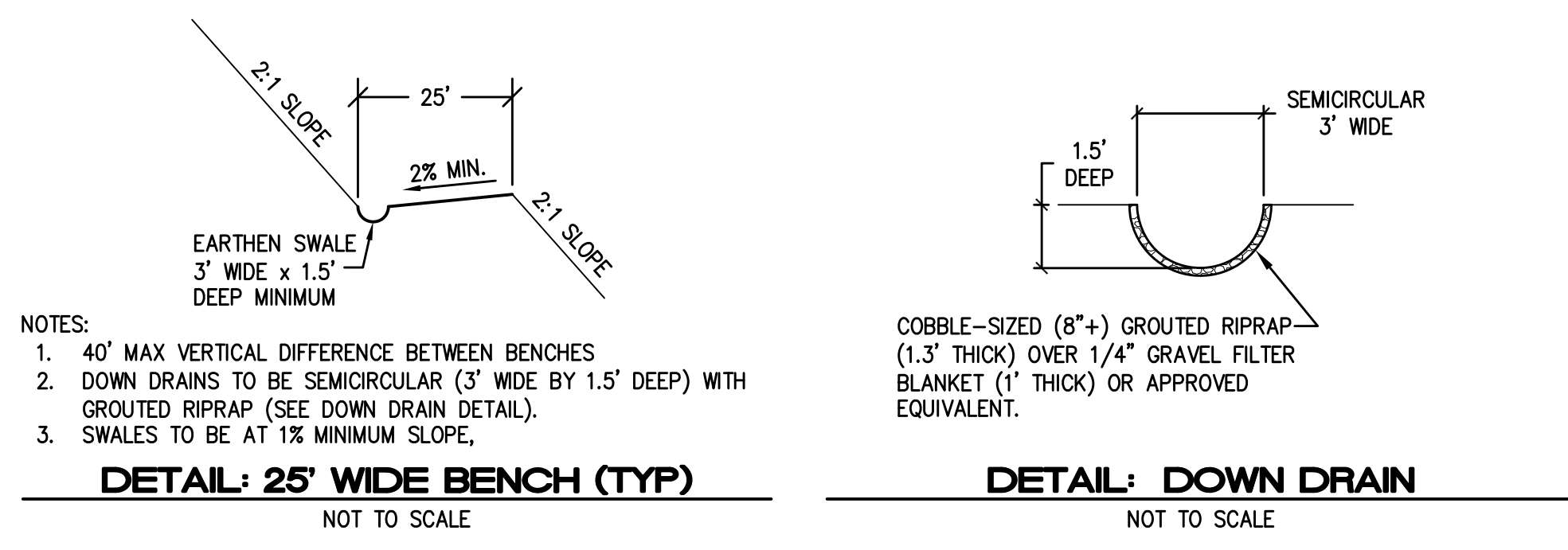
LEGEND

- PROPOSED CONTOUR AND ELEVATION LABEL
- EXISTING CONTOUR AND ELEVATION LABEL
- RECLAMATION PLAN BOUNDARY
- EXISTING EASEMENT
- PERIMETER DAYLIGHT LINE
- PROPOSED 25' WIDE BENCH
- PROPOSED ACCESS ROAD (4" AGGREGATE BASE)
- PROPOSED STORM DRAIN AND RISER
- PROPOSED RIPRAP PAD
- CONCRETE OR DG SWALE (DG TO BE MAINTAINED)
- GENERAL FLOW DIRECTION
- PROPOSED DOWN DRAIN PER DETAIL ON THIS SHEET
- PROPOSED SWALE PER DETAILS ON THIS SHEET (1% MIN. SLOPE)

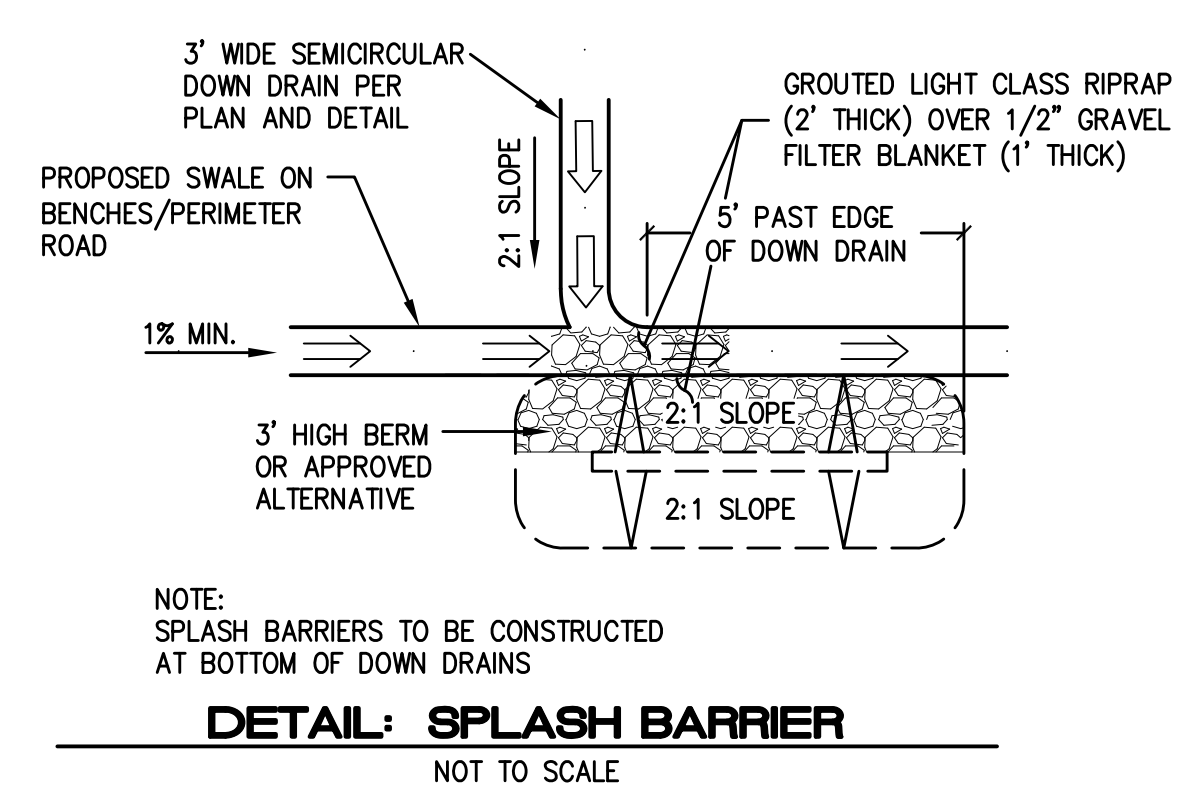
NOTE:
ALL PROPOSED FACILITIES AND THE RECLAMATION CONFIGURATION SHOWN ON THESE PLANS ARE APPROXIMATE ONLY. IN PARTICULAR, SURFACE DISTURBANCE BOUNDARIES ARE NOT EXPECTED TO BE IDENTICAL TO THOSE DEPICTED, ALTHOUGH TOTAL ACREAGE TO BE DISTURBED AND RECLAIMED SHOULD BE SIMILAR TO DEPICTED. WHILE THIS PLAN REFLECTS THE BEST AVAILABLE DATA, DEVELOPMENT MAY VARY DUE TO ACTUAL GEOLOGICAL CONDITIONS ENCOUNTERED, ENGINEERING, AND OTHER CONSIDERATIONS.

THE BASE TOPOGRAPHIC MAPPING USED FOR THESE PLANS IS AT A 10-FOOT CONTOUR INTERVAL. THE ACCURACY IS ONE-HALF THE CONTOUR INTERVAL.

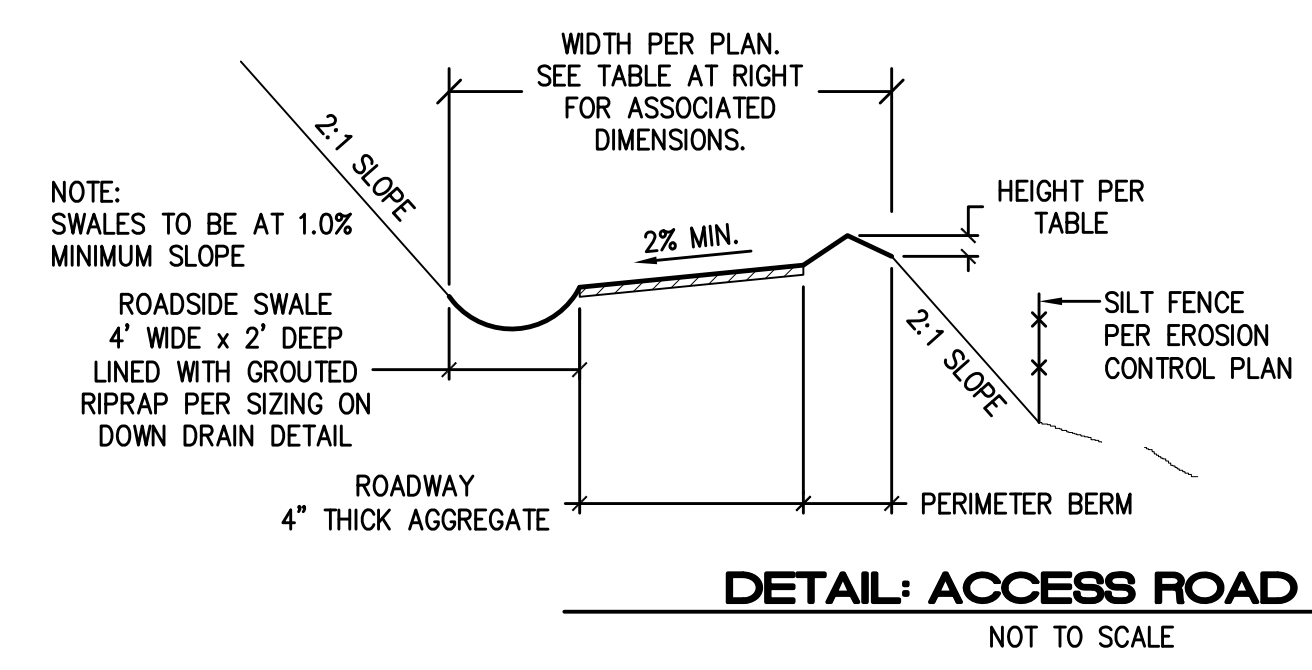
THE FLOWLINE ELEVATIONS ON THESE PLANS ARE APPROXIMATE. THE FINAL ELEVATIONS CAN BE ADJUSTED BASED ON THE FINAL CONTOURS.



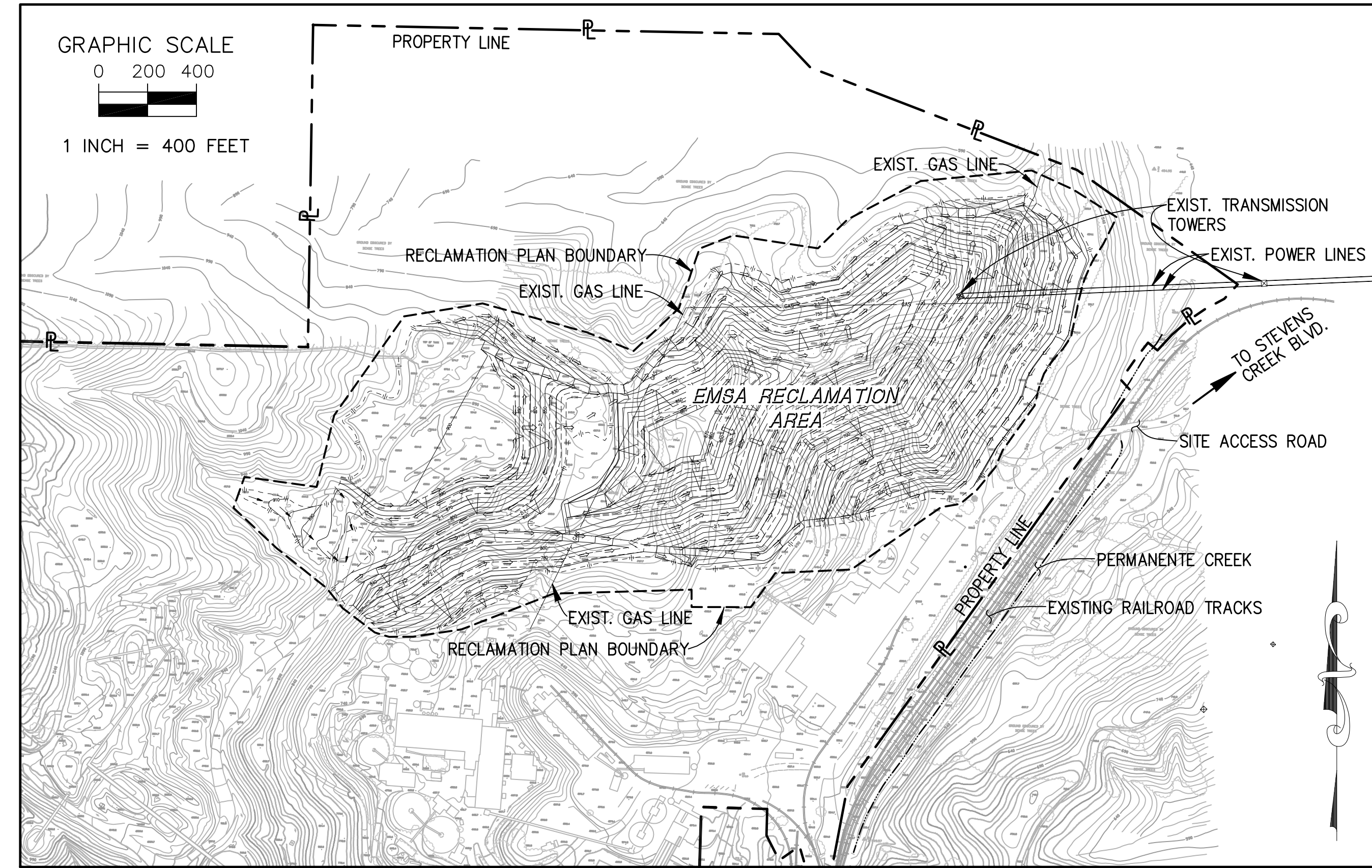
- NOTES:**
- 40' MAX VERTICAL DIFFERENCE BETWEEN BENCHES
 - DOWN DRAINS TO BE SEMICIRCULAR (3' WIDE BY 1.5' DEEP) WITH GROUDED RIPRAP (SEE DOWN DRAIN DETAIL).
 - SWALES TO BE AT 1% MINIMUM SLOPE.



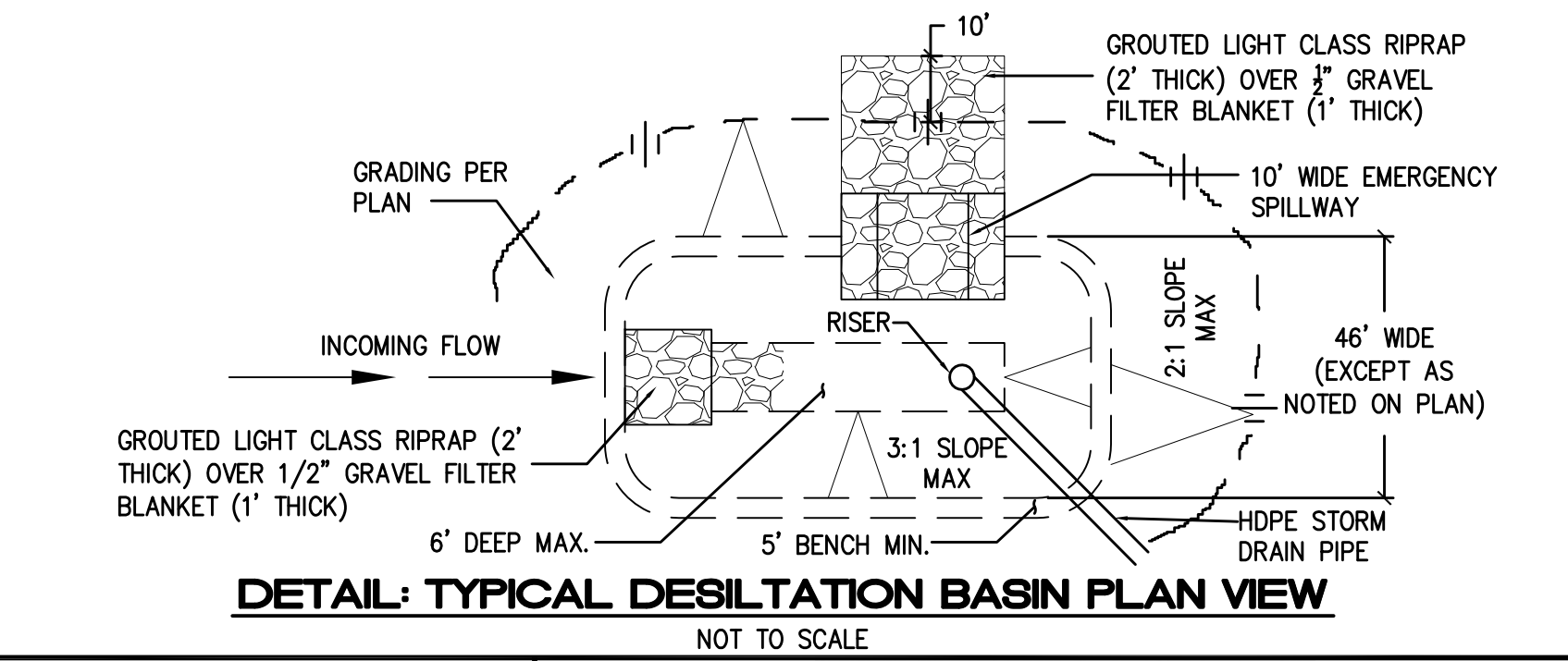
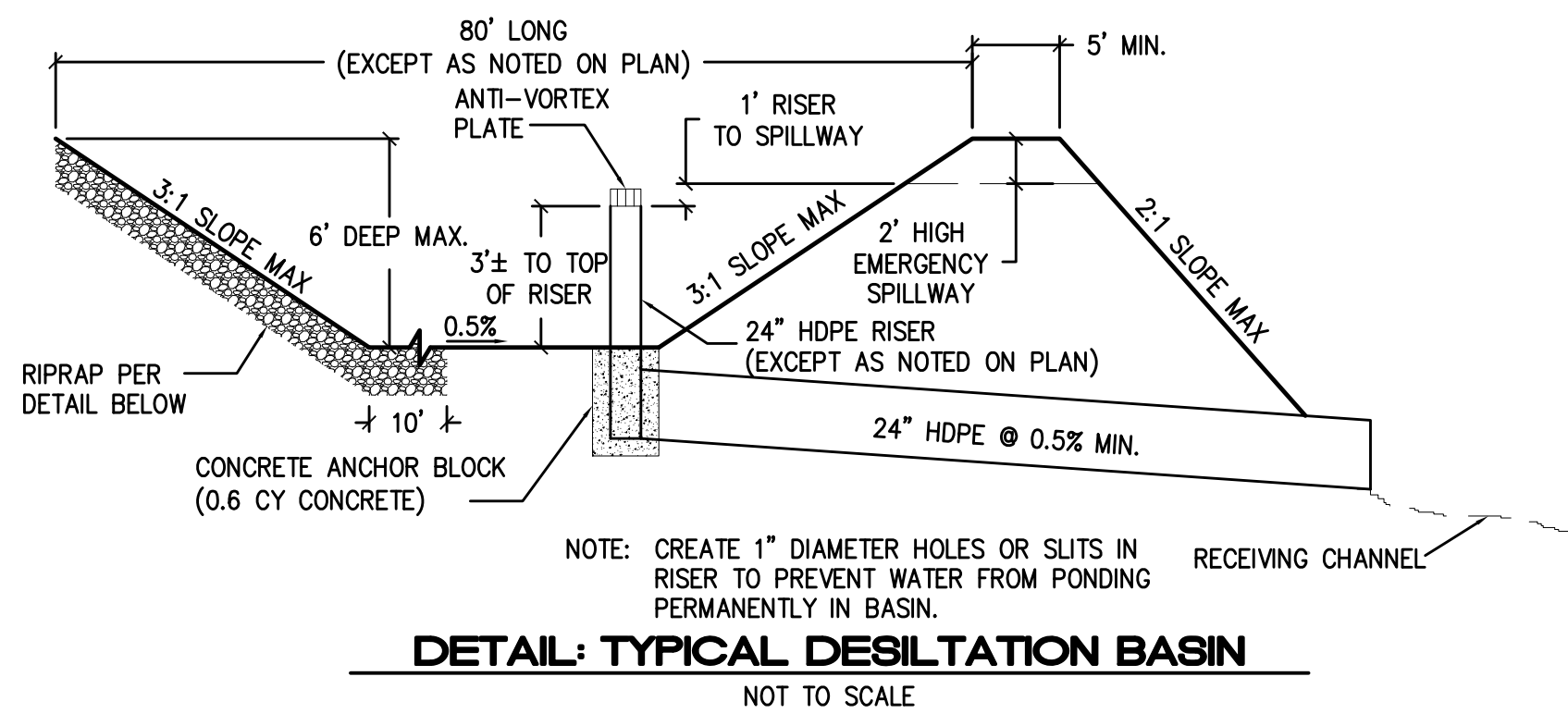
NOTE:
SPLASH BARRIERS TO BE CONSTRUCTED AT BOTTOM OF DOWN DRAINS



ACCESS ROAD DIMENSIONS		
TOTAL WIDTH	PERIMETER BERM (H'xW')	ROADWAY
28'	6'x2'	12'
37'	13'x4.5'	12'
42'	13'x4.5'	12'
52'	6'x2'	12'



SITE MAP
SCALE: 1"=400'



WAYNE W. CHANG, P.E. 46548 DATE _____
 CHANG CONSULTANTS
 P.O. BOX 9496
 RANCHO SANTA FE, CA 92067
 (858) 692-0760
ENGINEER OF WORK



OPERATOR	
NAME:	LEHIGH SOUTHWEST CEMENT COMPANY
ADDRESS:	24001 STEVENS CREEK BLVD CUPERTINO, CA 95014
TELEPHONE:	408-996-4227
SHORT LEGAL:	SEC 18 T7S R2W MDBM; W 1/4 & SE 1/4 SEC 17 T7S R2W MDBM
A.P.N.:	351-09-022; 351-10-005, 037, 038
SITE ADDRESS:	24001 STEVENS CREEK BLVD. CUPERTINO, CA 95014

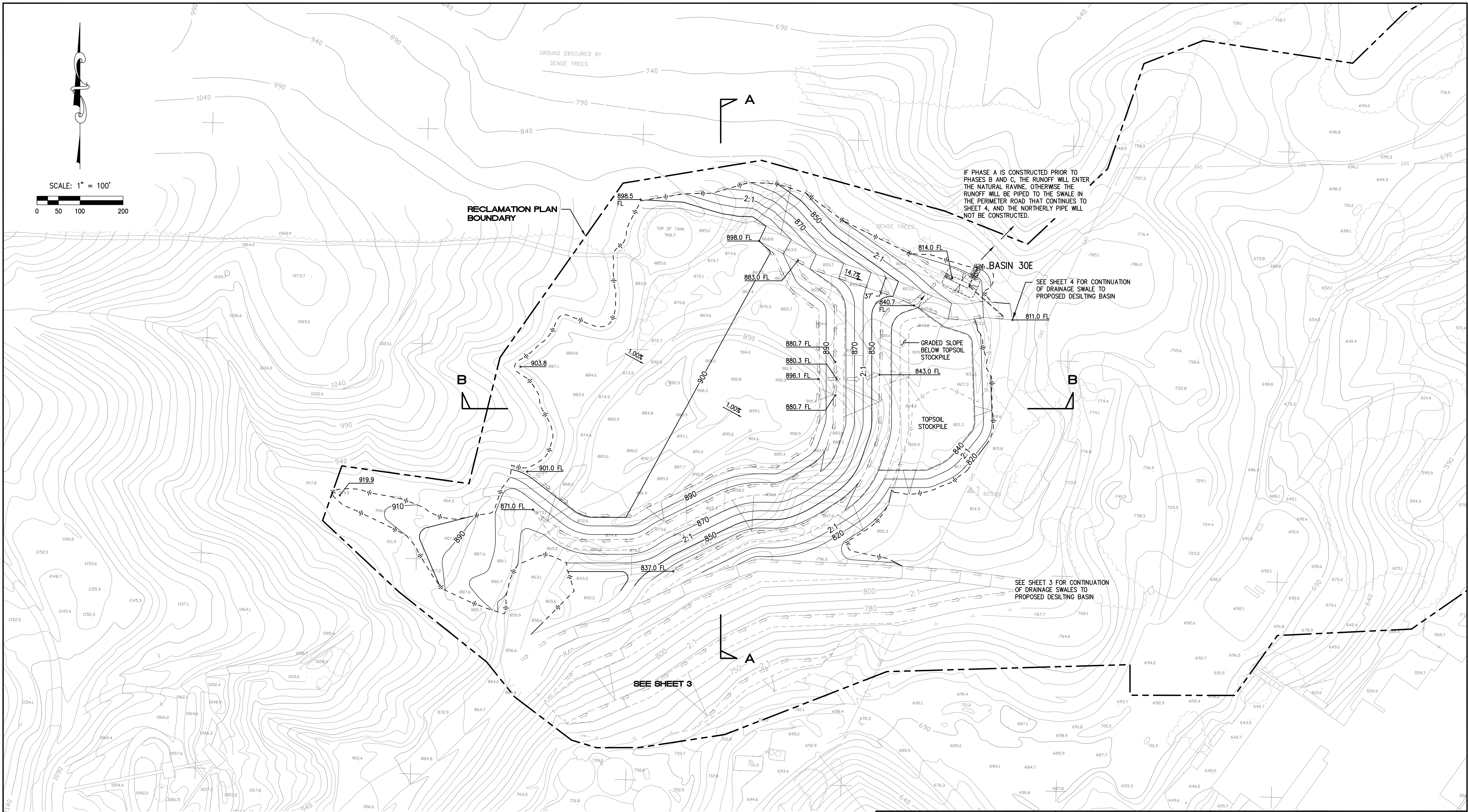
SHEET INDEX	
SHEET 1	COVER SHEET / NOTES / DETAILS
SHEET 2	PHASE A
SHEET 3	PHASE B
SHEET 4	PHASE C
SHEET 5	EROSION CONTROL MEASURES (ALL PHASES)
SHEET 6	POST-RECLAMATION PLAN
SHEET 7	PHASE A/B CROSS-SECTIONS
SHEET 8	PHASE C CROSS-SECTIONS
SHEET 9	OVERALL BOUNDARY/EASEMENTS

Civil Engineering-Hydrology-Hydraulics-Sedimentation
P.O. Box 9496 T: 858.692.0760
Rancho Santa Fe, CA 92067 F: 858.632.1402

PERMANENTE QUARRY EAST MATERIALS STORAGE AREA COVER SHEET / NOTES / DETAILS

REVISION 1	DATE		SHEET 1
REVISION 2	DATE		OF 9
REVISION 3	DATE	CO. FILE	

FOR PLAN CHECK ONLY
CHANG CONSULTANTS
858.692.0760



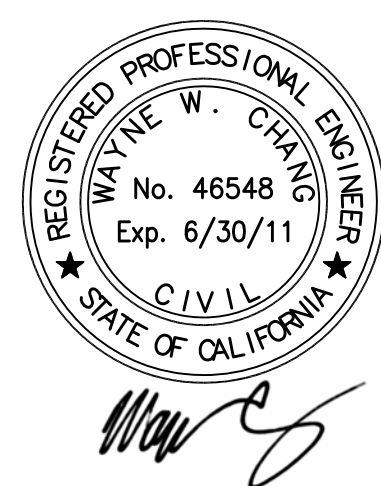
SCALE: 1" = 100'

IF PHASE A IS CONSTRUCTED PRIOR TO PHASES B AND C, THE RUNOFF WILL ENTER THE NATURAL RAVINE. OTHERWISE THE RUNOFF WILL BE PIPED TO THE SWALE IN THE PERIMETER ROAD THAT CONTINUES TO SHEET 4, AND THE NORTHERLY PIPE WILL NOT BE CONSTRUCTED.

SEE SHEET 4 FOR CONTINUATION OF DRAINAGE SWALE TO PROPOSED DESILTING BASIN

SEE SHEET 3 FOR CONTINUATION OF DRAINAGE SWALES TO PROPOSED DESILTING BASIN

SEE SHEET 3



OPERATOR

NAME: LEHIGH SOUTHWEST CEMENT COMPANY
 ADDRESS: 24001 STEVENS CREEK BLVD
 CUPERTINO, CA 95014
 TELEPHONE: 408-996-4227
 SHORT LEGAL: SEC 18 T7S R2W MDBM; W 1/4 & SE 1/4 SEC 17 T7S R2W MDBM
 A.P.N.: 351-09-022; 351-10-005, 037, 038
 SITE ADDRESS: 24001 STEVENS CREEK BLVD.
 CUPERTINO, CA 95014

SHEET INDEX

SHEET 1	COVER SHEET / NOTES / DETAILS
SHEET 2	PHASE A
SHEET 3	PHASE B
SHEET 4	PHASE C
SHEET 5	EROSION CONTROL MEASURES (ALL PHASES)
SHEET 6	POST-RECLAMATION PLAN
SHEET 7	PHASE A/B CROSS-SECTIONS
SHEET 8	PHASE C CROSS-SECTIONS
SHEET 9	OVERALL BOUNDARY/EASEMENTS

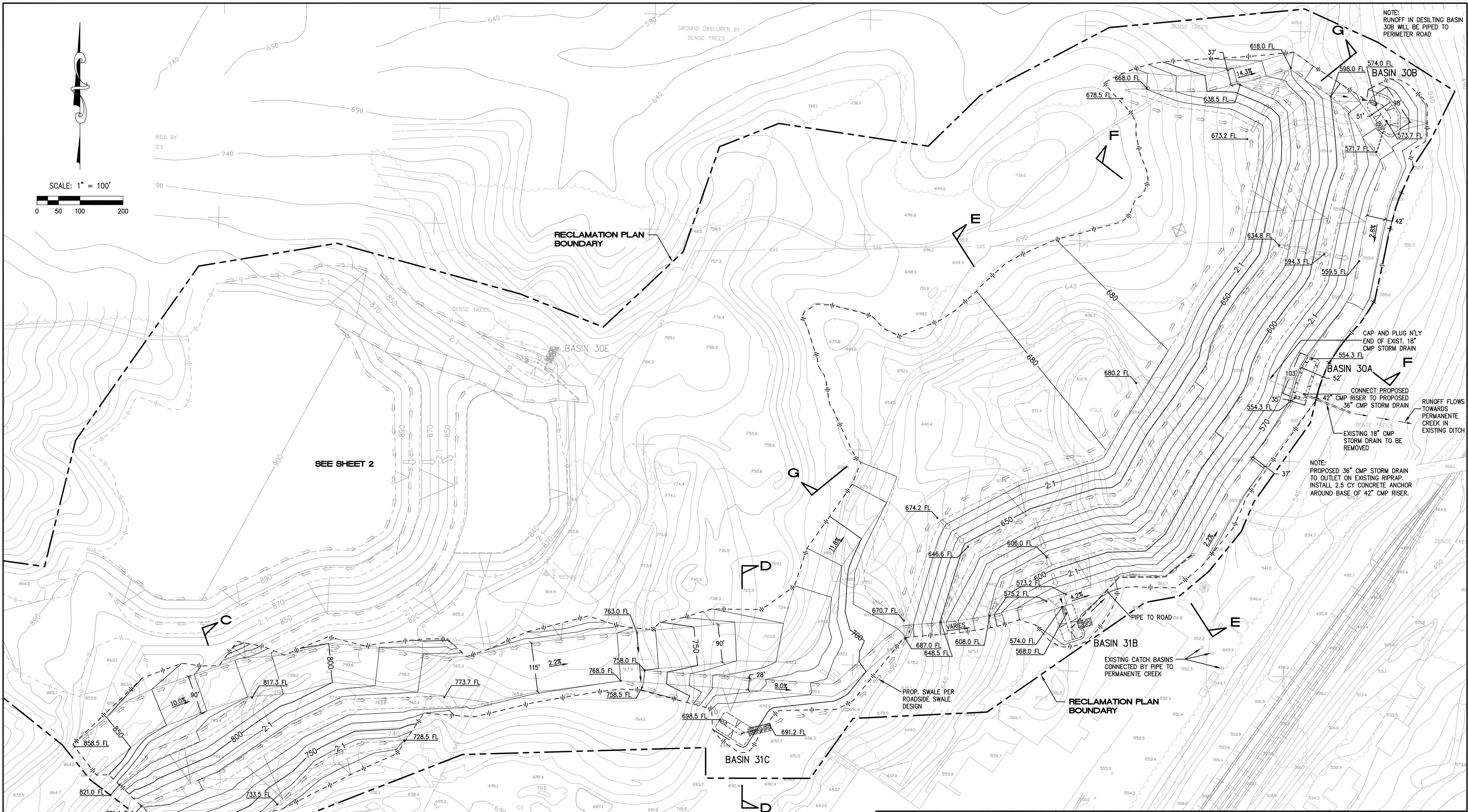
ChangConsultants
 Civil Engineering-Hydrology-Hydraulics-Sedimentation
 P.O. Box 9496 T: 858.692.0760
 Rancho Santa Fe, CA 92067 F: 858.632.1402

**PERMANENTE QUARRY
 EAST MATERIALS STORAGE AREA
 PHASE A**

REVISION 1	DATE		SHEET 2 OF 9
REVISION 2	DATE		
REVISION 3	DATE	CO. FILE	

FOR PLAN CHECK ONLY

CHANG CONSULTANTS
858.692.0760



SCALE: 1" = 100'

0 50 100 200

SEE SHEET 2

RECLAMATION PLAN BOUNDARY

BASIN 30E

CAP AND PLUG N'LY END OF EXIST. 18" CMP STORM DRAIN

BASIN 30A

CONNECT PROPOSED 36" CMP RISER TO PROPOSED 36" CMP STORM DRAIN

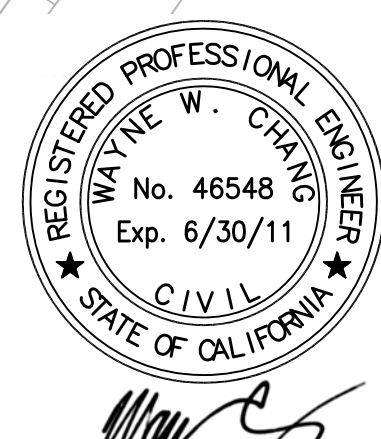
EXISTING 18" CMP STORM DRAIN TO BE REMOVED

NOTE: PROPOSED 36" CMP STORM DRAIN TO OUTLET ON EXISTING RIPRAP. INSTALL 2.5 CY CONCRETE ANCHOR AROUND BASE OF 42" CMP RISER.

FOR PLAN CHECK ONLY

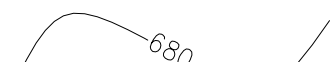




NOTE: RUNOFF IN DESILTING BASIN 30B WILL BE PIPED TO PERIMETER ROAD

CHANG CONSULTANTS
858.692.0760



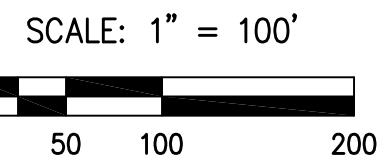
OPERATOR		SHEET INDEX		ChangConsultants Civil Engineering-Hydrology-Hydraulics-Sedimentation P.O. Box 9496 T: 858.692.0760 Rancho Santa Fe, CA 92067 F: 858.632.1402	
NAME: LEHIGH SOUTHWEST CEMENT COMPANY ADDRESS: 24001 STEVENS CREEK BLVD CUPERTINO, CA 95014 TELEPHONE: 408-996-4227 SHORT LEGAL: SEC 18 T7S R2W MDBM; W 1/4 & SE 1/4 SEC 17 T7S R2W MDBM A.P.N.: 351-09-022; 351-10-005, 037, 038 SITE ADDRESS: 24001 STEVENS CREEK BLVD. CUPERTINO, CA 95014		SHEET 1 COVER SHEET / NOTES / DETAILS SHEET 2 PHASE A SHEET 3 PHASE B SHEET 4 PHASE C SHEET 5 EROSION CONTROL MEASURES (ALL PHASES) SHEET 6 POST-RECLAMATION PLAN SHEET 7 PHASE A/B CROSS-SECTIONS SHEET 8 PHASE C CROSS-SECTIONS SHEET 9 OVERALL BOUNDARY/EASEMENTS			
REVISION 1	DATE			SHEET 3	
REVISION 2	DATE			OF 9	
REVISION 3	DATE	CO. FILE			

EROSION CONTROL LEGEND

-  PROPOSED CONTOUR AND ELEVATION LABEL
-  EXISTING CONTOUR AND ELEVATION LABEL
-  PERIMETER SILT FENCING PER DETAIL ON SHEET 5
-  HYDROSEED / MULCH
-  PROPOSED RIPRAP PAD

EROSION CONTROL NOTES

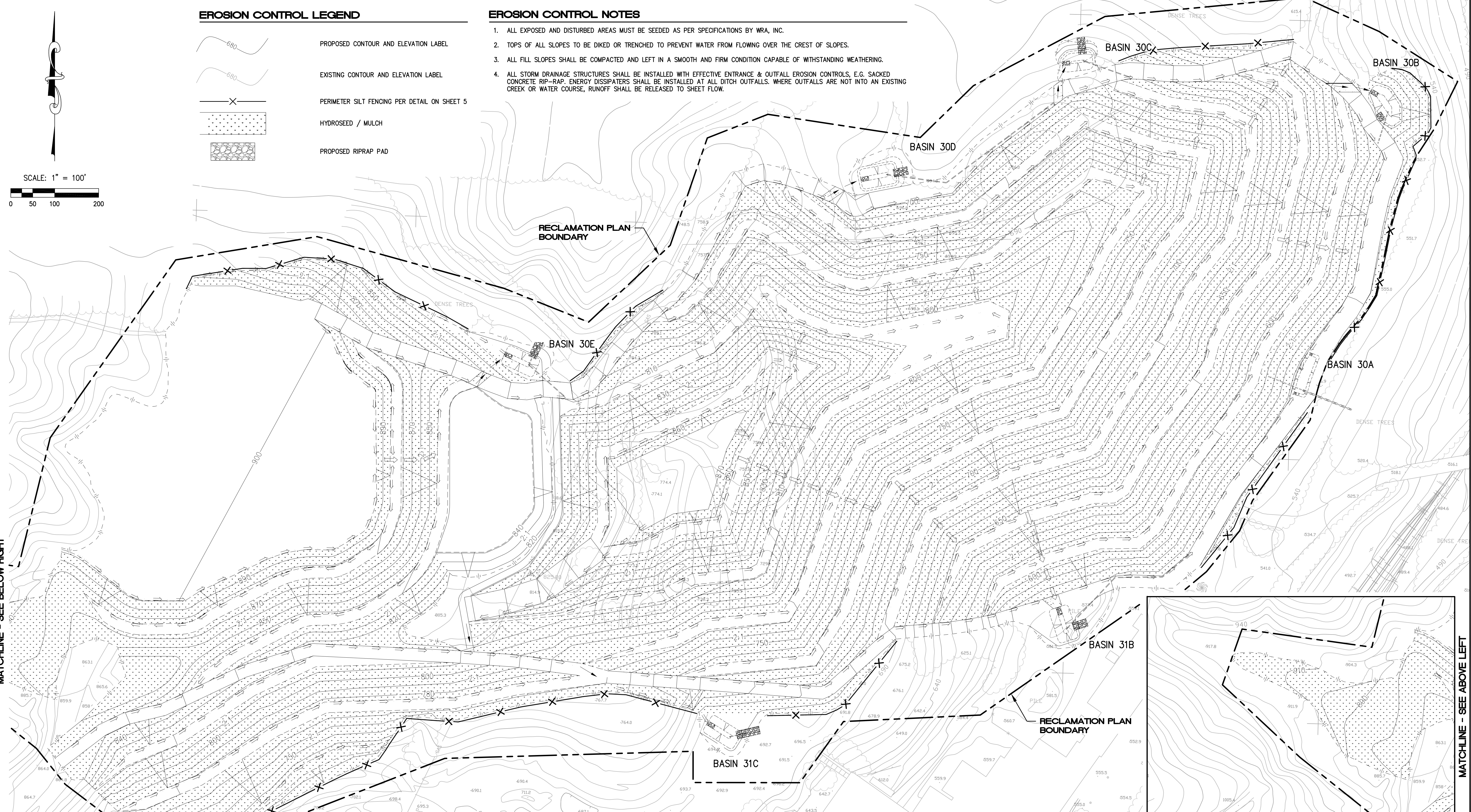
1. ALL EXPOSED AND DISTURBED AREAS MUST BE SEEDED AS PER SPECIFICATIONS BY WRA, INC.
2. TOPS OF ALL SLOPES TO BE DIKED OR TRENCHED TO PREVENT WATER FROM FLOWING OVER THE CREST OF SLOPES.
3. ALL FILL SLOPES SHALL BE COMPACTED AND LEFT IN A SMOOTH AND FIRM CONDITION CAPABLE OF WITHSTANDING WEATHERING.
4. ALL STORM DRAINAGE STRUCTURES SHALL BE INSTALLED WITH EFFECTIVE ENTRANCE & OUTFALL EROSION CONTROLS, E.G. SACKED CONCRETE RIP-RAP. ENERGY DISSIPATORS SHALL BE INSTALLED AT ALL DITCH OUTFALLS. WHERE OUTFALLS ARE NOT INTO AN EXISTING CREEK OR WATER COURSE, RUNOFF SHALL BE RELEASED TO SHEET FLOW.



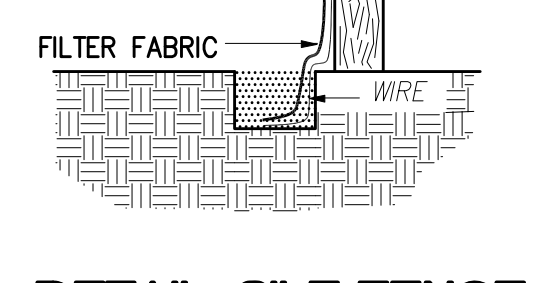
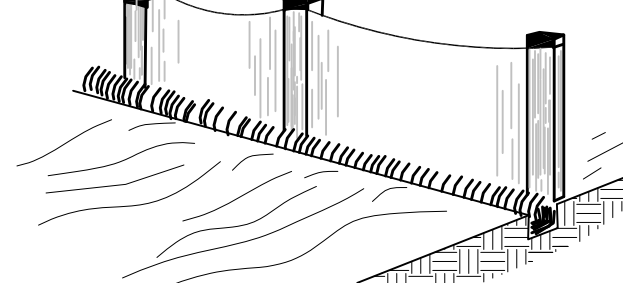
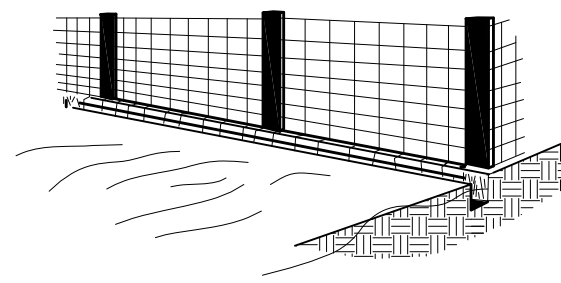
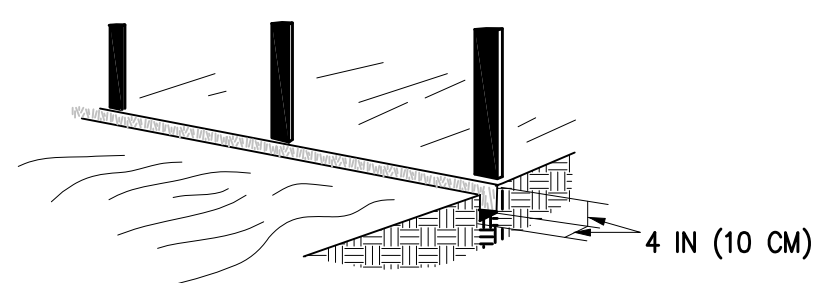
MATCHLINE - SEE BELOW RIGHT

FOR PLAN CHECK ONLY

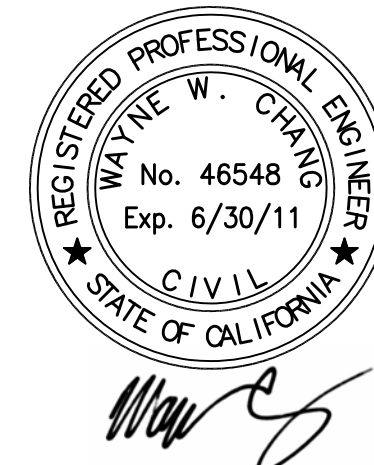
MATCHLINE - SEE ABOVE LEFT




1. SET POSTS AND EXCAVATE A 4 BY 4 IN (10 BY 10 CM) TRENCH UPSLOPE FROM AND ALONG THE LINE OF POSTS.
2. STAPLE FABRIC FENCING TO THE POSTS.
3. ATTACH THE FILTER FABRIC TO THE WIRE FENCE AND EXTEND IT INTO THE TRENCH.
4. BACKFILL AND COMPACT THE EXCAVATED SOIL.

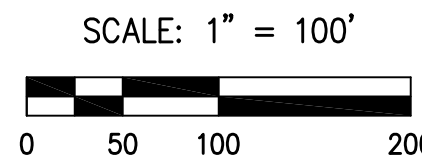
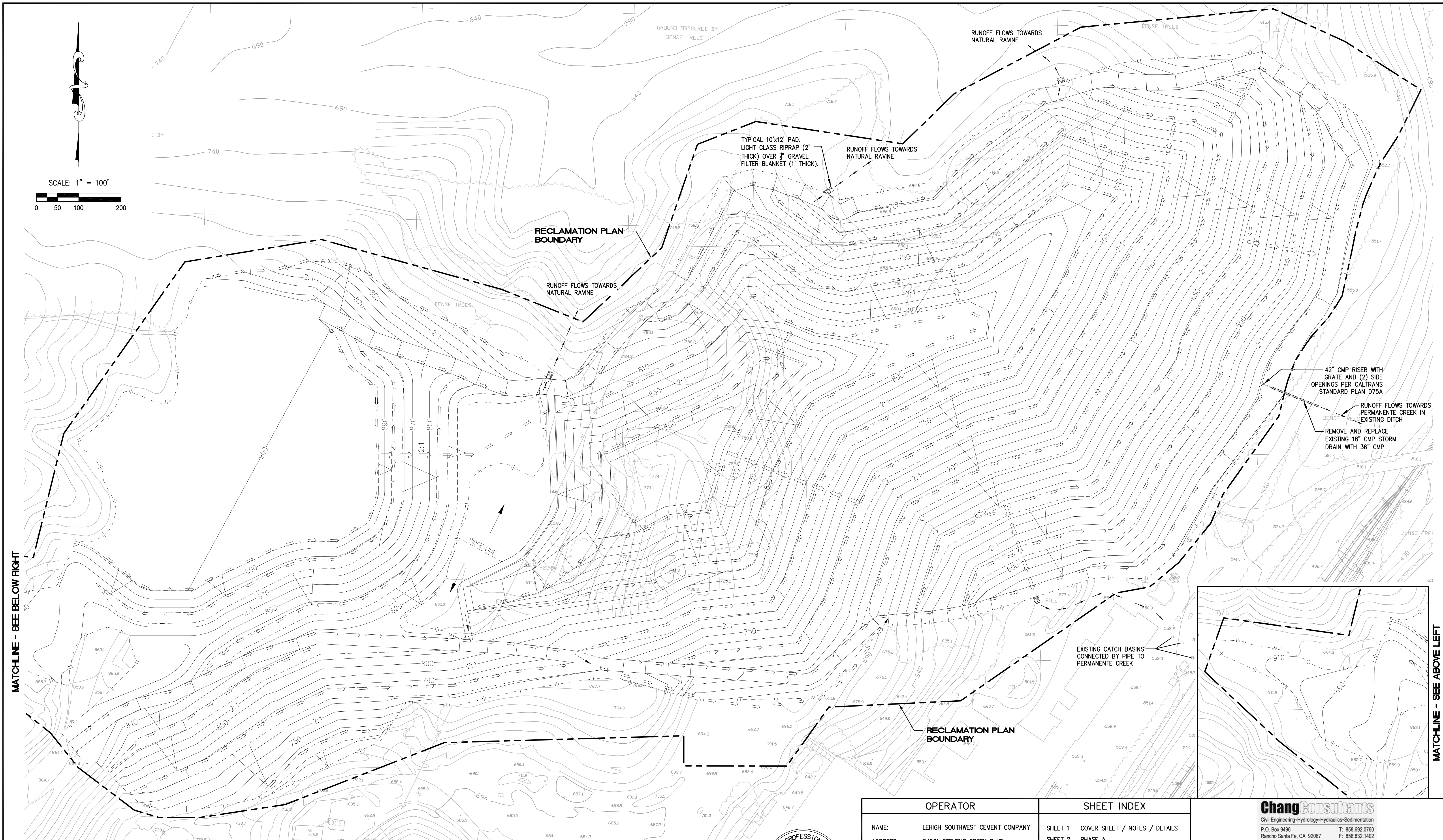


DETAIL: SILT FENCE
NOT TO SCALE



OPERATOR		SHEET INDEX		 Civil Engineering-Hydrology-Hydraulics-Sedimentation P.O. Box 9496 T: 858.692.0760 Rancho Santa Fe, CA 92067 F: 858.632.1402	
NAME: LEHIGH SOUTHWEST CEMENT COMPANY ADDRESS: 24001 STEVENS CREEK BLVD CUPERTINO, CA 95014 TELEPHONE: 408-996-4227 SHORT LEGAL: SEC 18 T7S R2W MDBM; W 1/4 & SE 1/4 SEC 17 T7S R2W MDBM A.P.N.: 351-09-022; 351-10-005, 037, 038 SITE ADDRESS: 24001 STEVENS CREEK BLVD. CUPERTINO, CA 95014		SHEET 1 COVER SHEET / NOTES / DETAILS SHEET 2 PHASE A SHEET 3 PHASE B SHEET 4 PHASE C SHEET 5 EROSION CONTROL MEASURES (ALL PHASES) SHEET 6 POST-RECLAMATION PLAN SHEET 7 PHASE A/B CROSS-SECTIONS SHEET 8 PHASE C CROSS-SECTIONS SHEET 9 OVERALL BOUNDARY/EASEMENTS			
REVISION 1 DATE REVISION 2 DATE REVISION 3 DATE		CO. FILE		SHEET 5 OF 9 CHANG CONSULTANTS 858.692.0760	

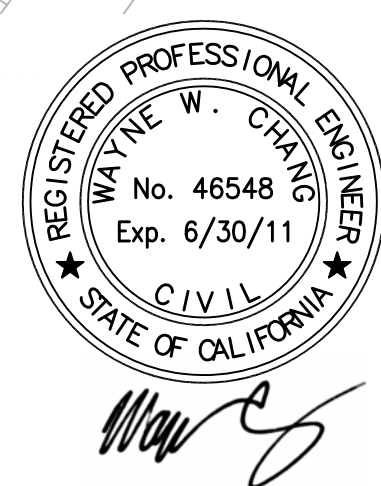
**PERMANENTE QUARRY
EAST MATERIALS STORAGE AREA
EROSION CONTROL MEASURES
(ALL PHASES)**



MATCHLINE - SEE BELOW RIGHT

FOR PLAN CHECK ONLY

MATCHLINE - SEE ABOVE LEFT



OPERATOR	
NAME:	LEHIGH SOUTHWEST CEMENT COMPANY
ADDRESS:	24001 STEVENS CREEK BLVD CUPERTINO, CA 95014
TELEPHONE:	408-996-4227
SHORT LEGAL:	SEC 18 T7S R2W MDBM; W 1/4 & SE 1/4 SEC 17 T7S R2W MDBM
A.P.N.:	351-09-022; 351-10-005, 037, 038
SITE ADDRESS:	24001 STEVENS CREEK BLVD. CUPERTINO, CA 95014

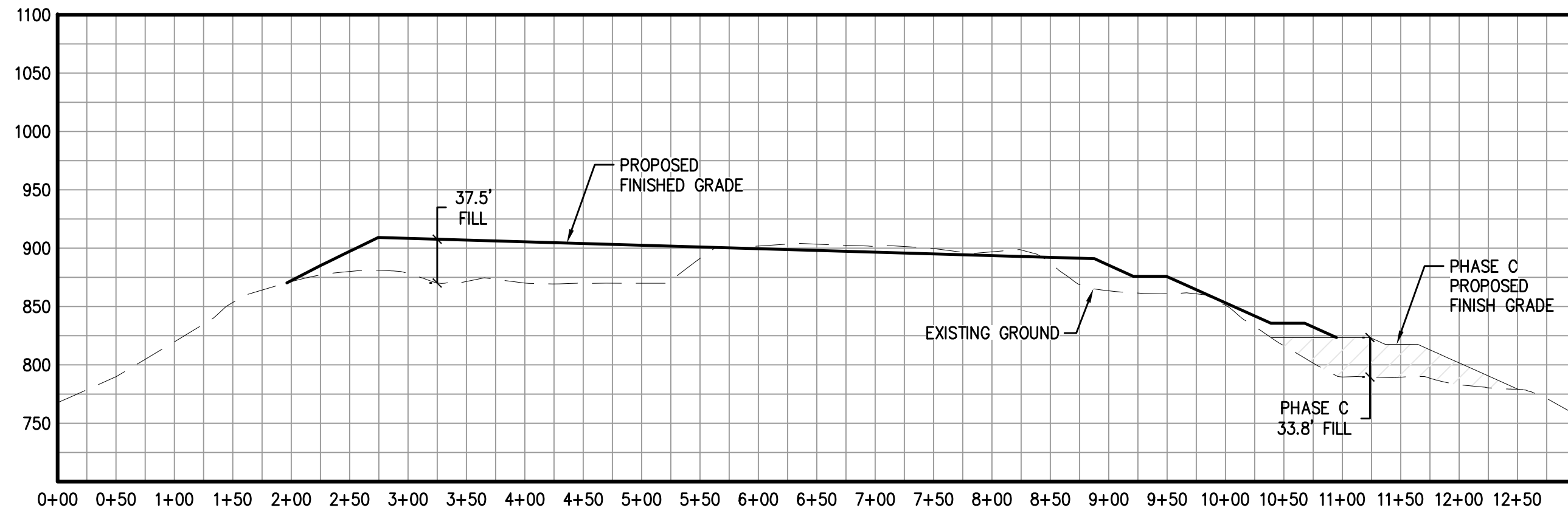
SHEET INDEX	
SHEET 1	COVER SHEET / NOTES / DETAILS
SHEET 2	PHASE A
SHEET 3	PHASE B
SHEET 4	PHASE C
SHEET 5	EROSION CONTROL MEASURES (ALL PHASES)
SHEET 6	POST-RECLAMATION PLAN
SHEET 7	PHASE A/B CROSS-SECTIONS
SHEET 8	PHASE C CROSS-SECTIONS
SHEET 9	OVERALL BOUNDARY/EASEMENTS

ChangConsultants
Civil Engineering-Hydrology-Hydraulics-Sedimentation
P.O. Box 9496 T: 858.692.0760
Rancho Santa Fe, CA 92067 F: 858.832.1402

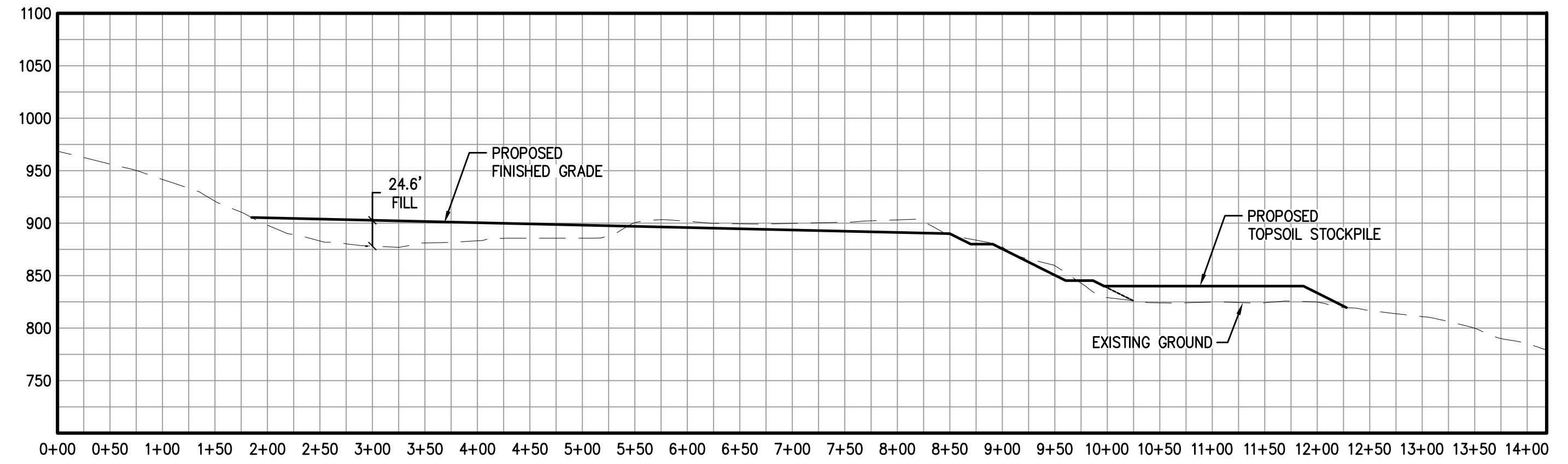
**PERMANENTE QUARRY
EAST MATERIALS STORAGE AREA
POST-RECLAMATION PLAN**

REVISION 1	DATE		SHEET
REVISION 2	DATE		6
REVISION 3	DATE	CO. FILE	OF
			9

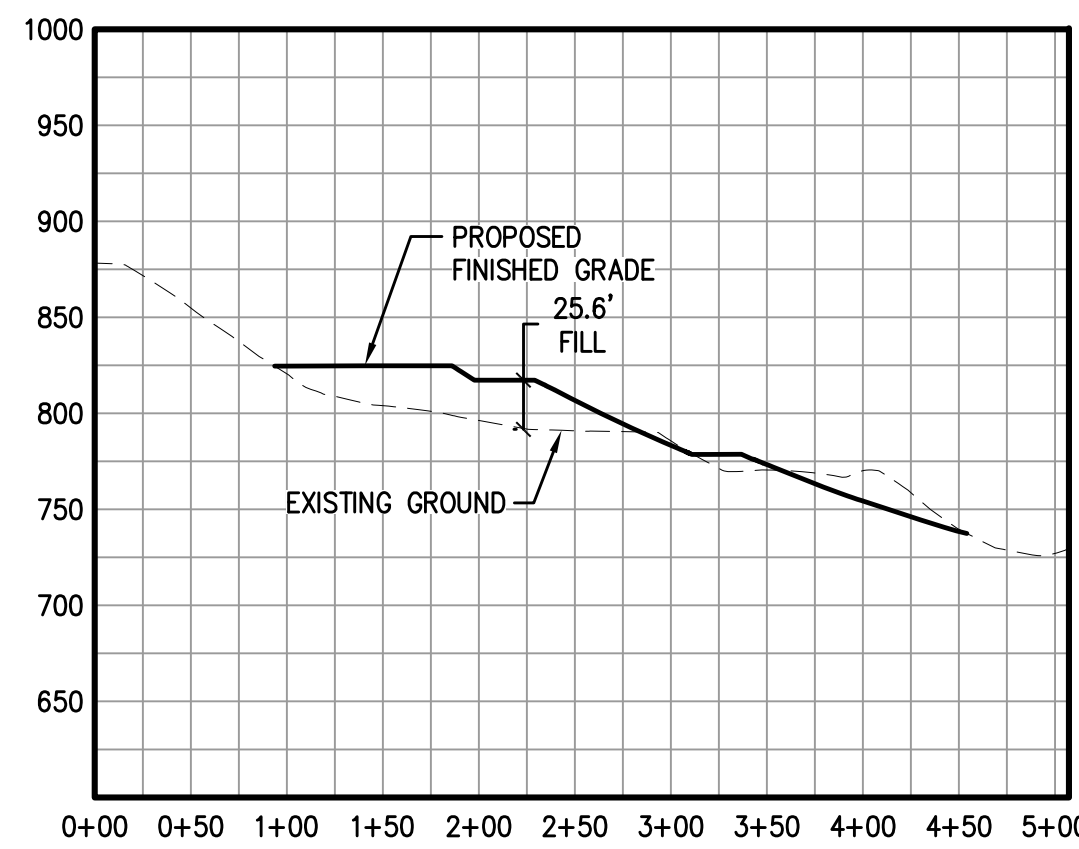
CHANG CONSULTANTS
858.692.0760



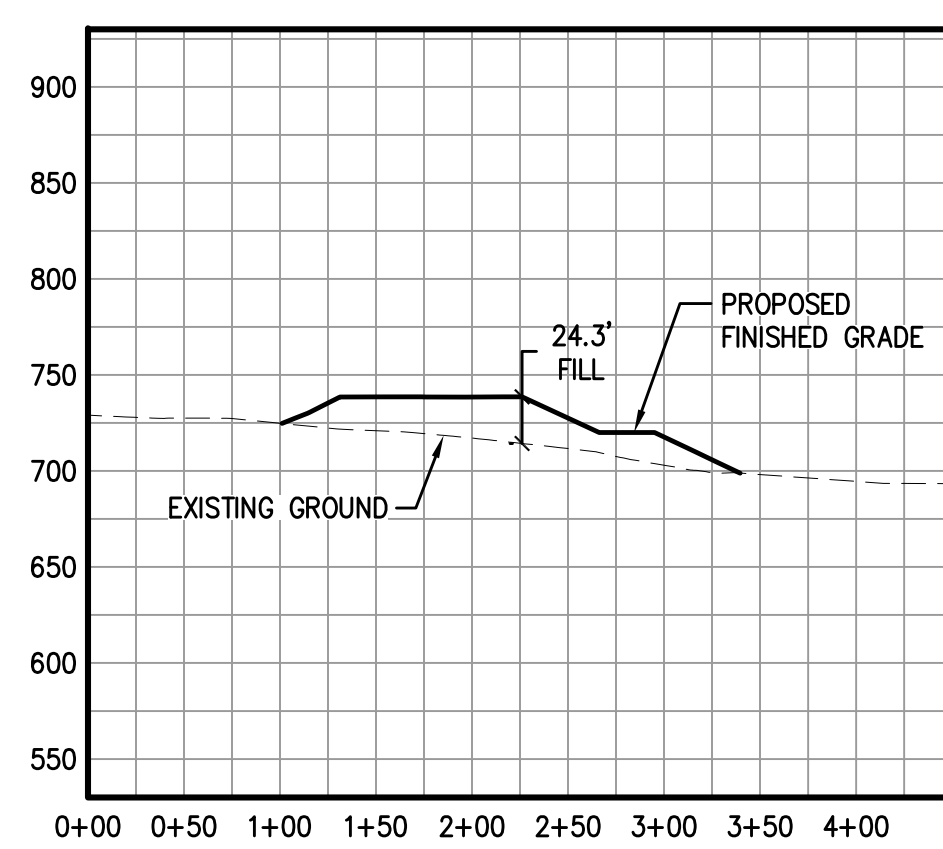
SECTION A-A
SCALE: HORIZ. 1"=100' VERT. 1"=100'



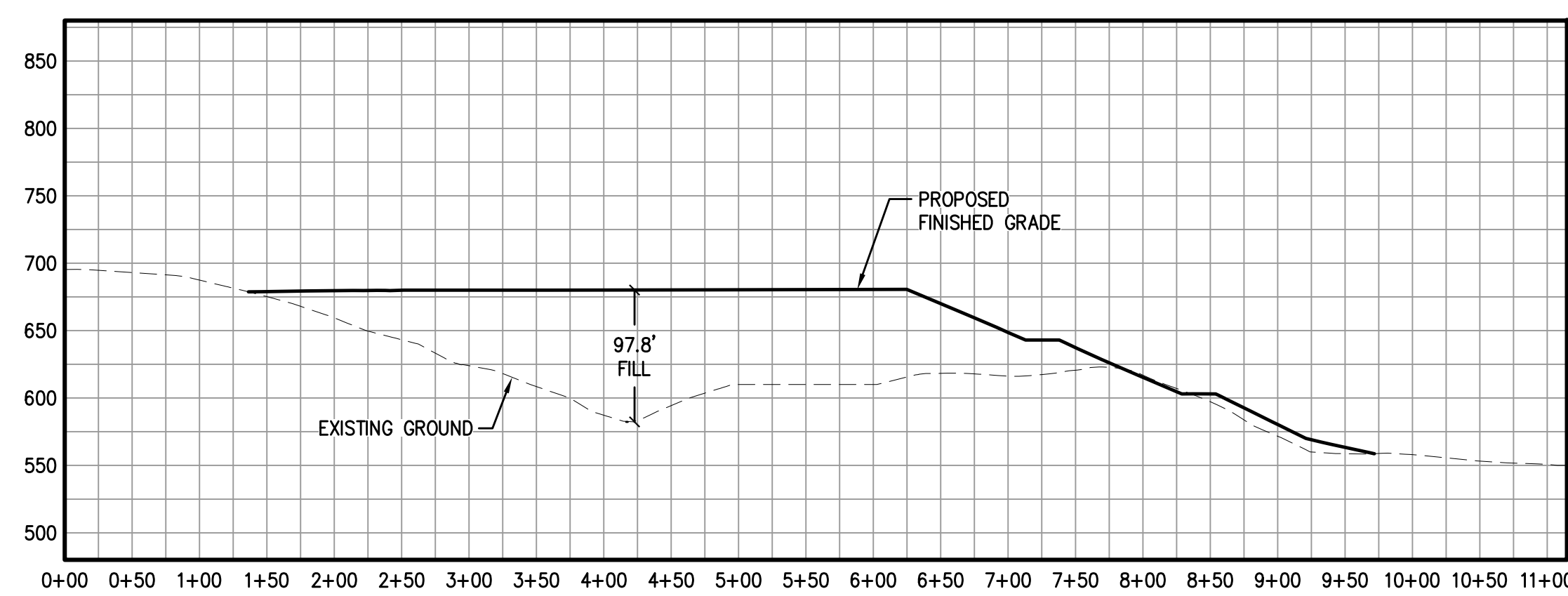
SECTION B-B
SCALE: HORIZ. 1"=100' VERT. 1"=100'



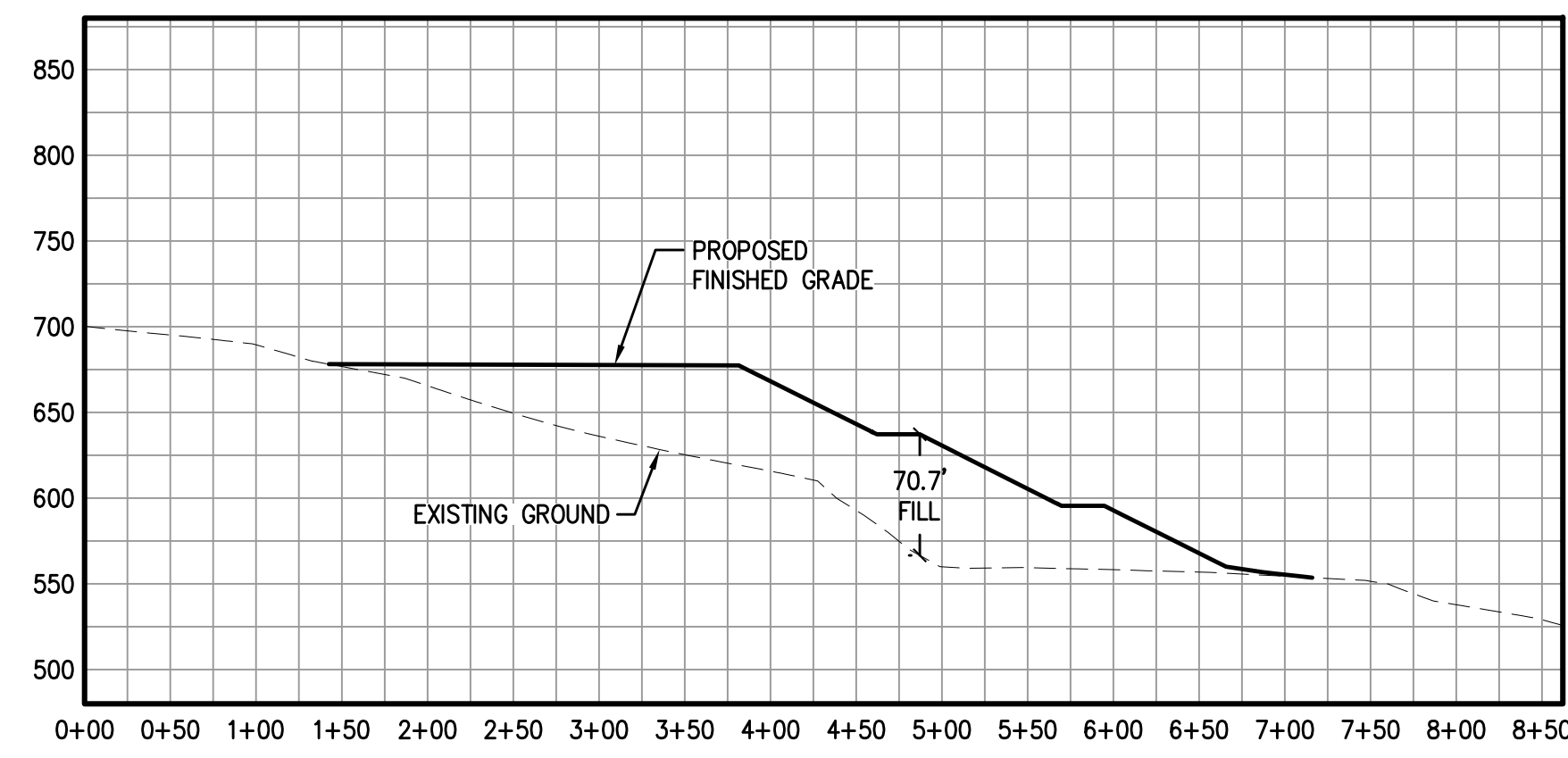
SECTION C-C
SCALE: HORIZ. 1"=100' VERT. 1"=100'



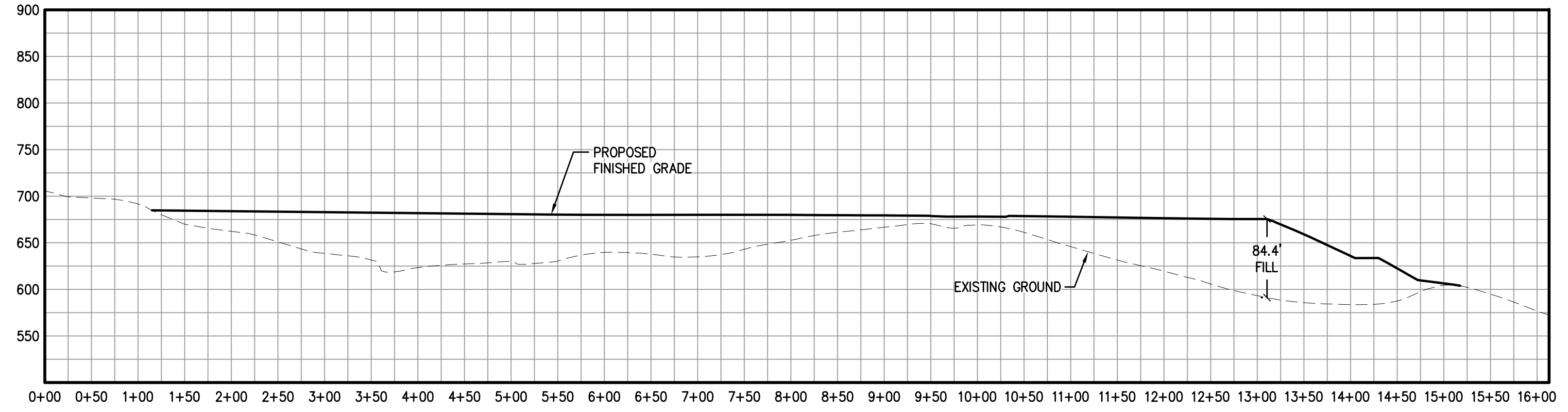
SECTION D-D
SCALE: HORIZ. 1"=100' VERT. 1"=100'



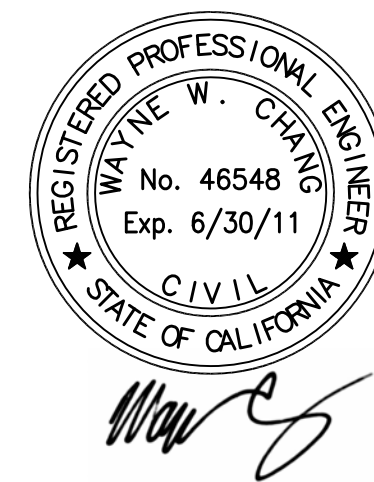
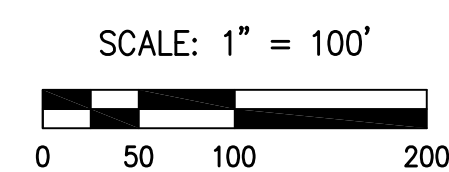
SECTION E-E
SCALE: HORIZ. 1"=100' VERT. 1"=100'



SECTION F-F
SCALE: HORIZ. 1"=100' VERT. 1"=100'



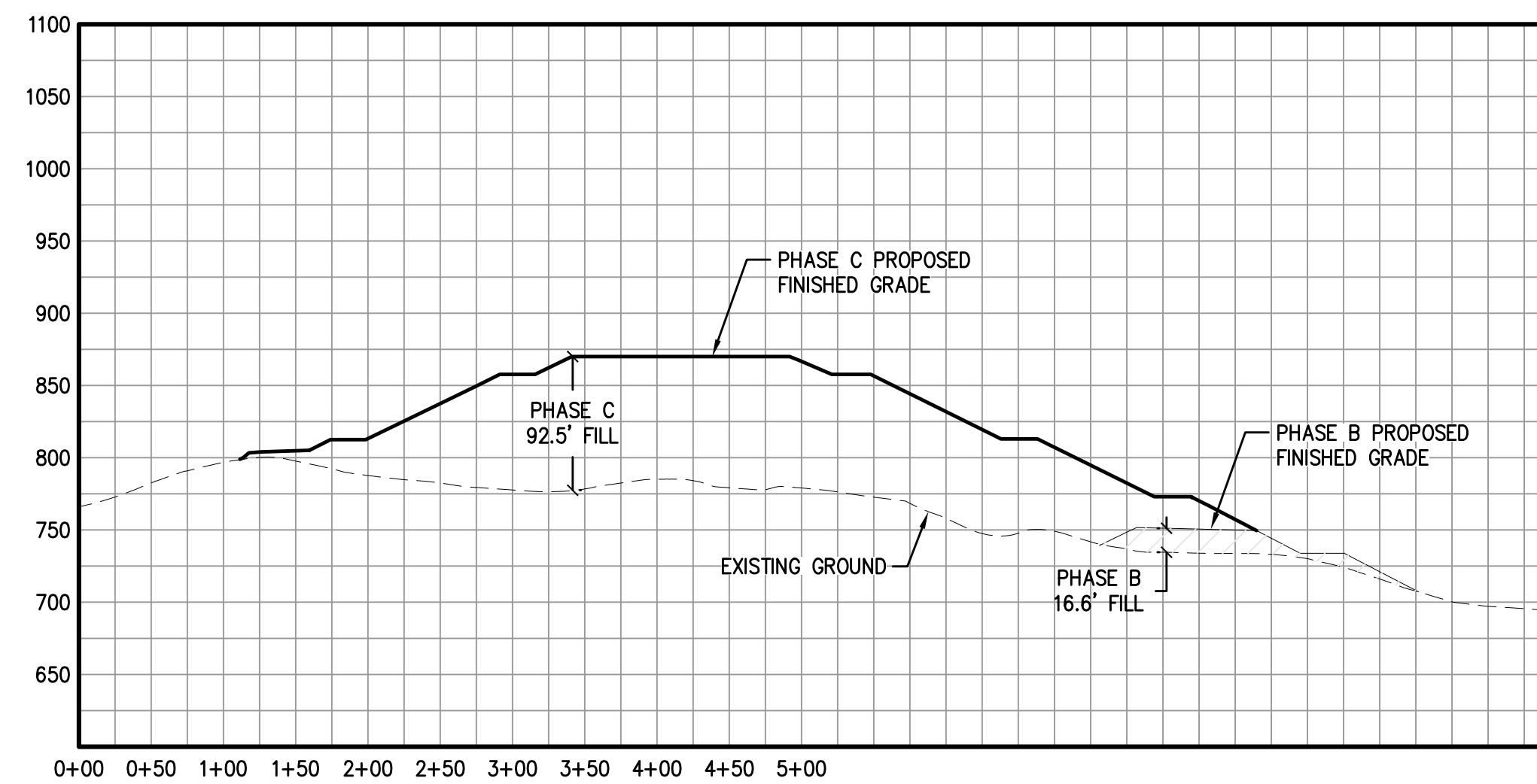
SECTION G-G
SCALE: HORIZ. 1"=100' VERT. 1"=100'



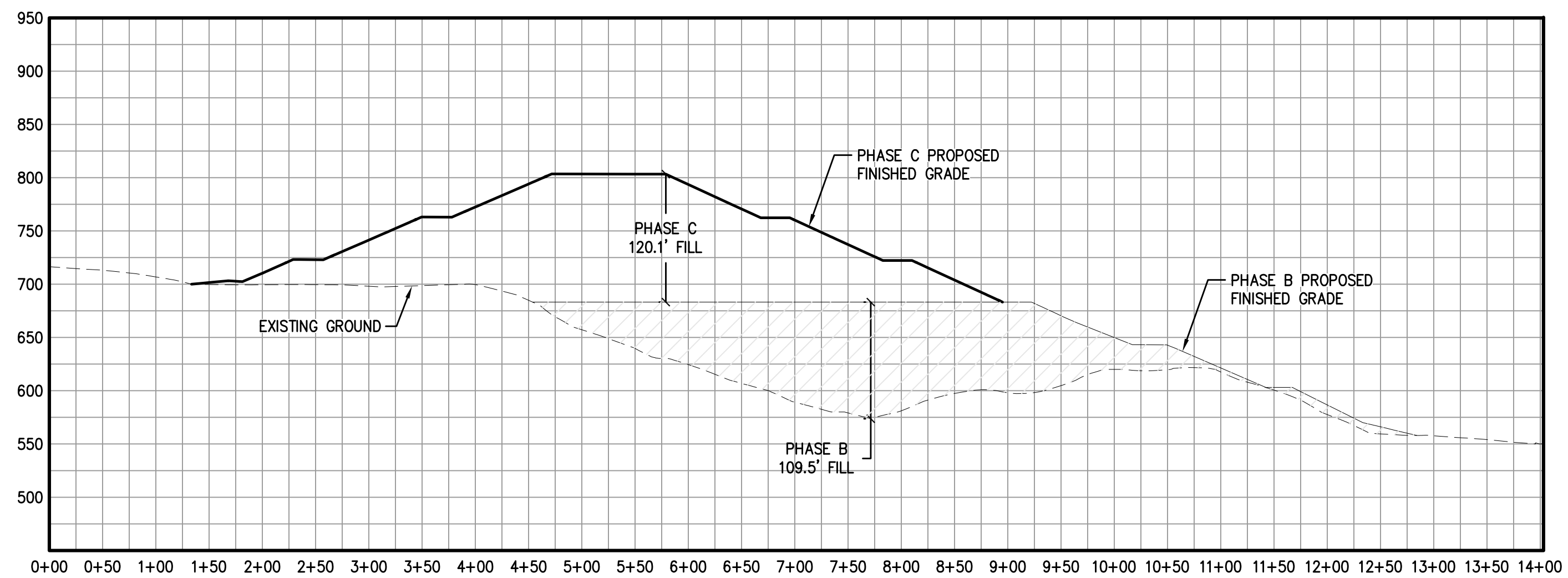
OPERATOR		SHEET INDEX		ChangConsultants Civil Engineering-Hydrology-Hydraulics-Sedimentation P.O. Box 9496 T: 858.692.0760 Rancho Santa Fe, CA 92067 F: 858.632.1402	
NAME:	LEHIGH SOUTHWEST CEMENT COMPANY	SHEET 1	COVER SHEET / NOTES / DETAILS	PERMANENTE QUARRY EAST MATERIALS STORAGE AREA PHASE A/B CROSS-SECTIONS	
ADDRESS:	24001 STEVENS CREEK BLVD CUPERTINO, CA 95014	SHEET 2	PHASE A		
TELEPHONE:	408-996-4227	SHEET 3	PHASE B		
SHORT LEGAL:	SEC 18 T7S R2W MDBM; W 1/4 & SE 1/4 SEC 17 T7S R2W MDBM	SHEET 4	PHASE C		
A.P.N.:	351-09-022; 351-10-005, 037, 038	SHEET 5	EROSION CONTROL MEASURES (ALL PHASES)		
SITE ADDRESS:	24001 STEVENS CREEK BLVD. CUPERTINO, CA 95014	SHEET 6	POST-RECLAMATION PLAN		
		SHEET 7	PHASE A/B CROSS-SECTIONS		
		SHEET 8	PHASE C CROSS-SECTIONS		
		SHEET 9	OVERALL BOUNDARY/EASEMENTS		
REVISION 1	DATE			SHEET	7
REVISION 2	DATE			OF	9
REVISION 3	DATE	CO. FILE			

FOR PLAN CHECK ONLY

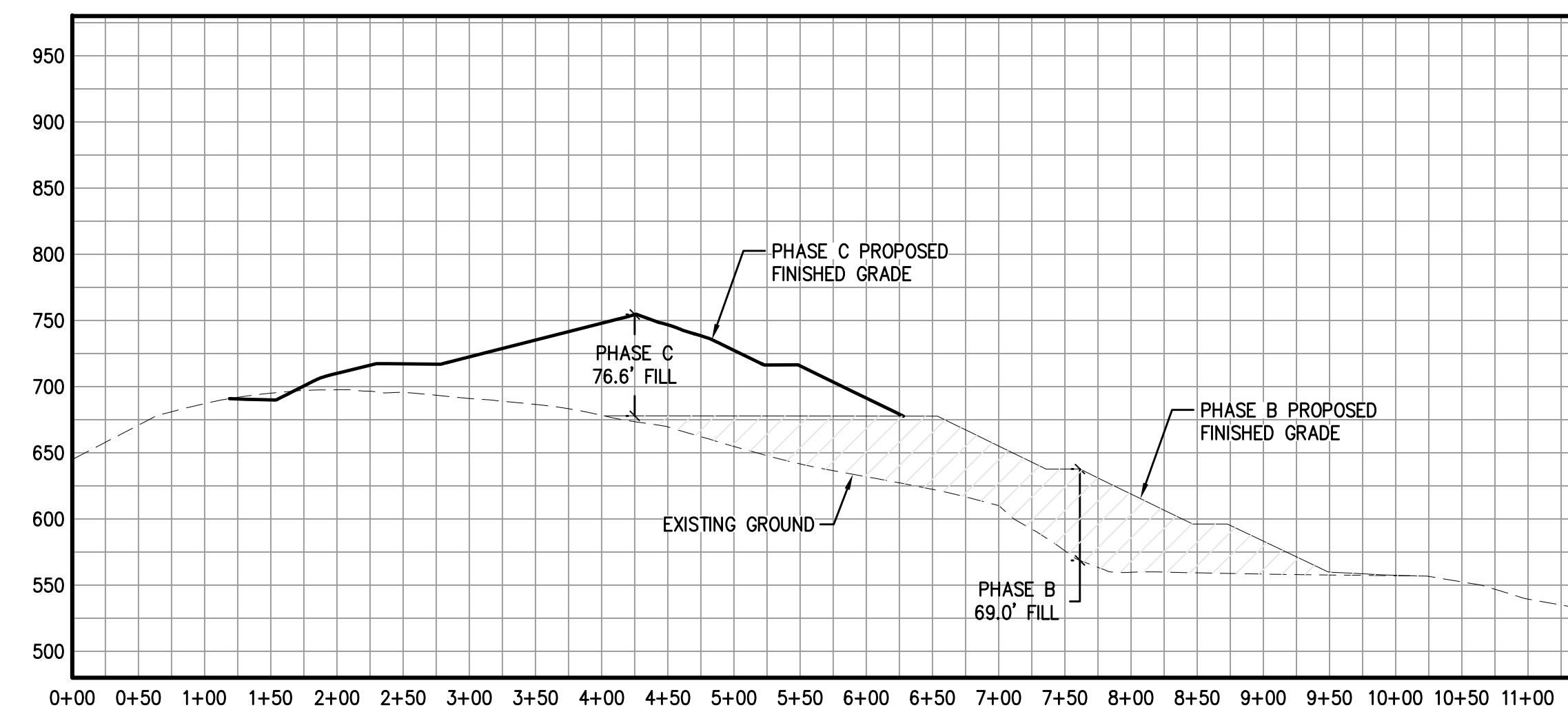
CHANG CONSULTANTS
858.692.0760



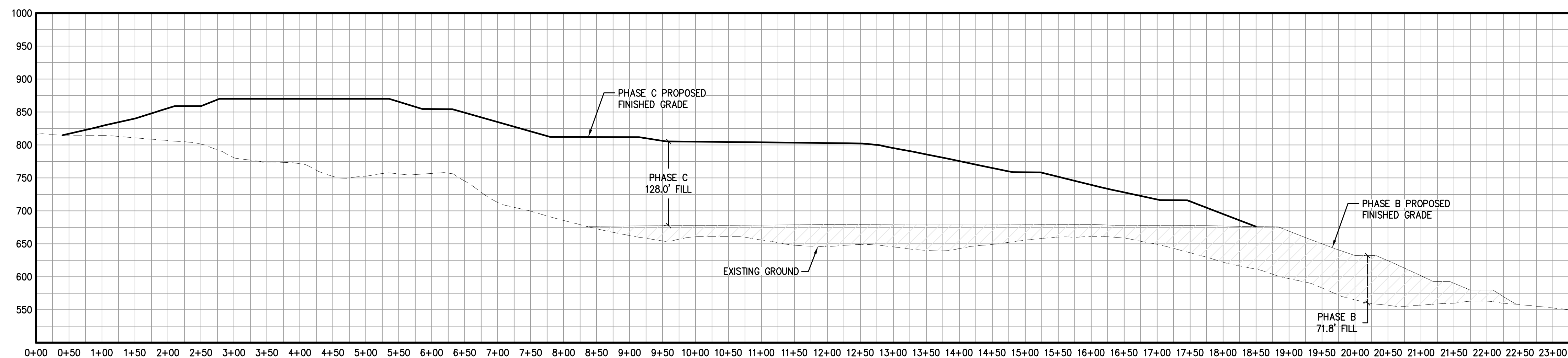
SECTION H-H
SCALE: HORIZ. 1"=100' VERT. 1"=100'



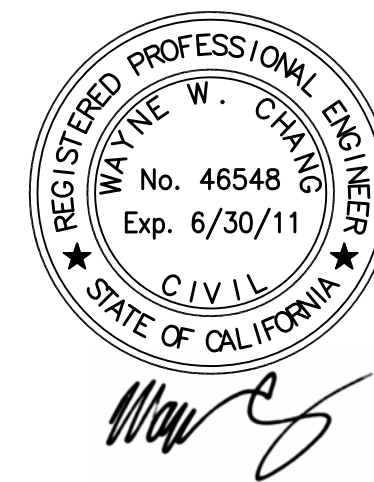
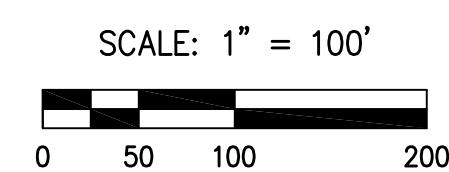
SECTION J-J
SCALE: HORIZ. 1"=100' VERT. 1"=100'



SECTION K-K
SCALE: HORIZ. 1"=100' VERT. 1"=100'



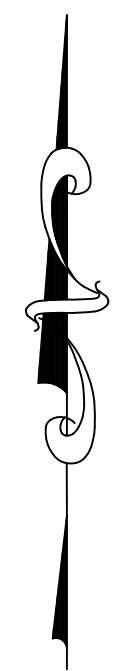
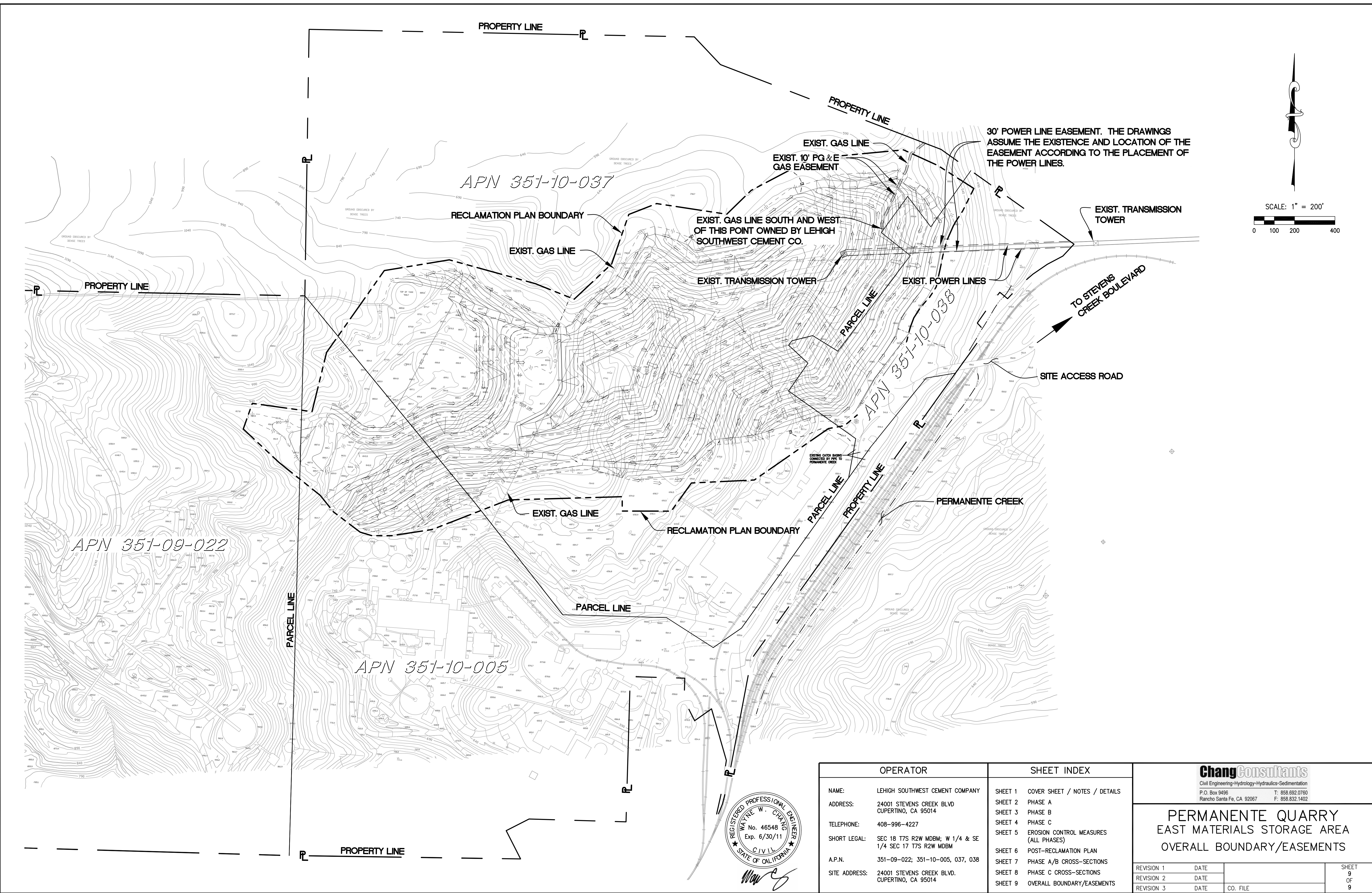
SECTION L-L
SCALE: HORIZ. 1"=100' VERT. 1"=100'



OPERATOR		SHEET INDEX		ChangConsultants Civil Engineering-Hydrology-Hydraulics-Sedimentation P.O. Box 9496 T: 858.692.0760 Rancho Santa Fe, CA 92067 F: 858.632.1402	
NAME:	LEHIGH SOUTHWEST CEMENT COMPANY	SHEET 1	COVER SHEET / NOTES / DETAILS	PERMANENTE QUARRY EAST MATERIALS STORAGE AREA PHASE C CROSS-SECTIONS	
ADDRESS:	24001 STEVENS CREEK BLVD CUPERTINO, CA 95014	SHEET 2	PHASE A		
TELEPHONE:	408-996-4227	SHEET 3	PHASE B		
SHORT LEGAL:	SEC 18 T7S R2W MDBM; W 1/4 & SE 1/4 SEC 17 T7S R2W MDBM	SHEET 4	PHASE C		
A.P.N.:	351-09-022; 351-10-005, 037, 038	SHEET 5	EROSION CONTROL MEASURES (ALL PHASES)		
SITE ADDRESS:	24001 STEVENS CREEK BLVD. CUPERTINO, CA 95014	SHEET 6	POST-RECLAMATION PLAN		
		SHEET 7	PHASE A/B CROSS-SECTIONS		
		SHEET 8	PHASE C CROSS-SECTIONS		
		SHEET 9	OVERALL BOUNDARY/EASEMENTS		
REVISION 1	DATE			SHEET	8
REVISION 2	DATE			OF	9
REVISION 3	DATE	CO. FILE			

FOR PLAN CHECK ONLY

CHANG CONSULTANTS
858.692.0760



SCALE: 1" = 200'
 0 100 200 400

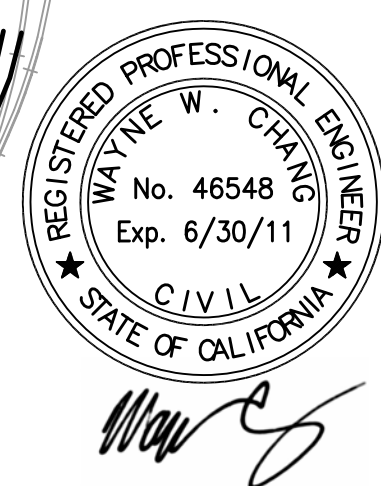
OPERATOR		SHEET INDEX	
NAME:	LEHIGH SOUTHWEST CEMENT COMPANY	SHEET 1	COVER SHEET / NOTES / DETAILS
ADDRESS:	24001 STEVENS CREEK BLVD CUPERTINO, CA 95014	SHEET 2	PHASE A
TELEPHONE:	408-996-4227	SHEET 3	PHASE B
SHORT LEGAL:	SEC 18 T7S R2W MDBM; W 1/4 & SE 1/4 SEC 17 T7S R2W MDBM	SHEET 4	PHASE C
A.P.N.:	351-09-022; 351-10-005, 037, 038	SHEET 5	EROSION CONTROL MEASURES (ALL PHASES)
SITE ADDRESS:	24001 STEVENS CREEK BLVD. CUPERTINO, CA 95014	SHEET 6	POST-RECLAMATION PLAN
		SHEET 7	PHASE A/B CROSS-SECTIONS
		SHEET 8	PHASE C CROSS-SECTIONS
		SHEET 9	OVERALL BOUNDARY/EASEMENTS

ChangConsultants
 Civil Engineering-Hydrology-Hydraulics-Sedimentation
 P.O. Box 9496 T: 858.692.0760
 Rancho Santa Fe, CA 92067 F: 858.632.1402

**PERMANENTE QUARRY
 EAST MATERIALS STORAGE AREA
 OVERALL BOUNDARY/EASEMENTS**

REVISION 1	DATE		
REVISION 2	DATE		
REVISION 3	DATE	CO. FILE	

SHEET 9 OF 9



FOR PLAN CHECK ONLY
 CHANG CONSULTANTS
 858.692.0760

Attachment A
Legal Description

DESCRIPTION: The land referred to herein is situated in the State of California, County of Santa Clara, Unincorporated Area, and is described as follows:

PARCEL ONE:

ALL THAT PORTION OF SOUTHWEST QUARTER (1/4) OF SECTION 16, TOWNSHIP 7 SOUTH, RANGE 2 WEST OF MOUNT DIABLO BASE AND MERIDIAN.

EXCEPTING THEREFROM ALL THAT PARCELS A AND B OF PARCEL MAP, FILED DECEMBER 10, 1979, IN BOOK 455 OF MAPS PAGE 14, SANTA CLARA COUNTY RECORDS.

ALSO EXCEPTING THEREFROM THAT PORTION DESCRIBED AS PARCEL THIRTEEN AND PARCEL FOURTEEN-AS TO PARCEL H11, AS SHOWN IN A DEED RECORDED AUGUST 10, 1995, INSTRUMENT NO. 12978152, IN BOOK N954 AT PAGE 1142, SANTA CLARA COUNTY RECORDS.

ALSO EXCEPTING THEREFROM THAT PORTION CONVEYED TO THE PERMANENTE CORPORATION, AS SHOWN IN THE DEED, RECORDED APRIL 10, 1942, IN BOOK 1090 OF OFFICIAL RECORDS, AT PAGE 212.

ALSO EXCEPTING THEREFROM THAT PORTION CONVEYED TO KAISER CEMENT & GYPSUM CORPORATION, AS DESCRIBED AS PARCEL I IN THE DEED, RECORDED JANUARY 13, 1977 IN BOOK C534 OF OFFICIAL RECORDS, AT PAGE 737.

FURTHER EXCEPTING THEREFROM ALL THAT PORTION LYING EASTERLY OF THE WESTERLY LINE OF THE PROPERTY DESCRIBED IN THE GRANT DEED TO SOUTHERN PACIFIC COMPANY, RECORDED MARCH 25, 1941, IN BOOK 1029 OF OFFICIAL RECORDS AT PAGE 210.

APN: 351-10-005

PARCEL TWO:

ALL OF PARCELS A AND B OF THE PARCEL MAP, FILED DECEMBER 10 1979, IN BOOK 455 OF MAPS PAGE 14, SANTA CLARA COUNTY RECORDS.

PARCEL THREE:

BEGINNING AT A POINT IN THE SOUTHERLY LINE OF THAT CERTAIN 47.5 ACRE PARCEL OF LAND DECRIBED AS "PARCEL A" AND CONVEYED TO THE TODD-CALIFORNIA SHIPBUILDING CORPORATION BY THE PERMANENTE CORPORATION BY DEED RECORDED APRIL 12, 1941 IN THE OFFICE OF THE COUNTY RECORDER OF THE SANTA CLARA COUNTY, CALIFORNIA IN BOOK 1029 OF OFFICIAL RECORDS, AT PAGE 408 THEREOF; DISTANT THEREON NORTH 88° 44' 20" WEST 156.32 FEET FROM THE MOST SOUTHERLY CORNER OF SAID "PARCEL A".

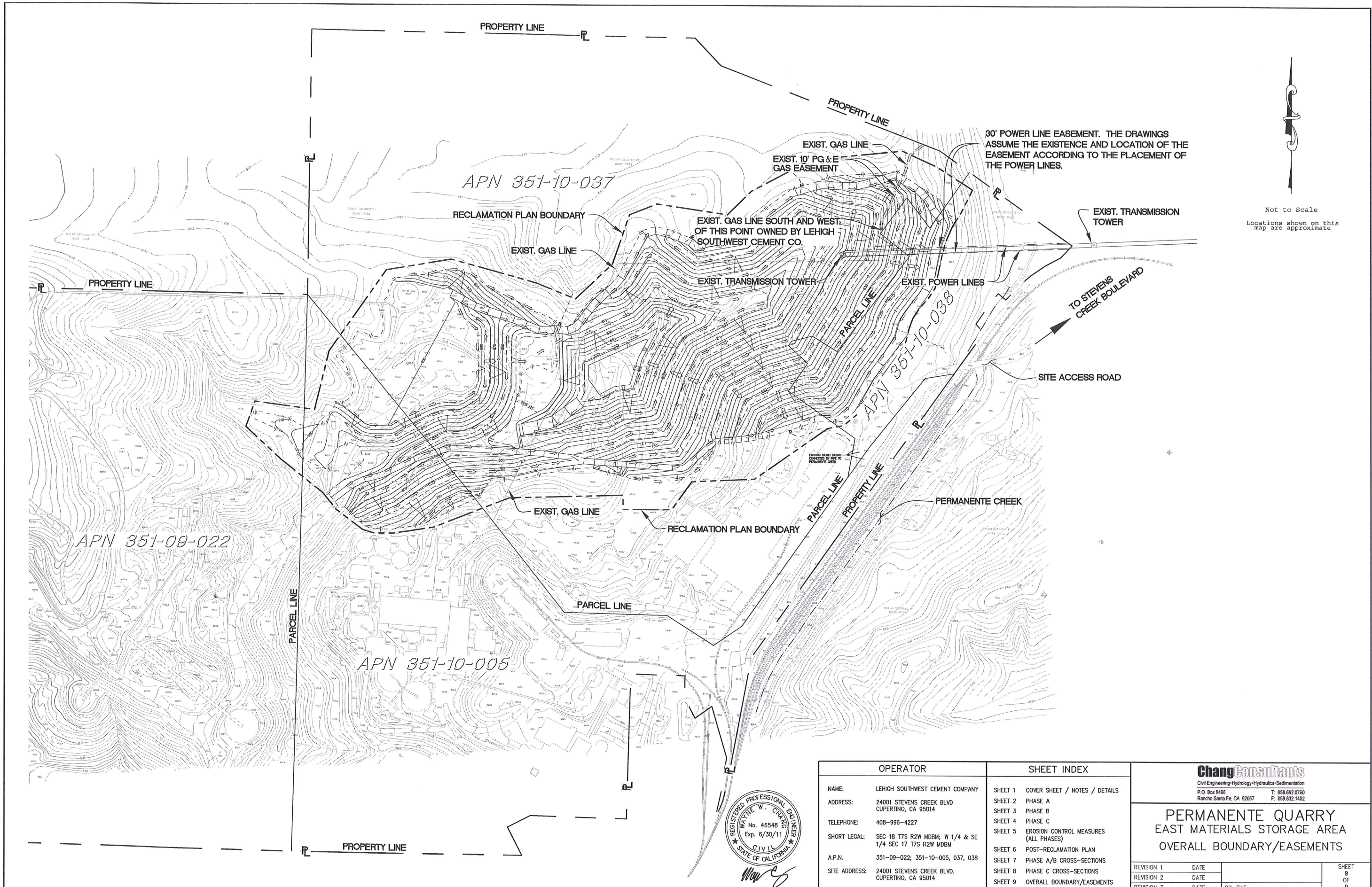
RUNNING THENCE FROM SAID POINT OF BEGINNING SOUTH 35° 09' 32" WEST A DISTANCE OF 50.00 FEET; THENCE SOUTH 55° 09' 32" WEST A DISTANCE OF 170.00 FEET; THENCE NORTH 57° 37' 38" WEST A DISTANCE OF 274.20 FEET TO A POINT IN THE SOUTHERLY LINE OF SAID "PARCEL A"; THENCE ALONG SAID SOUTHERLY LINE OF "PARCEL A" SOUTH 88° 44' 20" EAST A DISTANCE OF 400.00 FEET, MORE OR LESS, TO SAID POINT OF BEGINNING.


APN: 351-10-037 AND 351-10-038

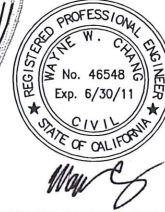
PARCEL FOUR:

LOTS 5, 6, 7 AND 8 AND SOUTHEAST 1/4 OF SECTION 17, TOWNSHIP 7 SOUTH RANGE 2 WEST, MOUNT DIABLO BASE AND MERIDIAN.

APN: 351-09-022




 Not to Scale
 Locations shown on this map are approximate



OPERATOR		SHEET INDEX	
NAME:	LEHIGH SOUTHWEST CEMENT COMPANY	SHEET 1	COVER SHEET / NOTES / DETAILS
ADDRESS:	24001 STEVENS CREEK BLVD CUPERTINO, CA 95014	SHEET 2	PHASE A
TELEPHONE:	408-996-4227	SHEET 3	PHASE B
SHORT LEGAL:	SEC 18 T7S R2W MDBM; W 1/4 & SE 1/4 SEC 17 T7S R2W MDBM	SHEET 4	PHASE C
A.P.N.:	351-09-022; 351-10-005, 037, 038	SHEET 5	EROSION CONTROL MEASURES (ALL PHASES)
SITE ADDRESS:	24001 STEVENS CREEK BLVD. CUPERTINO, CA 95014	SHEET 6	POST-RECLAMATION PLAN
		SHEET 7	PHASE A/B CROSS-SECTIONS
		SHEET 8	PHASE C CROSS-SECTIONS
		SHEET 9	OVERALL BOUNDARY/EASEMENTS

Chang Consultants
 Civil Engineering-Hydrology-Hydraulics-Sedimentation
 P.O. Box 9496 T: 658.692.0760
 Rancho Santa Fe, CA 92067 F: 658.832.1402

**PERMANENTE QUARRY
 EAST MATERIALS STORAGE AREA
 OVERALL BOUNDARY/EASEMENTS**

REVISION 1	DATE	SHEET 9 OF 9
REVISION 2	DATE	
REVISION 3	DATE	

CO. FILE

FOR PLAN CHECK ONLY

Attachment B

Biological Resources Assessment

Biological Resources Assessment Permanente Quarry - East Materials Storage Area

CUPERTINO, SANTA CLARA COUNTY
CALIFORNIA

Prepared For:

Lehigh Southwest Cement Company
24001 Stevens Creek Blvd.
Cupertino CA, 95014-5659

Contact:

Mike Josselyn
josselyn@wra-ca.com

Geoff Smick
smick@wra-ca.com

Date:

April 2009



TABLE OF CONTENTS

1.0	INTRODUCTION	1
1.1	General RPA Area Description.....	1
1.2	General Project Description	1
2.0	REGULATORY BACKGROUND	4
2.1	Sensitive Biological Communities	4
2.2	Special Status Species.....	5
3.0	METHODS	6
3.1	Vegetation Communities	6
3.2	Sensitive Biological Communities and Aquatic Features	7
3.2.1	Wetlands and Waters	7
3.2.2	Riparian Habitat.....	8
3.2.3	Other Sensitive Biological Communities.....	8
3.3	Special Status Species.....	8
3.3.1	Literature Review.....	8
3.3.2	Site Assessment.....	8
3.3.3	Rare plant surveys	9
4.0	RESULTS	9
4.1	Vegetation Communities	9
4.1.1	Non-Sensitive Vegetation Community Types	11
4.1.2	Sensitive Biological Communities.....	13
4.2	Special Status Species.....	14
4.2.1	Plants.....	14
4.2.2	Wildlife	16
4.2.2.1	Species present in the RPA Area	16
4.2.2.2	Species with a high or moderate potential to occur within the RPA Area	19
4.2.2.3	Federally Listed Species Unlikely to occur within the RPA Area	20
5.0	SUMMARY.....	21
5.1	Vegetation Communities	21
5.1.1	Non-Sensitive Vegetation Communities	21
5.1.2	Sensitive Vegetation Communities.....	21
5.2	Special Status Species.....	22
5.2.1	Plants.....	22
5.2.2	Wildlife	22
5.2.2.1	Woodrat	22
5.2.2.2	Avian species	22
5.2.2.3	Amphibians.....	22
5.2.2.4	Bats	22
6.0	RECOMMENDATIONS.....	23
6.1	Woodrat.....	23
6.2	Avian Species.....	23
6.3	Roosting Bats	24

LIST OF TABLES

Table 1. Vegetation Communities and Land Use in the RPA Area..... 11

LIST OF FIGURES

Figure 1. Location Map 2
Figure 2. Proposed EMSA 3
Figure 3. Vegetative communities within the RPA Area 10
Figure 4. Special Status Plant Occurrences within Five Miles of the RPA Area 15
Figure 5. Special Status Wildlife Occurrences within Five Miles of the RPA Area..... 17
Figure 6. Sensitive Occurrences and Communities within the RPA Area..... 18

LIST OF APPENDICES

Appendix A. Potential for Special Status Species to Occur in the RPA Area
Appendix B. Species Observed in the RPA Area
Appendix C. Representative Site Photographs

1.0 INTRODUCTION

In January and February 2009, WRA, Inc. performed an assessment of biological resources on an approximately 89-acre area (Reclamation Plan Amendment Area [RPA Area], Figure 1), which Lehigh Southwest Cement Company (Lehigh) proposes to include in the Reclamation Plan for the Permanente Quarry. The primary feature in the RPA Area is the East Material Storage Area (EMSA), which provides storage for overburden rock excavated during mining operations in other portions of the Quarry. The purpose of the assessment was to gather information necessary to complete a review of biological resources in the RPA Area.

This report describes the results of the site visit, which assessed the RPA Area for the (1) presence of special status species; (2) potential to support special status species; and (3) presence of other sensitive biological resources protected by local, state, and federal laws and regulations.

A biological resources assessment provides general information on the potential presence of sensitive species and habitats. The biological resources assessment is not an official protocol-level survey for listed species that may be required for project approval by local, state, or federal agencies. However, specific findings on the occurrence of any species or the presence of sensitive habitats may require that protocol surveys be conducted. Protocol-level rare plant surveys were conducted prior to the biological assessment in April and June 2008 with results discussed in this report. This assessment is based on information available at the time of the study and on site conditions that were observed on the dates of the site visits.



1.1 General RPA Area Description

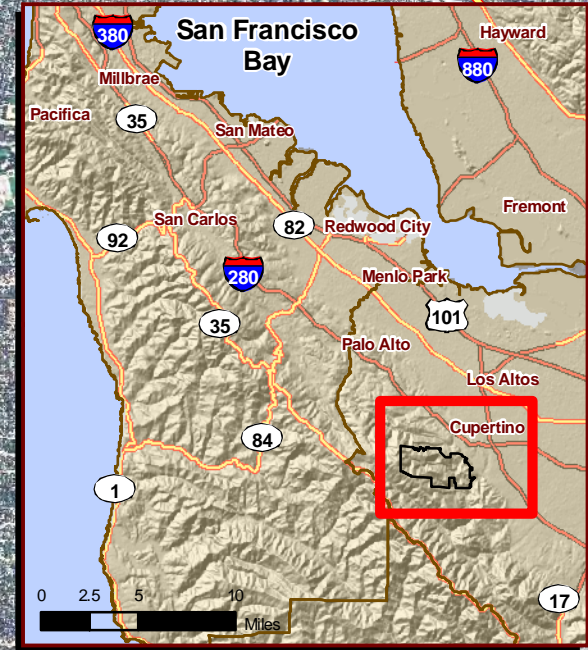
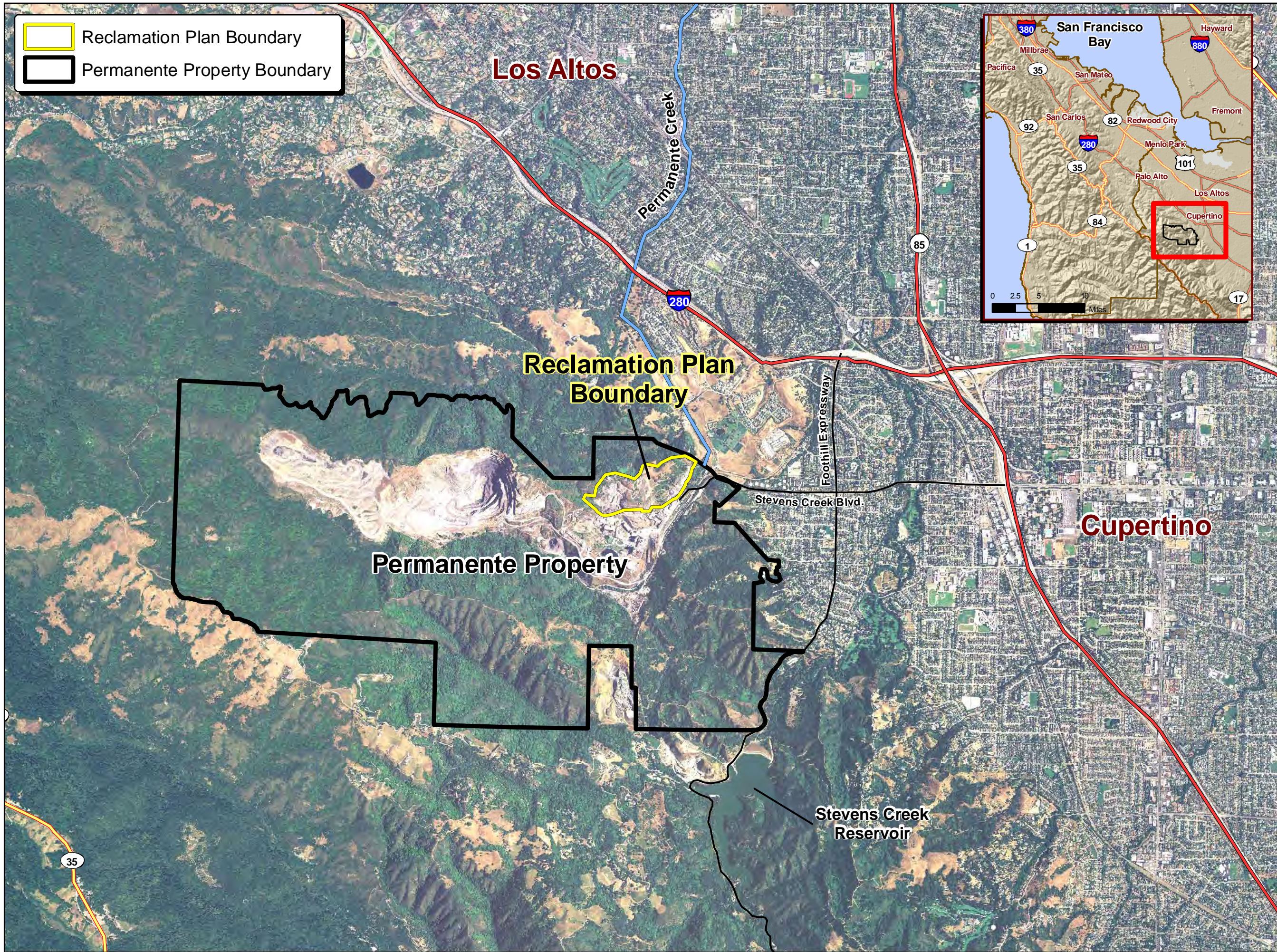
The RPA Area is approximately 89 acres and is located north of Monte Bello Ridge, and due south of Rancho San Antonio County Park, at the west end of Permanente Road, approximately 4 miles west of downtown Cupertino in Santa Clara County. The RPA Area elevation ranges from approximately 525 to over 1000 feet above sea level.

The RPA Area is characterized as a ridge and south-facing slope that is disturbed by past and ongoing quarry operations. A majority of the RPA Area contains piles of mined overburden with areas of mixed scrub, oak woodland, chamise chaparral, ruderal herbaceous grasslands and non-native annual grassland (Table 1). The RPA Area includes the EMSA in addition to a variable buffer zone (0-100 feet) surrounding the EMSA footprint (Figure 2).

1.2 General Project Description

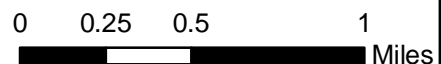
The project is a proposed amendment of the Reclamation Plan for the Quarry to include the EMSA subject to the requirements of the state Surface Mining and Reclamation Act and Santa Clara County surface mining ordinance. Reclamation of the EMSA will occur at elevations from 550 feet to 900 feet above sea level. Upon reclamation, overburden rock will be contoured at 2:1 slopes, interrupted at 40-foot intervals with 25-foot benches for slope stability. Reclamation of the EMSA will include revegetation with native species following the guidance set forth in the Reclamation Standards. Reclamation will occur in phases as overburden rock is received by the EMSA, with progressive revegetation of slopes and benches as the planned landforms are completed.

 Reclamation Plan Boundary
 Permanente Property Boundary



East Materials Storage Area,
 Lehigh Permanente Quarry,
 Santa Clara County,
 California

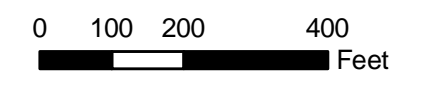
Figure 1.
 Reclamation Plan
 Amendment
 Location Map



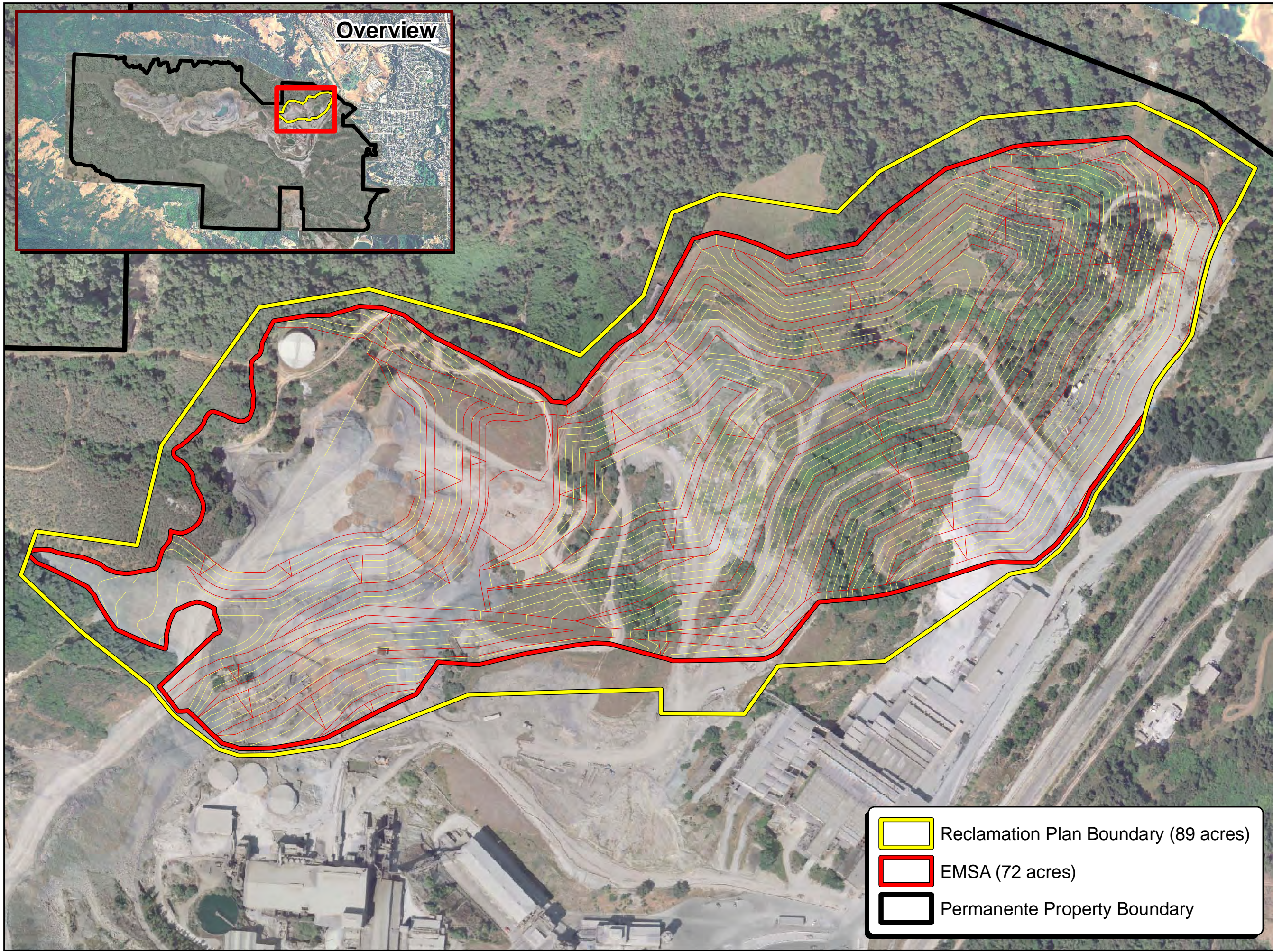
Date: April 2009
 Map By: Michael Rochelle
 Image: 2005 NAIP
 Filepath: I:\Acad2000\16000\16143\gis\
 Arcmap\BA\EMSA\March 09\Location.mxd

East Materials Storage Area,
Lehigh Permanente Quarry,
Santa Clara County,
California

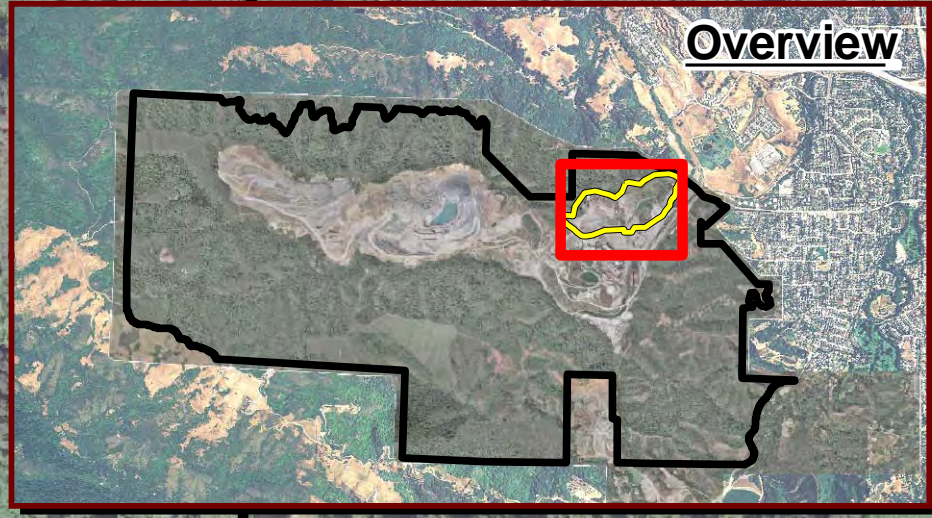
Figure 2.
Proposed Project Areas

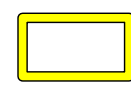
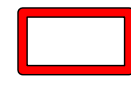



Date: April 2009
Map By: Michael Rochelle
Image Date: April 2007
Filepath: I:\Acad2000\16000\16143\gis\Arcmap\BA\EMSA\March 09\ProjectFootprint.mxd



Overview



-  Reclamation Plan Boundary (89 acres)
-  EMSA (72 acres)
-  Permanente Property Boundary

2.0 REGULATORY BACKGROUND

The following sections explain the regulatory context of the biological resource assessment, including applicable laws and regulations that were applied to the field investigations and analysis of potential project impacts.

2.1 Sensitive Biological Communities

Sensitive biological communities include habitats that fulfill special functions or have special values, such as wetlands, streams, and riparian habitat. These habitats are protected under federal regulations (such as the Clean Water Act), state regulations (such as the Porter-Cologne Act, the California Department of Fish and Game [CDFG] Streambed Alteration Program, and the California Environmental Quality Act [CEQA]), or local ordinances or policies (Special Habitat Management Areas, Habitat Conservation Plans, and General Plan Elements).

Waters of the United States

The U.S. Army Corps of Engineers (Corps) regulates “Waters of the United States” under Section 404 of the Clean Water Act. “Waters of the U.S.” are defined broadly as waters susceptible to use in commerce, including interstate waters and wetlands, all other waters (intrastate waterbodies, including wetlands), and their tributaries (33 CFR 328.3). Potential wetland areas, according to the three criteria used to delineate wetlands stated in the *Corps of Engineers Wetlands Delineation Manual* (Environmental Laboratory 1987), are identified by the presence of (1) hydrophytic vegetation, (2) hydric soils, and (3) wetland hydrology. Areas that are inundated for sufficient duration and depth to exclude growth of hydrophytic vegetation are subject to Section 404 jurisdiction as “other waters” and are often characterized by an ordinary high water mark (OHWM). Other waters, for example, generally include lakes, rivers, and streams. The placement of fill material into “Waters of the U.S.” (including wetlands) generally requires an individual or nationwide permit from the Corps under Section 404 of the Clean Water Act.

Waters of the State

The term “Waters of the State” is defined by the Porter-Cologne Act as “any surface water or groundwater, including saline waters, within the boundaries of the state.” The Regional Water Quality Control Board (RWQCB) protects all waters in its regulatory scope, but has special responsibility for wetlands, riparian areas, and headwaters. These waterbodies have high resource value, are vulnerable to filling, and are not systematically protected by other programs. RWQCB jurisdiction includes “isolated” wetlands and waters that may not be regulated by the Corps under Section 404. “Waters of the State” are regulated by the RWQCB under the State Water Quality Certification Program which regulates discharges of fill and dredged material under Section 401 of the Clean Water Act and the Porter-Cologne Water Quality Control Act. Projects that require a Corps permit, or fall under other federal jurisdiction, and have the potential to impact “Waters of the State,” are required to comply with the terms of the Water Quality Certification determination. If a proposed project does not require a federal permit, but does involve dredge or fill activities that may result in a discharge to “Waters of the State,” the RWQCB has the option to regulate the dredge and fill activities under its state authority in the form of Waste Discharge Requirements.

Streams, Lakes, and Riparian Habitat

Streams and lakes, as habitat for fish and wildlife species, are subject to jurisdiction by CDFG under Sections 1600-1616 of the State Fish and Game Code. Alterations to or work within or

adjacent to streambeds or lakes generally require a 1602 Lake and Streambed Alteration Agreement. The term stream, which includes creeks and rivers, is defined in the California Code of Regulations (CCR) as follows: “a body of water that flows at least periodically or intermittently through a bed or channel having banks and supports fish or other aquatic life. This includes watercourses having a surface or subsurface flow that supports or has supported riparian vegetation” (14 CCR 1.72). In addition, the term stream can include ephemeral streams, dry washes, watercourses with subsurface flows, canals, aqueducts, irrigation ditches, and other means of water conveyance if they support aquatic life, riparian vegetation, or stream-dependent terrestrial wildlife (CDFG ESD 1994). Riparian is defined as, “on, or pertaining to, the banks of a stream;” therefore, riparian vegetation is defined as, “vegetation which occurs in and/or adjacent to a stream and is dependent on, and occurs because of, the stream itself” (CDFG ESD 1994). Removal of riparian vegetation also requires a Section 1602 Lake and Streambed Alteration Agreement from CDFG.

Riparian and freshwater habitats are identified as biological communities targeted for conservation in the Resource Conservation Element of the Santa Clara County General Plan (County of Santa Clara 1995). While riparian setbacks for development are described in the SCC General Plan as “flexible”, a recommendation is provided of 150 feet setback from the top of bank for development near streams in a natural state. No County ordinance explicitly defines a stream setback limit for development. Stream setbacks are approved on a project-by-project basis through discussion with County planners.

Other Sensitive Biological Communities

Other sensitive biological communities not discussed above include habitats that fulfill special functions or have special values. Natural communities considered sensitive are those identified in local or regional plans, policies, regulations, or by CDFG. CDFG ranks sensitive communities as “threatened” or “very threatened” and keeps records of their occurrences in its California Natural Diversity Database (CNDDDB). Sensitive plant communities are also identified by CDFG on their *List of California Natural Communities Recognized by the CNDDDB*. Impacts to sensitive natural communities identified in local or regional plans, policies, regulations or by the CDFG or U.S. Fish and Wildlife Service (USFWS) must be considered and evaluated under CEQA (California Code of Regulations: Title 14, Div. 6, Chap. 3, Appendix G).

Specific habitats including baylands, riparian and freshwater areas, grassland and savanna, chaparral, mixed woodland, and evergreen forest habitats are generally identified for conservation in the Resource Conservation Element of the Santa Clara County General Plan although specific ordinances for their conservation have yet to be developed. Implementation policies that apply to these habitat types include conformance with state and federal laws regarding commercial timber sales and endangered species preservation. The SCC General Plan specifies that conservation of these habitat types is important for the maintenance of wildlife habitat linkages and surface water quality.

2.2 Special Status Species

Special status species include those plants and wildlife species that have been formally listed, are proposed as endangered or threatened, or are candidates for such listing under the federal Endangered Species Act (ESA) or California Endangered Species Act (CESA). These acts afford protection to both listed and proposed species. In addition, CDFG Species of Special Concern, which are species that face extirpation in California if current population and habitat trends continue, USFWS Birds of Conservation Concern, sensitive species included in USFWS Recovery Plans, and CDFG special status invertebrates are all considered special status species. Although CDFG Species of Special Concern generally have no special legal status,

they are given special consideration under CEQA. In addition to regulations for special status species, most birds in the United States are protected by the Migratory Bird Treaty Act of 1918. Under this legislation, destroying active nests, eggs, and young is illegal. Plant species on California Native Plant Society (CNPS) Lists 1 and 2 are also considered special status plant species. Impacts to these species are considered significant according to CEQA. CNPS List 3 and 4 plants have little or no protection under CEQA, but are included in this analysis for completeness.

Critical Habitat

Critical habitat is a term defined and used in the Federal Endangered Species Act as a specific geographic area that contains features essential for the conservation of a threatened or endangered species and that may require special management and protection. The FESA requires federal agencies to consult with the USFWS to conserve listed species on their lands and to ensure that any activities or projects they fund, authorize, or carry out will not jeopardize the survival of a threatened or endangered species. In consultation for those species with critical habitat, federal agencies must also ensure that their activities or projects do not adversely modify critical habitat to the point that it will no longer aid in the species' recovery. In many cases, this level of protection is similar to that already provided to species by the FESA "jeopardy standard." However, areas that are currently unoccupied by the species but which are needed for the species' recovery, are protected by the prohibition against adverse modification of critical habitat.

Santa Clara Valley Habitat Conservation Plan

The Santa Clara Valley Habitat Conservation Plan / Natural Communities Conservation Plan (HCP/NCCP) is currently in preparation. Although the RPA Area lies outside the limits of the HCP/NCCP, species covered in this plan are also considered in this assessment as they are regionally important for conservation.

3.0 METHODS

On January 21 and 27, and February 9, 10, and 12, 2009, the RPA Area was traversed on foot to determine (1) biological communities present within the RPA Area, (2) if existing conditions provided suitable habitat for any special status plant or wildlife species, and (3) if sensitive habitats are present. Additional site visits were made in April and June, 2008, to survey for special status plant species.

3.1 Vegetation Communities

Prior to the site visit, the Soil Survey of the Santa Clara Area, California (U.S. Department of Agriculture [USDA] 1958), the USFWS National Wetland Inventory, and USDA aerial photos were examined to determine if any unique soil types, vegetative features, and/or aquatic features that could support sensitive plant communities were present in the RPA Area. Vegetation communities present in the RPA Area were classified based on existing plant community descriptions described in the Preliminary Descriptions of the Terrestrial Natural Communities of California (Holland 1986). However, in some cases it is necessary to identify variants of community types or to describe non-vegetated areas that are not described in the literature.

3.2 Sensitive Biological Communities and Aquatic Features

Biological communities identified within the RPA Area were evaluated to determine if they are considered sensitive or non-sensitive as defined by CEQA and other applicable laws and regulations.

3.2.1 Wetlands and Waters

Wetland areas are identified as areas dominated by plant species with a wetland indicator status¹ of OBL, FACW, or FAC as given on the U.S. Fish and Wildlife Service List of Plant Species that Occur in Wetlands (Reed 1988). Evidence of wetland hydrology can include direct evidence (primary indicators), such as visible inundation or saturation, surface sediment deposits, algal mats and drift lines, or indirect indicators (secondary indicators), such as oxidized root channels. Some indicators of wetland soils include dark colored soils, soils with a sulfidic odor, and soils that contain redoximorphic features as defined by the Corps Manual and Field Indicators of Hydric Soils in the United States (NRCS 2002).

Areas that are inundated for sufficient duration and depth to exclude growth of hydrophytic vegetation, such as lakes and ponds, or convey water, such as streams, are also subject to Section 404 jurisdiction. In the Central California Coast, these “other waters” can include intermittent and ephemeral streams, as well as lakes, and rivers. The RPA Area was evaluated for the presence of “other waters.”

Areas delineated as “Waters of the US” are characterized by an ordinary high water (OHW) mark, defined as:

“...that line on the shore established by the fluctuations of water and indicated by physical characteristics such as clear, natural line impresses on the bank, shelving, changes in the characteristics of the soil, destruction of terrestrial vegetation, the presence of litter and debris, or other appropriate means that consider the characteristics of the surrounding areas.”

Federal Register Vol. 51, No. 219,
Part 328.3 (d). November 13, 1986

“Other waters” are identified in the field by the presence of a defined river or stream bed, a bank, and evidence of the flow of water, or by the absence of emergent vegetation in ponds or lakes. Corps jurisdiction of waters in non-tidal areas extends to the ordinary high water (OHW) mark. “Other waters” that were found within the RPA Area were mapped and are described in the Results section of this report; however, some may be exempt from regulation under the Clean Water Act. “Waters of the State” may include additional aquatic areas not meeting federal definitions. Where this occurred, they were mapped as “Waters of the State”. “Waters of the US” and “Waters of the State” were either mapped using sub-meter accuracy GPS units, or were mapped based on USGS topographic maps and aerial photograph interpretation; stream widths were noted from field observations.

¹ OBL = Obligate, always found in wetlands (> 99% frequency of occurrence); FACW = Facultative wetland, usually found in wetlands (67-99% frequency of occurrence); FAC = Facultative, equal occurrence in wetland or non-wetlands (34-66% frequency of occurrence).

3.2.2 *Riparian Habitat*

An inspection was conducted to determine if the banks of drainages, streams and other aquatic features within the RPA Area supported hydrophytic or stream-dependent woody plant species (riparian species). Streams supporting riparian vegetation were noted and the area of the riparian habitat was estimated and mapped using ArcGIS software.

3.2.3 *Other Sensitive Biological Communities*

The RPA Area was evaluated for the presence of other sensitive biological communities recognized by CDFG or other local or regional policies. All biological communities in the RPA Area were mapped and are described in Section 4.1 below.

3.3 **Special Status Species**

3.3.1 *Literature Review*

Potential occurrence of special status species in the RPA Area was evaluated by first determining which special status species occur in the vicinity of the RPA Area through a literature and database search. Database searches for known occurrences of special status species focused on the Cupertino 7.5 minute USGS quadrangle and the eight surrounding USGS quadrangles. The following sources were reviewed to determine which special status plant and wildlife species have been documented to occur in the vicinity of the RPA Area:

- California Natural Diversity Database records (CNDDDB) (CDFG January 2009)
- USFWS quadrangle species lists (USFWS January 2008)
- CNPS Electronic Inventory records (CNPS January 2008)
- CDFG publication "California's Wildlife, Volumes I-III" (Zeiner et al. 1990)
- CDFG publication "Amphibians and Reptile Species of Special Concern in California" (Jennings 1994)
- A Field Guide to Western Reptiles and Amphibians (Stebbins, R.C. 2003)
- National Oceanic and Atmospheric Administration NMFS Distribution Maps for California Salmonid Species (1999)
- Santa Clara Valley HCP (January 2008)

3.3.2 *Site Assessment*

A site visit was made to the RPA Area to search for suitable habitats for species identified in the literature review as occurring in the vicinity. The potential for each special status species to occur in the RPA Area was then evaluated according to the following criteria:

- No Potential. Habitat on and adjacent to the site is clearly unsuitable for the species requirements (foraging, breeding, cover, substrate, elevation, hydrology, plant community, site history, disturbance regime).
- Unlikely. Few of the habitat components meeting the species requirements are present, and/or the majority of habitat on and adjacent to the site is unsuitable or of very poor quality. The species is not likely to be found on the site.
- Moderate Potential. Some of the habitat components meeting the species requirements are present, and/or only some of the habitat on or adjacent to the site is unsuitable. The species has a moderate probability of being found on the site.
- High Potential. All of the habitat components meeting the species requirements are present and/or most of the habitat on or adjacent to the site is highly suitable. The species has a high probability of being found on the site.

- Present. Species is observed on the site or has been recorded (i.e. CNDDDB, other reports) on the site recently.

The site assessment is intended to identify the presence or absence of suitable habitat for each special status species known to occur in the vicinity in order to determine its potential to occur in the RPA Area. With the exception of the rare plant surveys described below, the site visit does not constitute a protocol-level survey and is not intended to determine the actual presence or absence of a species; however, if a special status species is observed during the site visit, its presence will be recorded and discussed. Appendix A presents the evaluation of potential for occurrence of each special status plant and wildlife species known to occur in the vicinity of the RPA Area with their habitat requirements, potential for occurrence, and rationale for the classification based on criteria listed above.

3.3.3 *Rare plant surveys*

Protocol-level surveys were conducted during the appropriate blooming windows in spring and summer, 2008. The botanists conducting the surveys have experience with the rare plant species that could occur in the area. The surveys followed the protocol for plant surveys described by Nelson (1987). This protocol complies with recommended resource agency guidelines (CNPS 2001, CDFG 2000, USFWS 1996). In some portions of the RPA Area, density of poison oak proved to be significant obstacles to effectively surveying according to these methods. In these cases, all attempts were made to view the area from alternative locations, however not all areas were able to be surveyed according to protocols.

All plants were identified using The Jepson Manual (Hickman 1993), to the taxonomic level necessary to determine whether or not they were rare.

4.0 RESULTS

The RPA Area is located in the northeast portion of the Quarry and is surrounded to the south and west by a cement plant, aggregate rock facility, roads, overburden piles and a quarry. To the east of the RPA Area is primarily developed as residential and to the north is Ranch San Antonio - part of the Mid-peninsula Open Space District. Historically, the RPA Area was steeply sloping rugged terrain dominated by a mosaic of various chaparral communities, open woodlands, and dense forests. The majority of the area drains to Permanente Creek which runs northward to the east of the RPA Area. A second watershed is present immediately to the north of the RPA Area, although this watershed also drains into Permanente Creek downstream of the Permanente property boundary.

The following sections present the results of the biological resources assessment for special status species, sensitive plant communities, and aquatic features within the RPA Area.

4.1 **Vegetation Communities**

Table 1 summarizes the area of each biological community type observed in the RPA Area. Ten (10) distinct vegetation communities are located in the RPA Area. Non-sensitive vegetation types include: 1) ruderal herbaceous grassland, 2) mixed scrub, 3) northern mixed chaparral, 4) chamise chaparral, 5) poison oak scrub, 6) non-native annual grassland, 7) reclaimed areas, 8) active quarry, and 9) settling ponds. The only sensitive biological community observed was: 10) oak woodland. Their general locations and extent are illustrated in Figure 3.

Overview

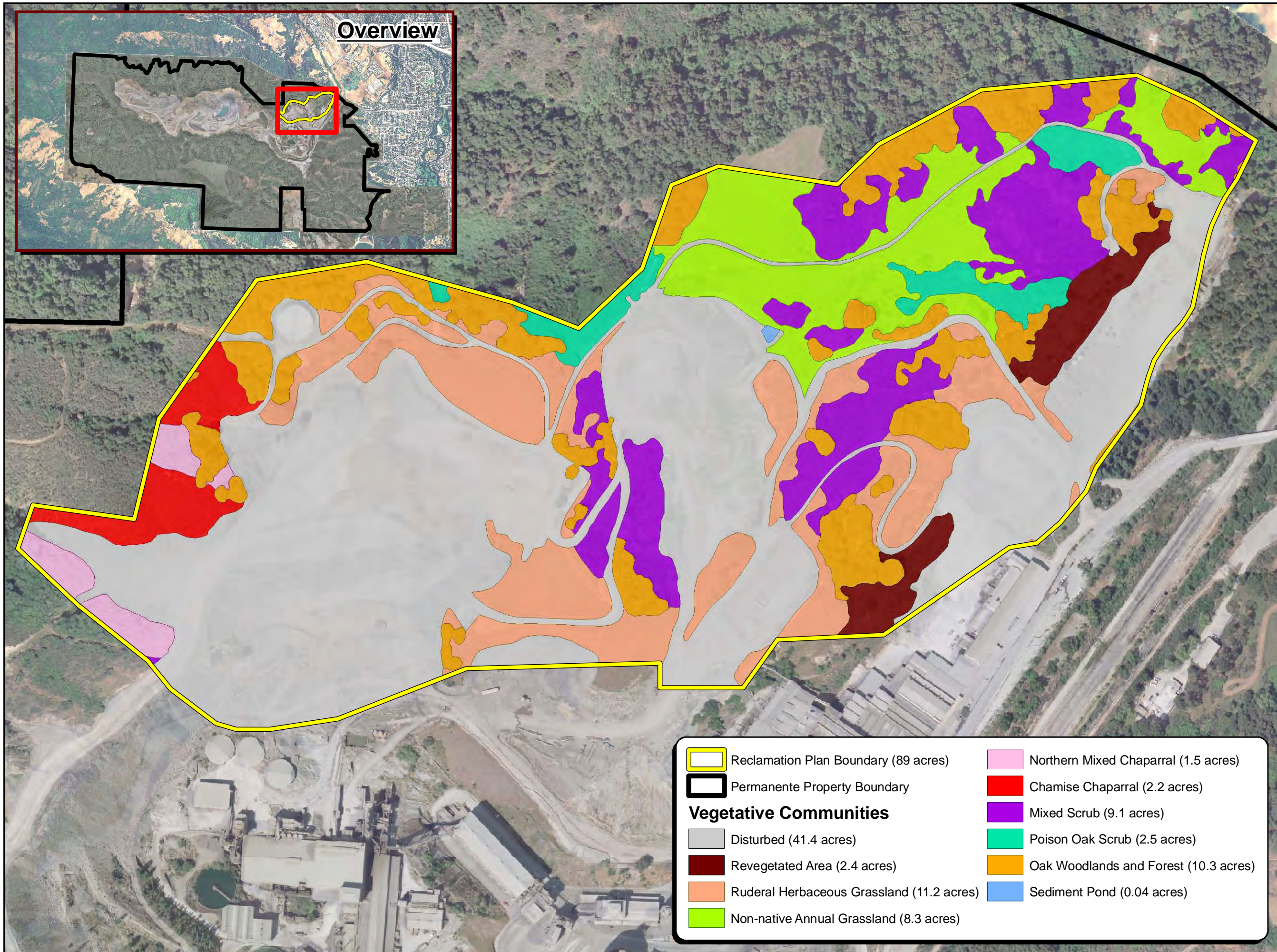
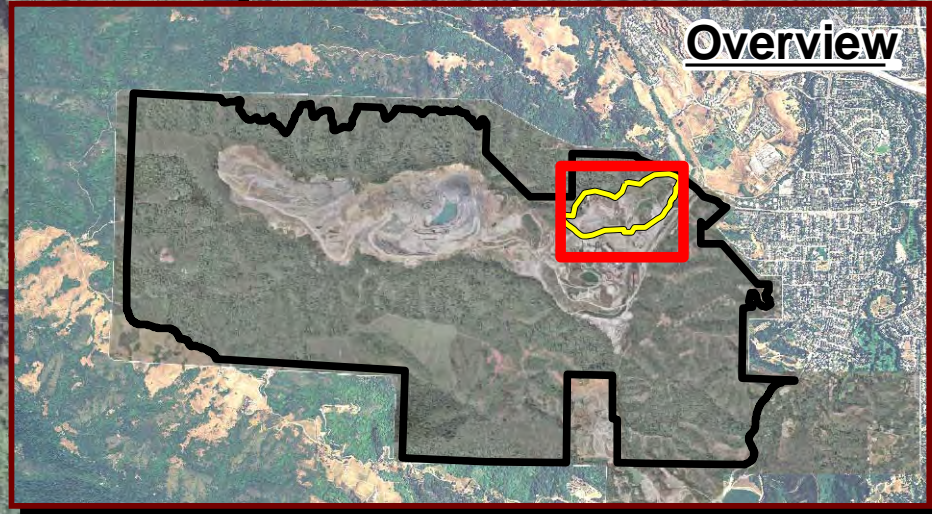


Figure 3.

Vegetative Communities
within the Reclamation
Plan Boundary

Reclamation Plan Boundary (89 acres)	Northern Mixed Chaparral (1.5 acres)
Permanente Property Boundary	Chamise Chaparral (2.2 acres)
Vegetative Communities	
Disturbed (41.4 acres)	Mixed Scrub (9.1 acres)
Revegetated Area (2.4 acres)	Poison Oak Scrub (2.5 acres)
Ruderal Herbaceous Grassland (11.2 acres)	Oak Woodlands and Forest (10.3 acres)
Non-native Annual Grassland (8.3 acres)	Sediment Pond (0.04 acres)

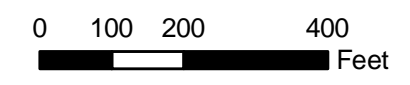


Table 1. Vegetation Communities and Land Use in the RPA Area		
VEGETATION COMMUNITY	CALIFORNIA VEGETATION ALLIANCE (Sawyer and Keeler-wolf, in press)	ACRES
disturbed	not described	41.4
mixed scrub	<i>Baccharis pilularis</i> , <i>Artemisia californica</i> - <i>Eriogonum fasciculatum</i> Alliances	9.1
non-native annual grassland	<i>Avena (barbata, fatua)</i> , <i>Bromus (diandrus, hordeaceus)</i> Alliances	8.3
ruderal herbaceous grassland	<i>Avena (barbata, fatua)</i> , <i>Bromus (diandrus, hordeaceus)</i> , <i>Centaurea (solstitialis, melitensis)</i> Alliances	11.2
oak woodland	<i>Quercus agrifolia</i> , <i>Q. wislezeni</i> , <i>Q. douglasii</i>	10.3
revegetated areas	not described	2.4
chamise chaparral	<i>Adenostoma fasciculatum</i> Alliance	2.2
poison oak scrub	<i>Toxicodendron diversilobum</i> Alliance	2.5
northern mixed chaparral	<i>Ceanothus oliganthus</i> , <i>C. cuneatus</i> , <i>Arctostaphylos glandulosa</i> , <i>Heteromeles arbutifolia</i> Alliances	1.5
settling ponds	not described	<0.1
TOTAL		88.9

4.1.1 Non-Sensitive Vegetation Community Types

Disturbed - Areas identified in the RPA Area as disturbed have been altered by quarry activities. These areas have yet to be reclaimed and typically host a very small number of weedy and/or native plant species including yellow star thistle, coyote brush, chamise, wild oats, sweet fennel (*Foeniculum vulgare*), and field mustard. Generally, plant cover in these areas is very sparse due to the lack of topsoil. This community offers poor habitat for plants or animals.

Mixed Scrub - Mixed scrub includes shrub-dominated communities dominated by coyote brush (*Baccharis pilularis*), California sagebrush (*Artemisia californica*), and California buckwheat (*Eriogonum fasciculatum*) partially described as Diablan Sage Scrub by Holland (1986). This community occurs on shallow rocky soils, typically on hot southern exposures of the coast range from Oregon to Central California in areas out of the range of coastal fog incursion.

Mixed scrub was mapped throughout the RPA Area on southern exposures. Additionally, small patches of this community type were mapped throughout the RPA Area where coyote brush or California buckwheat is the dominant shrub type. Mixed scrub in the RPA Area is characterized as dense to moderately open stands to 1.5 meters tall dominated by coyote brush, California sagebrush, and/or California buckwheat with little to no understory vegetation. Associated species include sticky monkey flower (*Mimulus aurantiacus*), poison oak (*Toxicodendron diversilobum*), deerweed (*Lotus scoparius*), black sage (*Salvia mellifera*), golden yarrow (*Eriophyllum confertiflorum*), and California cudweed (*Gnaphalium californica*). In the RPA Area, this community type intergrades with chaparrals and oak woodlands. Associated wildlife

species in this community type include Hermit Thrush (*Catharus guttatus*), Northern Pacific Rattlesnake (*Crotalus viridis oregonus*), and Wrentit (*Chamaea fasciata*).

Ruderal Herbaceous Grassland - Ruderal herbaceous grassland is not described by Holland (1986) but includes habitats previously disturbed and/or reclaimed which have been inactive long enough to recruit a plant community dominated by herbaceous weeds and non-native grasses. Species typical of this plant community in California include brome grasses (*Bromus* sp.), wild oats (*Avena* sp.), Italian thistle (*Carduus pycnocephalus*), wild mustard (*Brassica* sp.), and filaree (*Erodium* sp.). This community is widespread throughout California.

Ruderal herbaceous grassland in the RPA Area primarily occurs on slopes between quarry roads, or in areas adjacent to quarry activities. Species typical of this biological community in the RPA Area include Italian thistle, field mustard (*Brassica rapa*), lupine (*Lupinus* sp.), Mediterranean barley (*Hordeum marinum* ssp. *gussoneanum*), yellow star thistle (*Centaurea solstitialis*), oleander (*Nerium oleander*), and slender wild oats (*Avena barbata*). Associated wildlife species in this plant community include Dark-eyed Junco (*Junco hyemalis*), Ring-necked snake (*Diadophis punctatus*), and California Towhee (*Pipilo crissalis*).

Non-native annual grassland - Non-native annual grassland is described in Holland (1986) as a dense to sparse cover of annual grasses 0.2 to 0.5 meters high. Characteristic species include wild oats, soft chess (*Bromus hordeaceus*), filaree (*Erodium botrys*, *E. cicutarium*, *E. moschatum*), Italian ryegrass (*Lolium multiflorum*), small fescue (*Vulpia microstachys*), and various native and non-native herbs and wildflowers. This community type is distributed throughout the valleys and foothills of most of California below 3000 feet.

Non-native annual grassland was mapped in the RPA Area in various aspects. Non-native annual grassland intergrades with chaparrals and oak woodlands on slopes and ridgelines. Species typical of this community type in the RPA Area include wild oats, ripgut brome (*Bromus diandrus*), soft chess, Italian ryegrass, filaree, small fescue, California poppy (*Eschscholzia californica*), lupines, bird vetch (*Vicia cracca*), and birdfoot trefoil (*Lotus corniculatus*). Additionally, in many areas purple needlegrass (*Nassella pulchra*) was present in substantial patches. Associated wildlife species in this plant community include Western Meadowlark (*Sturnella neglecta*), California Deer Mouse (*Peromyscus californicus*), and Violet-green Swallow (*Tachycineta thalassina*).

Revegetated Areas - Revegetated areas, not described in the literature, are defined here as historically disturbed slopes that have been recolonized by native and/or naturalized non-native vegetation. It appears that in some cases, these areas were graded to a final contour and planted at a low to moderate density with native shrubs and trees. In the RPA Area, the dominant species in these areas are coast live oak, coyote brush, purple sage (*Salvia leucophylla*), and a minor non-native grass component. The reclaimed areas in the RPA Area appear to be well established with vigorous shrub growth. Associated wildlife species in this plant community include Bewick's Wren (*Thryomanes bewickii*), and Spotted Towhee.

Chamise Chaparral - Chamise chaparral is a chaparral community dominated by 1 to 3 meter tall chamise with associated species contributing little to overall cover and mature stands containing very little herbaceous understory (Holland 1986). Associated species typically include Manzanita species, scrub oak, buckbrush, birch-leaf mountain mahogany, yerba santa, sage (*Salvia* sp.), and California buckwheat. It has a general distribution similar to northern mixed chaparral, but is more abundant in southern California.

Chamise chaparral in the RPA Area was mapped on southern exposures with shallow soils. Chamise chaparral in the RPA Area ranges from 0.5 to 3 meters tall, forming impenetrable

stands with no herbaceous understory. It intergrades with northern mixed chaparral on eastern exposures and abruptly borders oak woodland and oak chaparral at ridgelines. Occasional associates include scrub oak, toyon (*Heteromeles arbutifolia*), and madrone (*Arbutus menziesii*). Associated wildlife species in this community type include Spotted Towhee, Bewick's Wren, and Anna's Hummingbird (*Calypte anna*).

Poison oak scrub - Briefly described in Holland (1986), poison oak scrub is a shrub-dominated community maintained by frequent fires or other disturbance and completely dominated by poison oak. Its distribution in California is not described. Poison oak scrub in the RPA Area contains extremely dense, monotypic stands of poison oak to 2 meters tall. There are no other species associated with this community type. Associated wildlife species in this community type include Ruby-crowned Kinglet (*Regulus calendula*), Wrentit, and San Francisco Dusky-footed Woodrat (*Neotoma fuscipes annectens*).

Northern Mixed Chaparral - Northern mixed chaparral is a community of broadleaved sclerophyll shrubs 2 to 4 meters tall forming dense often impenetrable stands dominated by chamise (*Adenostoma fasciculatum*), scrub oak (*Quercus berberidifolia*), various manzanitas (*Arctostaphylos* sp.), and various members of the genus *Ceanothus* (Holland 1986). This community type occurs on dry, rocky, steep, typically south-facing slopes with thin soil. It usually occurs below 3000 feet elevation in Northern California. It is widely distributed throughout the mountain ranges of California.

In the RPA Area, northern mixed chaparral was mapped in one small location on an south-facing slopes. Northern mixed chaparral in the RPA Area forms dense impenetrable stands 2 to 3 meters tall with high species diversity in the shrub strata. It intergrades with oak woodlands and oak scrubs on deeper soils, and chamise chaparral on southern exposures. Species typical of this community type in the RPA Area include chamise, scrub oak, Eastwood's Manzanita (*Arctostaphylos glandulosa* ssp. *glandulosa*), jimbrush (*Ceanothus oliganthus* var. *sorediatus*), buckbrush (*Ceanothus cuneatus*), birch-leaf mountain mahogany (*Cercocarpus betuloides*), poison oak, yerba santa (*Eriodictyon californicum*), white pitcher sage (*Lepichinia calycina*), coffeeberry (*Rhamnus californicus*), and redberry (*Rhamnus crocea*). There is little to no understory. Where present, common understory herbs include Indian warrior (*Pedicularis densiflorus*), Pacific sanicle (*Sanicula crassicaulis*), coyote mint (*Monardella villosa* ssp. *villosa*), and Indian paintbrush (*Castilleja affinis* ssp. *affinis*). Associated wildlife species in this community type include Brush Rabbit (*Sylvilagus bachmani*), California Thrasher (*Toxostoma redivivum*), and California Quail (*Callipepla californica*).

Settling basin - One man-made settling basin for quarry runoff was identified in the RPA Area as shown in Figure 3.

4.1.2 Sensitive Biological Communities

Oak Woodlands - Oak woodland community types are described in more detail in Holland (1986), but were lumped in this vegetation mapping effort due to the lack of dominance of one oak species in most of the woodlands encountered. The RPA Area's oak woodlands are described as Blue Oak Woodland and Coast Live Oak Woodland in Holland (1986). Species characteristic of these oak woodland types include blue oak (*Quercus douglasii*), coast live oak (*Quercus agrifolia*), canyon live oak (*Quercus wisleyeni*), California buckeye (*Aesculus californica*), California bay (*Umbellularia californica*), elderberry (*Sambucus mexicana*), toyon, madrone, coffeeberry, poison oak, gooseberries (*Ribes* sp.), and manzanitas. These oak woodland types are distributed throughout California typically in protected valleys and north-facing slopes, intergrading with chaparrals on drier sites.

Oak woodlands were mapped within the RPA Area primarily along north- and east-facing slopes and in small drainages. Oak woodlands in the RPA Area are predominantly characterized as coast live oak and blue oak woodlands; however, a few small pockets of oak woodland dominated by interior live oak are also present. The majority of oak woodlands in the RPA Area are isolated relict patches in otherwise disturbed surroundings. However, portions of the northern boundary of the RPA Area support relatively intact areas of blue and coast live oak woodland. These areas have dense overstories dominated by oak species without a substantial number of subdominant species. Other overstory species include California bay and California buckeye. Species characteristic of the understory include poison oak, coffeeberry, ocean spray (*Holodiscus discolor*), elderberry, toyon, and gooseberries. Wildlife observed in the oak woodland plant community in the RPA Area include White-tailed Kite (*Elanus leucurus*), Oak Titmouse (*Oak Titmouse*), Black-tailed Deer (*Odocoileus hemionus columbianus*), and California Deer Mouse (*Peromyscus californicus*).

4.2 Special Status Species

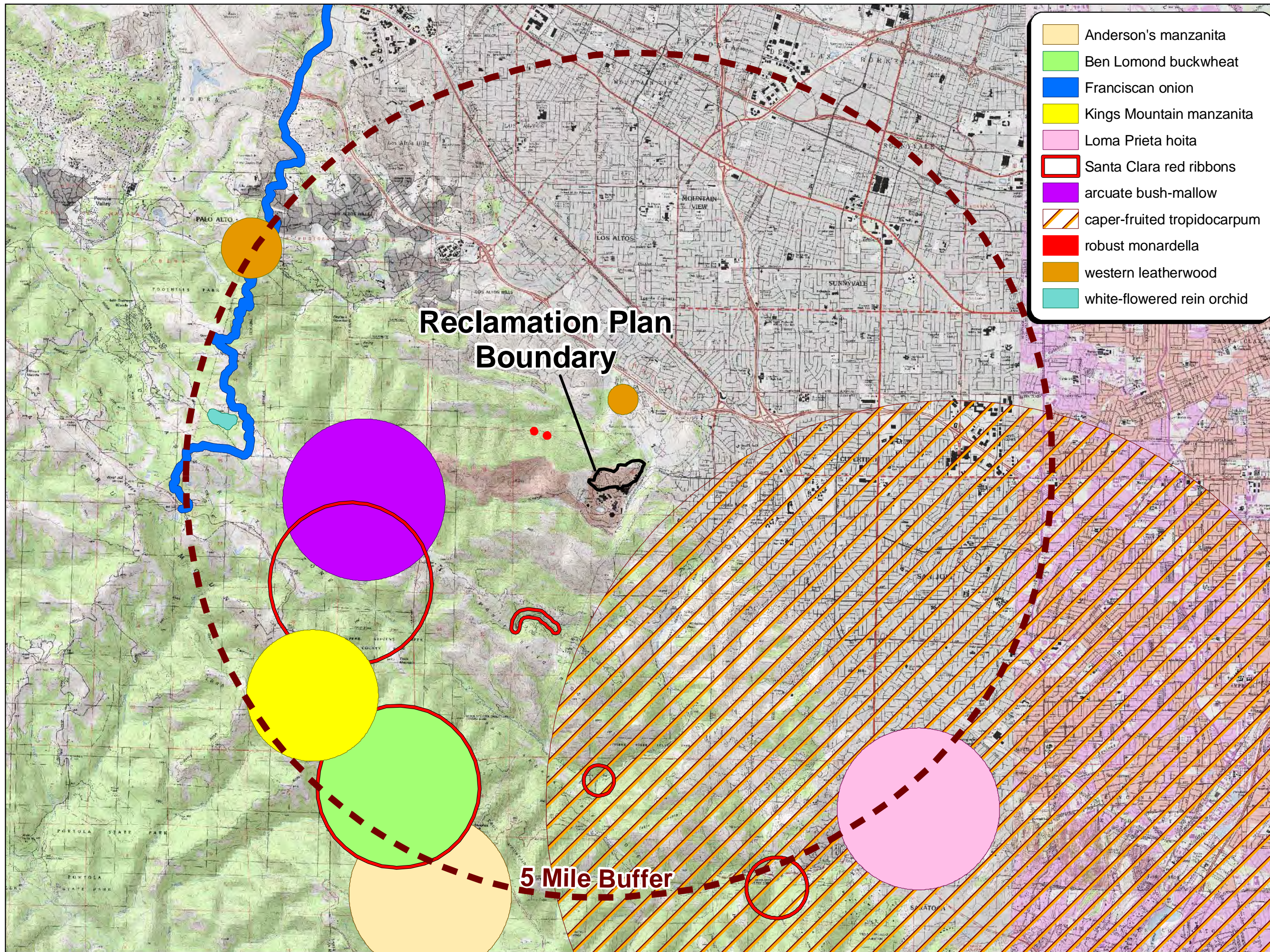
4.2.1 Plants

Based upon a review of the resources and databases given in Section 3.3.1, eighty-one (81) plant species which have been given special protection status under state and federal species legislation occur in the vicinity of the RPA Area. These species and their likelihood of occurrence in the RPA Area are presented in Appendix A.

Based on a reconnaissance level site visit and review of the literature, thirteen of the eighty-one listed species were determined to have the potential to occur in the RPA Area due to their habitat requirements, known distribution, and the habitats provided in the RPA Area. Fourteen species were determined to be unlikely to occur in the RPA Area. Fifty-four of the listed species were determined to have no potential to occur on site based on the lack of specific habitat requirements of the species such as coastal salt marsh or serpentine soils in the RPA Area. Protocol-level rare plant surveys were then performed to verify the presence or absence of the thirteen species with moderate or high potential to occur; however, notes regarding the fourteen unlikely species were included in the field surveys.

CNDDDB records (Figure 4) indicate that four special status plant species have been recorded near the RPA Area. Caper-fruited tropidocarpum (*Tropidocarpum capparideum*) is reported to the southeast of the RPA Area, but the record presented is an approximately five-mile radius circle around a reported collection from 1907, which may have been misidentified. Arcuate bushmallow (*Malacothamnus arcuatus*) is reported to the west of the RPA Area near Black Mountain, but the occurrence is an approximately one-mile radius circle around an uncertain location reported in 1926. Robust monardella (*Monardella villosa* ssp. *globosa*) has been recorded to the immediate northwest of the RPA Area as recently as 2006, but field investigations by WRA biologists in the exact locations of these occurrences did not confirm the presence of this subspecies. In the vicinity of the reported occurrence, several populations of a common subspecies (*Monardella villosa* ssp. *villosa*) were observed. Western leatherwood (*Dirca occidentalis*) is known from neighboring parcels less than one mile from the RPA Area. It is our conclusion that these four reported species are not present in the RPA Area.

Mid- and late-season protocol field surveys were conducted in April and June, 2008. The surveys corresponded to peak blooming periods for observing and accurately identifying ten of the thirteen rare plant species with potential to occur within the RPA Area vicinity. The remaining species are identifiable outside their blooming period (one perennial shrub, one lichen, and one moss).



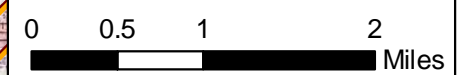
- Anderson's manzanita
- Ben Lomond buckwheat
- Franciscan onion
- Kings Mountain manzanita
- Loma Prieta hoita
- Santa Clara red ribbons
- arcuate bush-mallow
- caper-fruited tropidocarpum
- robust monardella
- western leatherwood
- white-flowered rein orchid

East Materials Storage Area,
Lehigh Permanente Quarry,
Santa Clara County,
California

Figure 4.

Special Status Plant
Occurrences within
Five Miles of the
Reclamation Plan
Boundary

*(Based on CNDDDB
2009 Data)*



A list of observed plant species is provided in Appendix B and a list of species with the potential to occur in the RPA Area is provided in Appendix A. One CNPS List 4 species was observed during surveys; however, this species is not protected under CEQA. No other special status plant species were observed during any of the protocol-level surveys in the RPA Area.

CNPS List 4 species - One CNPS List 4 species was observed during rare plant surveys. List 4 species are not afforded protection under CEQA; however, they are identified as potentially limited in distribution, and may become listed species in the future. Santa Catalina Island buckwheat (*Eriogonum giganteum* ssp. *giganteum*) has a native distribution restricted only to Santa Catalina Island off the coast of Los Angeles, California. A small population of this species was identified in a reclaimed area near the cement plant. It has a history of horticultural plantings outside its native range (Hickman 1993) and thus was presumably planted within the active quarry in a reclaimed area revegetated for erosion control (Figure 3). Observation location data for this species may be requested from WRA.

4.2.2 Wildlife

Forty-five special status wildlife species have been recorded in the vicinity of the RPA Area. These species and their likelihood of occurrence are presented in Appendix A. Figure 5 shows CNDDDB documented special status wildlife occurrences within five miles of the RPA Area. Of these, two species has been documented to occur within the RPA Area: San Francisco Dusky-footed Woodrat and White-tailed kite. A California Tiger Salamander (*Ambystoma californiense*) occurrence is documented adjacent to the RPA Area; however, the validity of this occurrence is questioned (see discussion in Section 4.2.2.3). One species has a high potential to occur: Grasshopper Sparrow (*Ammodramus savannarum*). Two additional species have a moderate potential to occur: Pallid Bat (*Antrozous pallidus*) and Loggerhead Shrike (*Lanius ludovicianus*). California Red-legged Frog (*Rana aurora draytonii*) is known to occur and breed along Permanente Creek, however due to the lack of suitable aquatic habitat, limitation of RPA activities to greater than 300 feet from suitable aquatic habitat, and barriers to dispersal, CRLF are unlikely to occur within the RPA Area.

Special status wildlife species that are present or have a high potential to occur in the RPA Area are discussed below. The validity of the documented California Tiger Salamander occurrence is discussed in detailed below.

4.2.2.1 Species present in the RPA Area

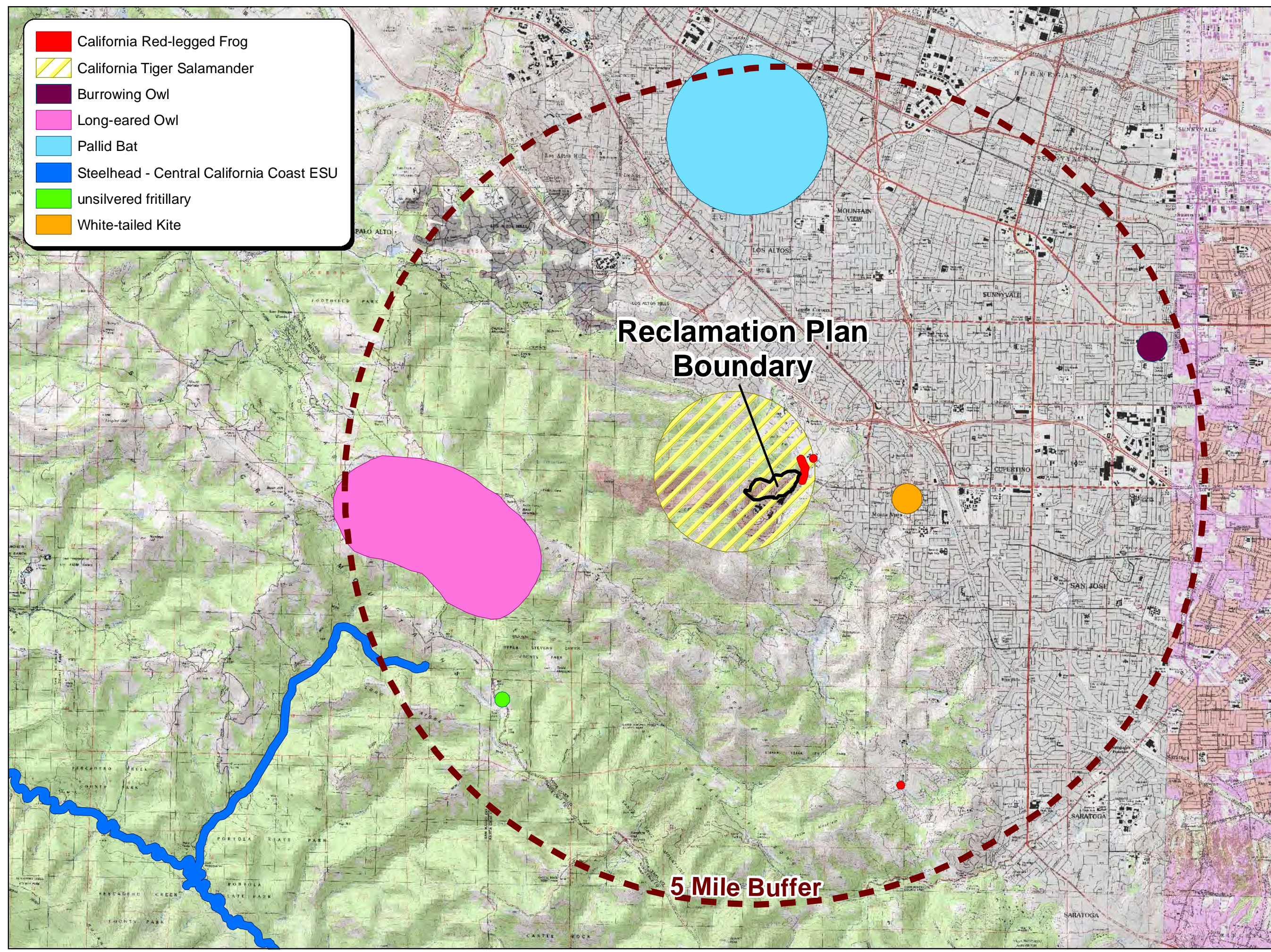
San Francisco Dusky-footed Woodrat (*Neotoma fuscipes annectens*), CDFG Species of Special Concern. This subspecies of the Dusky-footed Woodrat occurs in the Coast Ranges between San Francisco Bay and the Salinas River (Matocq 2003). It prefers brushy riparian habitats, coast live oak woodland, and dense scrub communities. Prominent stick houses provide evidence of its presence.

Within the RPA Area, San Francisco Dusky-footed Woodrats have been observed by WRA biologists. This species' large stick houses are commonly found in vegetated areas where suitable building materials are present. The locations of observed woodrat houses were mapped (Figure 6).

White-tailed Kite (*Elanus leucurus*), California Fully Protected Species. Kites occur in low elevation grassland, agricultural, wetland, oak woodland, and savannah habitats. Riparian zones adjacent to open areas are also used. Vegetative structure and prey availability seem to be more important than specific associations with plant species or vegetative communities.

- California Red-legged Frog
- California Tiger Salamander
- Burrowing Owl
- Long-eared Owl
- Pallid Bat
- Steelhead - Central California Coast ESU
- unsilvered fritillary
- White-tailed Kite

East Materials Storage Area,
Lehigh Permanente Quarry,
Santa Clara County,
California



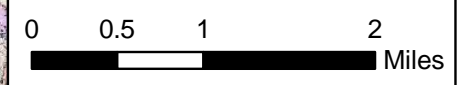
**Reclamation Plan
Boundary**

5 Mile Buffer

Figure 5.

Special Status Wildlife
Occurrences within
Five Miles of the
Reclamation Plan
Boundary

*(Based on CNDDDB
2009 Data)*



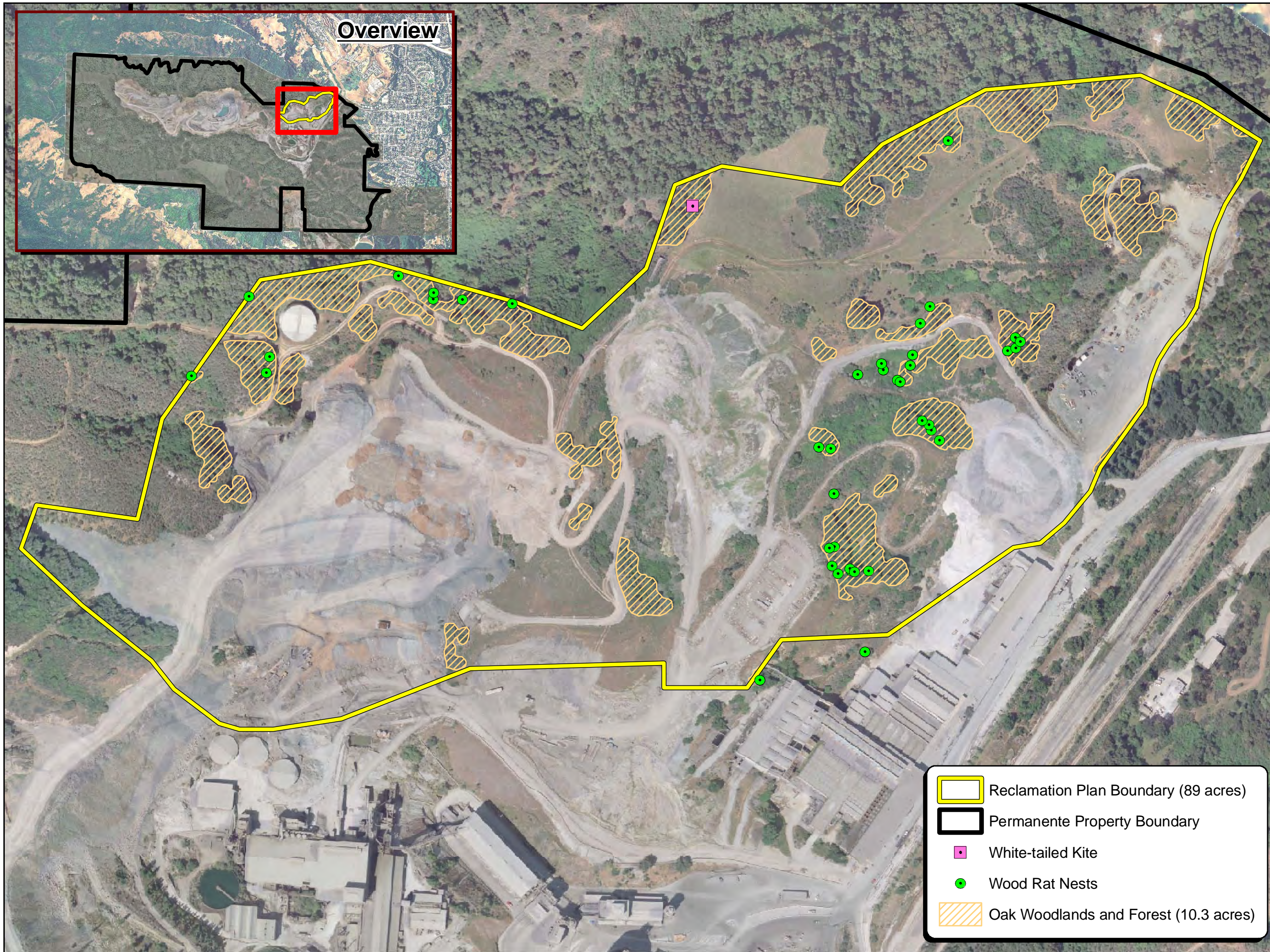
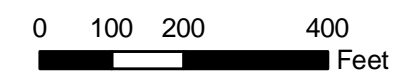


Figure 6.
Sensitive Occurrences
and Communities
within the Reclamation
Plan Boundary

- Reclamation Plan Boundary (89 acres)
- Permanente Property Boundary
- White-tailed Kite
- Wood Rat Nests
- Oak Woodlands and Forest (10.3 acres)



Lightly grazed or ungrazed fields generally support large prey populations and are often preferred to other habitats. Kites primarily feed on small mammals, although, birds, reptiles, amphibians, and insects are also taken. Nest trees range from single isolated trees to trees within large contiguous forests. Preferred nest trees are extremely variable, ranging from small shrubs (less than 10 ft. tall), to large trees (greater than 150 ft. tall) (Dunk 1995).

A pair of White-tailed Kites were observed foraging and exhibiting what appeared to be pair bonding behavior along the northern portion of the RPA Area on February 10, 2009. This behavior frequently precedes nest building by White-tailed Kites. No nest structures were observed in the RPA Area during the site visit, however, it is possible that nesting may occur within or adjacent to the RPA Area.

4.2.2.2 Species with a high or moderate potential to occur within the RPA Area

Pallid bat (*Antrozous pallidus*), CDFG Species of Special Concern, WBWG High Priority. The Pallid Bat is found in a variety of low elevation habitats throughout California. It selects a variety of day roosts including rock outcrops, mines, caves, hollow trees, buildings, and bridges. Night roosts are usually found under bridges, but also in caves, mines, and buildings. Pallid bats are sensitive to roost disturbance. Unlike most bats, Pallid Bats primarily feed on large ground-dwelling arthropods, and prey are typically taken on the ground (Zeiner et al. 1990). Hollow trees in the oak woodland provide potential roost habitat for this species; therefore, there is a moderate potential for occurrence for this bat.

The RPA Area supports several stands of large mature stands of oak trees which contain suitable cavities capable of supporting roosting Pallid Bats. The highest quality stands of trees are located along the northern RPA Area boundary and are contiguous with Rancho San Antonio to the north. Other stands of trees within the RPA Area are highly fragmented and subject to disturbance associated with ongoing quarry activities. These other areas are marginal in quality and unlikely to support roosting bats. The nearest documented occurrence of this species is 5.0 miles north of the RPA Area (CNDDDB 2008). There is a moderate potential for this species to roost within or immediately adjacent to the RPA Area.

Grasshopper Sparrow (*Ammodramus savannarum*), California Species of Special Concern. This species generally prefers moderately open grasslands and prairies with patchy bare ground. They select different components of vegetation depending on grassland ecosystem. This sparrow typically avoids grasslands with extensive shrub cover, although some level of shrub cover is important for birds in western regions (Vickery 1996).

Grasshopper Sparrows are ground nesting birds. The nest cup is domed with overhanging grasses and a side entrance. Eggs are usually laid in early to mid June and hatch 12 days later. Males and females provide care to the young and second broods are common. This species primarily feeds on insects (Vickery 1996).

Grasshopper Sparrows have been observed consistently within sparsely vegetated areas within the active quarry adjacent to the RPA Area. Suitable foraging and breeding habitat for this species is present within portions of the RPA Area where shrub, grasslands and bare ground create a habitat mosaic.

Loggerhead Shrike (*Lanius ludovicianus*), CDFG Species of Special Concern, USFWS Bird of Conservation Concern. The Loggerhead Shrike is a common resident and winter visitor in lowlands and foothills throughout California. It prefers open habitats with scattered trees, shrubs, posts, fences, utility lines or other perches. Nests are usually built on a stable branch in a densely-foliaged shrub or small tree and are usually well-concealed. The highest

densities occur in open-canopied valley foothill hardwood, valley foothill hardwood-conifer, valley foothill riparian pinyon-juniper, juniper, and desert riparian habitats. While this species eats mostly arthropods, they also take amphibians, small to medium-sized reptiles, small mammals and birds, and are also known to scavenge on carrion (Ziener et al. 1990).

Loggerhead Shrike have not been observed within the RPA Area by WRA biologists, however, suitable nesting and foraging habitat is present. There are no documented occurrences of Loggerhead Shrike within 5 miles of the RPA Area (CNDDDB 2008). This species has a moderate potential to occur within the RPA Area.

4.2.2.3 Federally Listed Species Unlikely to occur within the RPA Area

California Tiger Salamander (*Ambystoma californiense*), Federally Threatened. The California Tiger Salamander (CTS) Central Valley Distinct Population Segment (DPS) was listed as Federally Threatened August 4, 2004 (69 FR 47212-47248). Critical Habitat for CTS was designated on August 23, 2005 (70 FR 49379-49458). The RPA Area is not within CTS Critical Habitat. A Recovery Plan is currently under development by the USFWS (2007).

The CTS requires two primary habitat components: aquatic breeding sites and upland terrestrial estivation or refuge sites. This species inhabits valley and foothill grasslands and the grassy understory of open woodlands, usually within one mile of water (Jennings and Hayes 1994). Adult CTS spend most of their time underground in upland subterranean refugia. Underground retreats usually consist of ground-squirrel burrows, but also under logs and piles of lumber (Holland et al. 1990). CTS primarily uses California ground squirrel burrows as upland refuge sites (Loredo et al. 1996, Trenham 2001). Ponds, depressional pools, vernal pools and other wetlands are used by CTS to breed and lay their eggs. These sites must remain inundated for at least 10 weeks, the minimum time needed for larvae to complete metamorphosis.

Dr. Mark Jennings, an expert on rare amphibians, concluded in a report dated August 27, 2008 that previous accounts of CTS being present in the Permanente Creek drainage system were erroneous. Furthermore he assessed the RPA Area to be too disturbed to support CTS. Additionally, within the RPA Area, there are no seasonal waters capable of supporting CTS breeding. The developed nature of the RPA Area has eliminated much of the previously available upland and estivation habitat for this species. Only small numbers of potentially suitable burrows, a key habitat component for this species' lifecycle, remain. The second closest documented occurrence is 6.2 miles north of the RPA Area (CNDDDB 2008), which is much farther than this species' ability to disperse over uplands (0.7 miles; Trenham and Shaffer 2005). Therefore this species is unlikely to occur in the RPA Area.

California Red-legged Frog (*Rana aurora draytonii*), Federally Threatened, CDFG Species of Special Concern. The California Red-legged Frog (CRLF) is a medium-sized frog with reddish-colored legs. The species is generally restricted to riparian and lacustrine habitats in California and northern Baja California. In response to a significant decrease in the historic range of the California Red-legged Frog, the USFWS listed the subspecies as Threatened in 1996. Red-legged Frogs prefer deep, quiet pools in creeks, rivers, or lakes below 1500 meters in elevation. Habitat requirements include fresh emergent or dense riparian vegetation, especially willows adjacent to shorelines. Red-legged Frogs can survive in seasonal bodies of water that are dry for short periods if a permanent water body or dense vegetation stands are nearby; rodent burrows and grasslands provide upland estivation habitat.

Rana Resources had conducted surveys for CRLF on several dates between 2006 and 2008 in Permanente Creek and associated in-stream and out-of-stream settling basins. These surveys found that CRLF currently occupy several ponds approximately 300 feet east of the RPA Area.

Marginal breeding habitat is present in pools along Permanente Creek itself and the creek likely serves as a movement corridor between known breeding populations.

Within the RPA Area, no suitable creeks or ponds exist that remain wetted for a sufficient period to provide aquatic breeding or non-breeding habitat for CRLF. Additionally there are significant barriers to dispersal between occupied CRLF occurrences and the RPA Area. Barriers to dispersal include: developed roads subject to heavy vehicle and equipment traffic, a large warehouse, steep rocky slopes and unvegetated storage yards. CRLF is unlikely to occur in the RPA Area.

5.0 SUMMARY

The proposed amendment to the Reclamation Plan proposes to reclaim the EMSA according to the requirements of the state Surface Mining and Reclamation Act and Santa Clara County surface mining ordinance. Reclamation will occur at elevations from 600 feet to 900 feet above sea level. Upon reclamation, overburden rock will be contoured at 2:1 slopes, interrupted at 40-foot intervals with 25-foot benches for slope stability. Reclamation will include revegetation with native species, and will occur in phases as overburden rock is received by the EMSA, with progressive revegetation of slopes and benches as the planned landforms are completed.

Most of the RPA Area is dominated by non-sensitive and disturbed areas (active quarry, ruderal herbaceous grassland, reclaimed areas) which are not sensitive habitats. Due to a history of disturbance associated with quarry development and operations, these areas provide little habitat for wildlife. Small, fragmented patches of oak woodland, chamise chaparral, and mixed scrub are also present within the RPA Area; however, due to the degree of fragmentation and associated quarry disturbance, these remnant natural habitats are marginal quality for most wildlife species. One sensitive community (oak woodland) was identified within the RPA Area.

One CNPS-listed plant (Santa Catalina Island buckwheat - List 4) is present in the RPA Area; however, only List 1 and 2 plant species are provided protection under CEQA, and this species may have been planted in the area as part of a previous revegetation effort. Two special status wildlife species have been documented to occur within the RPA Area: San Francisco Dusky-footed Woodrat and White-tailed Kite. Three additional special status wildlife species have a high or moderate potential to occur in the RPA Area: Pallid Bat, Grasshopper Sparrow, and Loggerhead Shrike.

5.1 Vegetation Communities

Ten distinct vegetation community types were observed within the RPA Area. Their acreages are presented in Table 1. Their locations and extent are illustrated in Figure 3.

5.1.1 Non-Sensitive Vegetation Communities

The majority of the RPA Area is dominated by non-native annual grassland, chaparral and scrub communities, and disturbed areas (active quarry, ruderal herbaceous grassland, reclaimed areas, and settling ponds) which are not sensitive habitats.

5.1.2 Sensitive Vegetation Communities

Oak woodland is the only sensitive vegetation community present within the RPA Area. Although the majority of the oak woodland community is of relatively poor quality due to its fragmented and isolated nature, the blue-oak dominated woodland along the northern portions

of the RPA Area is relatively intact. Oak woodland may be considered sensitive by regulatory agencies. No riparian plant communities or wetlands or creeks were observed in the RPA Area.

5.2 Special Status Species

5.2.1 Plants

Protocol-level rare plant surveys were performed in April and June of 2008 to determine the presence or absence of listed plant species in the RPA Area. One CNPS List 4 species was observed in the RPA Area, Santa Catalina Island buckwheat; however, it is not afforded any protections under CEQA due to the List 4 status. No special status plant species afforded protection under CEQA were observed during the protocol-level rare plant surveys. Accordingly, the proposed amendment to the Reclamation Plan is not expected to impact any special-status plant species.

5.2.2 Wildlife

Suitable habitat is present for four special status wildlife species in the RPA Area. Two special status wildlife species were observed and another three special status wildlife species have a high or moderate potential to occur in the RPA Area.

5.2.2.1 Woodrat

Within the RPA Area, San Francisco Dusky-footed Woodrats and their stick houses have been observed by WRA biologists. The locations of observed woodrat houses were mapped (Figure 6). This species may inhabit scrub, chaparral, and oak woodlands where a well-developed understory is present. Areas such as these within the RPA area that also contain moderate cover and a well-developed understory containing woody debris may be suitable nesting habitat.

5.2.2.2 Avian species

White-tailed Kites have been observed along the northern portion of the RPA Area. No nesting structures were observed. However, breeding may occur within or adjacent to the RPA Area. Special status bird species that have a high or moderate potential to occur are: Grasshopper Sparrow and Loggerhead Shrike. Mature trees and other dense vegetation are important habitat requirements for birds. Breeding birds may occur within and adjacent to the RPA Area. Nearly all biological communities within the RPA Area potentially support nesting birds protected by the Migratory Bird Treaty Act (MBTA). The active quarry has been operating in its present condition for several decades, to the extent that any hawks or owls occurring in or adjacent to the active quarry have adapted to coexist with the ongoing quarry operations and associated disturbance.

5.2.2.3 Amphibians

CRLF have been documented to adjacent to the RPA Area. Past and ongoing surveys by Dr. Mark Jennings have documented CRLF along Permanente Creek and breeding within in-stream ponds adjacent to the RPA Area. No suitable habitat for federally listed CRLF or CTS is present within the RPA Area. No significant impacts to CRLF are expected to occur from the proposed amendment to the Reclamation Plan.

5.2.2.4 Bats

Pallid Bats have a moderate potential to roost within large mature trees and snags within RPA Area. Stands of mature oak trees along the northern RPA Area boundary have the highest

potential to support roosting Pallid Bats. Other stands of trees within RPA Area are unlikely to support roosting bats as they are highly fragmented and subject to disturbance associated with ongoing quarry activities.

6.0 RECOMMENDATIONS

6.1 Woodrat

The stick houses of the San Francisco Dusky-footed Woodrat have been observed in woodlands and shrublands with dense cover and woody debris within the RPA Area. Construction and construction related activities have the potential to either destroy the houses or disturb the houses, potentially causing abandonment. Prior to ground disturbance active woodrat houses that would be directly impacted should be flagged and avoided if possible. If avoidance is not feasible, the houses shall be dismantled by hand under the supervision of a biologist. If young are encountered during the dismantling process, the material will be placed back on the house and the house will remain unmolested for two to three weeks in order to give the young enough time to mature and leave the house on their own accord. After two to three weeks, the nest dismantling process may begin again. Nest material will be moved to suitable adjacent areas (oak woodland, scrub, or chaparral) that will not be disturbed.

6.2 Avian Species

During initial activities or in areas adjacent to undisturbed woodland, impacts to special status birds or birds protected by the MBTA should be minimized by the following procedures:

Non-breeding season: Approximately September 1 to January 31

WRA recommends that initial work be conducted in the non-breeding season, defined as September 1 to January 31. During this period breeding is not occurring and surveys are not required. However, if nesting birds are encountered during work activities in the non-breeding season, disturbance activities within a minimum of 50 feet of the nest should be postponed until the nest is abandoned or young birds have fledged.

Breeding season: Approximately February 1 to August 31

Between February 1 and August 31, it is recommended that pre-construction breeding bird surveys be conducted by a qualified biologist prior to and within 10 days of any initial ground disturbance activities. Surveys should be conducted within all suitable nesting habitat within 250 feet of the grading activity. All active non-status passerine nests identified at that time should be protected by a 50-foot radius minimum exclusion zone. Active raptor or special status species' nests should be protected by a buffer with a minimum radius of 200 feet. CDFG recommends a minimum 500 foot exclusion buffer be established around active White-tailed Kite nests. Survey results are valid for 14 days from the survey date. Should ground disturbance commence later than 14 days from the survey date, surveys should be repeated. If no breeding birds are encountered then work may commence as planned.

Exclusion zone sizes may vary depending on habitat characteristics and species, and are generally larger for raptors and colonial nesting birds. Each exclusion zone would remain in place until the nest is abandoned or all young have fledged.

Once activities begin within the RPA area, work may occur continuously for several years. The measures mentioned above should be appropriate for avoiding impacts to breeding bird species

in previously undisturbed or infrequently disturbed areas. In areas where work is ongoing, bird species are not expected to breed, and therefore, repeat surveys are not necessary.

Large trees or dense brush adjacent to ongoing work areas may provide suitable habitat to urban-adapted bird species protected by the MBTA. Removal of such large trees or dense brush within the breeding bird season warrant pre-construction breeding bird surveys as described above.

6.3 Roosting Bats

Although the majority of the RPA Area does not provide suitable roosting habitat for bats, the contiguous oak woodlands along northern fringe of the RPA (Figure 6) may provide such habitat. To avoid impacts to roosting bats within the RPA Area, WRA recommends the following procedures be implemented prior to work activities.

Non-roosting Season: Approximately September 1 to October 31

WRA recommends that any initial work along the northern RPA Area boundary be conducted during the non-roosting season. During this period, no preconstruction emergence surveys are required. If evidence of roosting is observed during work activities, consultation with a qualified bat biologist to determine an appropriate exclusion buffer is recommended.

Hibernation Season: Approximately November 1 to March 31

WRA recommends that work within 100 feet of the northern RPA Area boundary not be conducted during the hibernation season. During this time, emergence surveys are not effective at determining bat presence due to suppressed flight and foraging activities. However if a qualified bat biologist determines that a given area does not provide suitable hibernating conditions for bats and therefore they are unlikely to be present in the area, then work may commence as planned.

Maternity Roosting Season: Approximately April 1 to August 31

WRA recommends night-time evening emergence surveys and/or internal searches within large tree cavities to determine presence/absence of bat maternity roosts along the northern portion of the RPA Area boundary. All active roosts identified during surveys should be protected by a buffer to be determined by a qualified bat biologist. The buffer will be determined by the type of bat observed, topography, slope, aspect, surrounding vegetation, sensitivity of roost, type of potential disturbance, etc. Each exclusion zone would remain in place until the end of the maternity roosting season. If no active roosts are identified then a may commence as planned. Survey results are valid for 30 days from the survey date. Should work commence later than 30 days from the survey date, surveys should be repeated.

Operations may continue for up to many years. Surveys do not need to be repeated annually unless additional clearing of potential roosting or hibernating habitat may occur outside of the non-roosting season.

Consultation with CDFG may be warranted to determine appropriate mitigation measures if roosts are disturbed or destroyed.

7.0 REFERENCES

- Barry, S. J. and H. B. Shaffer. 1994. The status of the California Tiger Salamander (*Ambystoma californiense*) at Lagunita: a 50-year update. *Journal of Herpetology* 28:159-164.
- California Department of Fish and Game (CDFG). September 2008. Natural Diversity Database, Wildlife and Habitat Data Analysis Branch. Sacramento, California.
- California Department of Fish and Game (CDFG). September 2008. CalFish Cooperative Program, Wildlife and Habitat Data Analysis Branch and NCNCR Information Services Branch. <http://www.calfish.org>
- California Native Plant Society (CNPS). 2008. Electronic Inventory of Rare and Endangered Vascular Plants of California. California Native Plant Society, Sacramento, California.
- California Native Plant Society (CNPS). June 2001. CNPS Botanical Survey Guidelines.
- Dunk, J. R. 1995. White-tailed Kite (*Elanus leucurus*). In *The Birds of North America*, No. 178 (A. Poole and F. Gill, eds.). The Academy of Natural Sciences, Philadelphia, and The American Ornithologists' Union, Washington, D.C.
- Environmental Laboratory. 1987. Corps of Engineers Wetlands Delineation Manual. Department of the Army, Waterways Experiment Station, Vicksburg, Mississippi 39180-0631.
- Hickman, J.C. (ed.) 1993. *The Jepson manual: higher plants of California*. University of California Press.
- Holland, R. F. 1986. Preliminary Descriptions of the Terrestrial Natural Communities of California. Prepared for the California Department of Fish and Game, Sacramento, California.
- Holland, D. C., M. P. Hayes, and E. McMillan. 1990. Late summer movement and mass mortality in the California Tiger Salamander (*Ambystoma californiense*). *Southwestern Naturalist* 35:217-220.
- Jennings, M. R. 2006a. 2006 Biological monitoring of California Red-legged Frog (*Rana draytonii*) for sediment removal at the Hanson Permanente Cement Facility, Cupertino, California. Letter report to The Huffman-Broadway Group, San Rafael, California dated November 26, 2006. 1 p.
- Jennings, M. R. 2006b. 2006 California Red-legged Frog (*Rana draytonii*) surveys at the Hanson Permanente Cement Facility, Cupertino, California. Final report to The Huffman-Broadway Group, San Rafael, California dated December 30, 2006. 7 pp.
- Jennings, M. R. 2007. 2007 California Red-legged Frog (*Rana draytonii*) surveys at the Hanson Permanente Cement Facility, Cupertino, California. Final report to The Huffman-Broadway Group, San Rafael, California dated August 6, 2007. 7 pp.
- Jennings, M. R. 2008a. 2008 California Red-legged Frog (*Rana draytonii*) one night survey at the Hanson Permanente Cement Facility, Cupertino, California. Final report to The Huffman-Broadway Group, San Rafael, California dated August 21, 2008. 2 pp.

- Jennings, M. R. 2008b. 2007 Biological monitoring of California Red-legged Frog (*Rana draytonii*) for sediment removal at the Hanson Permanente Cement Facility, Cupertino, California. Letter report to The Huffman-Broadway Group, San Rafael, California dated August 31, 2008. 1 p.
- Jennings, M. R., and M. P. Hayes. 1994. Amphibian and reptile species of special concern in California. Final Report to the California Department of Fish and Game, Inland Fisheries Division, Rancho Cordova, CA. 225 pp.
- Jennings, Mark R. 2004. An Annotated Check List of Amphibians and Reptile Species of California and Adjacent Waters. Third, revised edition. California Department of Fish and Game.
- Loredo, I., D. Van Vuren, and M. L. Morrison. 1996. Habitat use and migration behavior of the California Tiger Salamander. *Journal of Herpetology* 30:282-285.
- Loredo-Prendeville, I. 1995. Reproductive ecology, microhabitat use, and migration behavior of the California Tiger Salamander. Unpublished M.S. Thesis, University of California, Davis.
- Matocq, M. 2003. Dusky-footed Woodrats (*Neotoma fuscipes*) at Hastings: A Research Tradition. Hastings Natural History Reservation.
<http://www.hastingsreserve.org/Woodrats/DFwoodrats.html>
- Nelson, James R. 1987. Rare Plant Surveys: Techniques for Impact Assessment. From Proceedings of a California Conference on the Conservation and Management of Rare and Endangered Plants, Sacramento, California, November 1986. California Native Plant Society Publication.
- Natural Resources Conservation Service (NRCS). 2002. Field Indicators of Hydric Soils in the United States, version 5.0. G.W. Hurt, P.M. Whited, eds. USDA, NRCS in cooperation with the National Technical Committee for Hydric Soils, Fort Worth, TX.
- Reed, Jr., Porter B. 1988. National List of Plant Species That Occur in Wetlands: National Summary. U.S. Fish & Wildlife Service. Biol. Rep. 88 (24). 244 pp.
- Shaffer, H. B., and R. Fisher. 1991. Final report to the California Department of Fish and Game; California Tiger Salamander surveys, 1990-Contract (FG 9422). California Department of Fish and Game, Inland Fisheries Division, Rancho Cordova, California.
- Stebbins, R.C. 2003. A Field Guide to Western Reptiles and Amphibians, 3rd Edition. The Peterson Field Guide Series, Houghton Mifflin Company, New York.
- Trenham, P. C. 2001. Terrestrial habitat use by adult California Tiger Salamanders. *Journal of Herpetology* 35:343-346.
- Trenham, P. C., and H. B. Shaffer. 2005. Amphibian upland habitat use and its consequences for population viability. *Ecological Applications* Vol. 15: 10 pp.
- Tucker, S.C. and B.D. Ryan. 2008. Costancea 84: Revised Catalog of Lichens, Lichenicoles, and Allied Fungi in California (<http://ucjeps.berkeley.edu/costancea/84/>). Accessed on 10-10-08

- U.S. Army Corps of Engineers (Corps). 2005. Regulatory Guidance Letter No. 05-05. Ordinary High Water Mark Identification. December 7.
- U.S. Department of Agriculture, Soil Conservation Service. 1958. Soil Survey of Santa Clara Area, California. In cooperation with the University of California Agricultural Experiment Station.
- U.S. Fish and Wildlife Service (USFWS). 2000. Endangered and threatened wildlife and plants; final determination of endangered status for the Santa Barbara County Distinct Vertebrate Population Segment of the California Tiger Salamander (*Ambystoma californiense*).
- U.S. Fish and Wildlife Service (USFWS). 2007. Species Account: California Tiger Salamander (*Ambystoma californiense*). Sacramento Fish and Wildlife Office. Sacramento, California 95825. Last updated December 7, 2007.
- U.S. Fish and Wildlife Service (USFWS). 2009. Quadrangle Species Lists, Sacramento Fish and Wildlife Service. February.
- Vickery, Peter D. 1996. Grasshopper Sparrow (*Ammodramus savannarum*), The Birds of North America Online (A. Poole, Ed.). Ithaca: Cornell Lab of Ornithology; Retrieved from the Birds of North America Online: <http://bna.birds.cornell.edu/bna/species/239>
- WRA, Inc. (WRA). 2009. Delineation of Potential Clean Water Act Section 404 Jurisdiction at Permanente Quarry - East Materials Storage Area. Prepared for Permanente Quarry.
- Zeiner, D. C., W. F. Laudenslayer, Jr., K. E. Mayer, and M. White. 1990. California's Wildlife, Volume I-III: Amphibians and Reptiles, Birds, Mammals. California Statewide Wildlife Habitat Relationships System, California Department of Fish and Game, Sacramento.

APPENDIX A
POTENTIAL FOR SPECIAL STATUS SPECIES
TO OCCUR IN THE RPA AREA

Appendix A. Potential for Special Status Plant and Wildlife Species to Occur in the Study Area. List compiled from the California Department of Fish and Game (CDFG) Natural Diversity Database (January 2009), U.S. Fish and Wildlife Service (USFWS) Species Lists, and California Native Plant Society (CNPS) Electronic Inventory search of the Cupertino, Castle Rock Ridge, Big Basin, Milpitas, San Jose West, Los Gatos, Mountain View, Palo Alto, and Mindego Hill USGS 7.5' quadrangles, and a review of other CDFG lists and publications (Jennings and Hayes 1994, Zeiner et al. 1990).

SPECIES	STATUS	HABITAT	POTENTIAL FOR OCCURRENCE	RECOMMENDATIONS
Mammals				
Salt-marsh Wandering Shrew <i>Sorex vagrans halicoetes</i>	SSC	Salt marshes of the south arm of San Francisco Bay. Medium high marsh 6 to 8 feet above sea level where abundant driftwood is scattered among <i>Salicornia</i> .	No Potential. No suitable tidal marsh habitat is available in the Study Area or vicinity. The nearest documented occurrence of this species is 8.7 miles northeast of the Study Area (CNDDDB 2009).	No further actions are recommended for this species.
Pallid Bat <i>Antrozous pallidus</i>	SSC, WBWG High Priority	Found in deserts, grasslands, shrublands, woodlands, and forests. Most common in open, dry habitats with rocky areas for roosting. Roosts must protect bats from high temperatures. Sensitive to disturbance of roosting sites.	Moderate Potential. Although much of the Study Area is unvegetated, a few stands of mature trees are present. Disturbance associated with quarry operations may preclude the presence of this species. Suitable foraging habitat is present for this species. The nearest documented occurrence of this species is 5.0 miles north of the Study Area (CNDDDB 2008).	Vegetation removal should not be conducted between November through March to avoid impacting hibernating bat roosts. Removal of vegetation should be limited to the months of September and October when bats are not hibernating or breeding. If vegetation removal is necessary between April and August, night time emergence surveys are recommended.

SPECIES	STATUS *	HABITAT	POTENTIAL FOR OCCURRENCE	RECOMMENDATIONS
Western Red Bat <i>Lasiurus blossevillii</i>	SSC	Roosts primarily in trees, 2-40 ft above ground, from sea level up through mixed conifer forests. Prefers habitat edges & mosaics with trees that are protected from above & open below with open areas for foraging.	Unlikely. Much of the Study Area is unvegetated. A few trees are present, although constant disturbance associated with quarry operations likely preclude the presence of this species. Suitable foraging habitat for this species is not present within the Study Area. There are no known occurrences within 5 miles of the Study Area (CNDDDB 2008).	No further actions are recommended for this species.
Townsend's Big-eared Bat <i>Corynorhinus townsendii</i>	SSC, WBWG High Priority	Live in a wide variety of habitats but most common in mesic sites. Day roosts highly associated with caves and mines. Need appropriate roosting, maternity, and hibernacula sites free from human disturbance.	Unlikely. The Study Area contains no suitable roosting or foraging habitat for this species. There are no documented occurrences within 5 miles of the Study Area (CNDDDB 2008).	No further actions are recommended for this species.
Saltmarsh Harvest Mouse <i>Reithrodontomys raviventris</i>	FE, SE, CFP	Found only in the saline emergent wetlands of San Francisco bay and its tributaries. Primary habitat is pickleweed-dominated, saline emergent marshes. Requires adjacent, upland areas for escape from high tides. Does not burrow.	No Potential. No suitable tidal marsh habitat is available in the Study Area or vicinity. There are no documented occurrences within 5 miles of the Study Area (CNDDDB 2008).	No further actions are recommended for this species.
San Francisco Dusky-footed Woodrat <i>Neotoma fuscipes annectens</i>	SSC	Forest habitats of moderate canopy & moderate to dense understory. May prefer chaparral & redwood habitats. Constructs nests of shredded grass, leaves & other material. May be limited by availability of nest-building materials.	Present. Woodrat nests were documented and locations recorded within the Study Area during the site assessment (see Figure 6)	Stick nests within the Study Area should be dismantled by hand and relocate the materials to an area in or adjacent to the Project site that will not be directly impacted.

SPECIES	STATUS *	HABITAT	POTENTIAL FOR OCCURRENCE	RECOMMENDATIONS
San Joaquin Kit Fox <i>Vulpes macrotis mutica</i>	FE	San Joaquin Kit Fox occupies annual grasslands or grassy open stages with scattered shrubby vegetation. This species needs loose-textured sandy soils for burrowing and suitable prey base.	Unlikely. Poor habitat for San Joaquin Kit Fox is present within the Study Area. The nearest documented occurrence of this species is in excess of 20 miles east southeast of the Study Area (CNDDDB 2008).	No further actions are recommended for this species.
American Badger <i>Taxidea taxus</i>	SSC	Most abundant in drier open stages of most shrub, forest, and herbaceous habitats with friable soils. Requires friable soils and open, uncultivated ground. Preys on burrowing rodents.	Unlikely. Large portions of the Study Area is disturbed with densely packed rocky substrates. Suitable habitat patches are small, highly fragmented and subject to quarry disturbance. The nearest documented occurrence of this species is 9.4 miles northwest of the Study Area.	No further actions are recommended for this species.
Birds				
Northern Harrier <i>Circus cyaneus</i>	SSC	Nests and forages in open meadows, savannah and grassland habitats, often in association with wetlands. Nests on ground in shrubby vegetation; nest built of a large mound of sticks in wet areas. May also occur in upland desert steeps; they generally avoid forested and mountainous areas.	Unlikely. No grassland habitat of suitable size is present within the Study Area. The nearest documented occurrence of nesting harriers is 11.3 miles north of the Study Area (CNDDDB 2008).	No further actions are recommended for this species.
Golden Eagle <i>Aquila chrysaetos</i>	CFP, BCC, SLC	Nests and forages along rolling foothills, mountain areas, sage-juniper flats and deserts. Cliff-walled canyons provide nesting habitat in most parts of their range, they are also known to nest in large trees in open areas.	Unlikely. Within the Study Area there are no large trees within open areas that are not subject to disturbance from quarry operations. Additionally there are no unvegetated cliffs that are suitable to support nesting Golden Eagles. The nearest documented occurrence of nesting harriers is 15.5 miles northeast of the Study Area (CNDDDB 2008).	No further actions are recommended for this species.

SPECIES	STATUS *	HABITAT	POTENTIAL FOR OCCURRENCE	RECOMMENDATIONS
White-tailed Kite <i>Elanus leucurus</i>	CFP	Year-long resident of coastal and valley lowlands; rarely found away from agricultural areas. Preys on small diurnal mammals and occasional birds, insects, reptiles, and amphibians.	Present. White-tailed Kites have been observed foraging and exhibiting pair bonding behavior within the Study Area. This species may breed within or adjacent to the Study Area. The nearest documented occurrence of nesting kites is 1.7 miles east of the Study Area (CNDDDB 2008).	If brush and vegetation removal occurs between February 1 and September 1, pre-construction breeding bird surveys should be conducted in the vicinity and within 14 days of ground disturbance to avoid disturbance to active nests, eggs, and/or young.
American Peregrine Falcon <i>Falco peregrinus anatum</i>	FD, SE, BCC, CFP,	Prefers dry, open terrain, either level or hilly. Forages far afield, even to marshlands and ocean shores. Nests near wetlands, lakes, rivers, or other water; on cliffs, banks, dunes, mounds; also, human-made structures. Nest consists of a scrape on a depression or ledge in an open site.	Unlikely. No nesting habitat for Peregrine Falcons is present within the Study Area. This species was observed adjacent to the Study Area on July 10, 2008. The nearest documented occurrence of nesting Peregrine Falcons is 11.3 miles east of the Study Area (CNDDDB 2008).	No further actions are recommended for this species.
Black Rail <i>Laterallus jamaicensis coturniculus</i>	ST, CFP	Rarely seen resident of saline, brackish, and fresh water emergent wetlands of the San Francisco Bay area. Nests in dense stands of pickleweed.	No Potential. There is no suitable marsh habitat within the Study Area. There are no documented occurrences within 5.0 miles of the Study Area (CNDDDB 2008).	No further actions are recommended for this species.
California Clapper Rail <i>Rallus longirostris obsoletus</i>	FE, SE	Found in tidal salt marshes of the San Francisco Bay area. Requires mud flats for foraging and dense vegetation on higher ground for nesting.	No Potential. No suitable marsh habitat is available in the Study Area or vicinity. There are no documented occurrences within 5.0 miles of the Study Area (CNDDDB 2008).	No further actions are recommended for this species.

SPECIES	STATUS *	HABITAT	POTENTIAL FOR OCCURRENCE	RECOMMENDATIONS
Western Snowy Plover <i>Charadrius alexandrinus nivosus</i>	FT, CSC, BCC, RP	Federal listing applies only to the Pacific coastal population. Found on sandy beaches, salt pond levees and shores of large alkali lakes. Requires sandy, gravelly or friable soils for nesting.	No Potential. There is no sandy beach or alkali flat habitat within the Study Area. There are no documented occurrences within 5.0 miles of the Study Area (CNDDDB 2008).	No further actions are recommended for this species.
California Least Tern <i>Sterna (Sternula) antillarum browni</i>	FE, SE, CFP	Nests along the coast from San Francisco Bay south to northern Baja California. Breeding colonies in San Francisco Bay found in abandoned salt ponds and along estuarine shores. Colonial breeder on barren or sparsely vegetated, flat substrates near water.	No Potential. There is no sandy beach or salt pond habitat within the Study Area. There are no documented occurrences within 5.0 miles of the Study Area (CNDDDB 2008).	No further actions are recommended for this species.
Marbled Murrelet <i>Brachyramphus marmoratus</i>	FT, SE	Feeds near shore; nests inland along the Pacific coast from Eureka to the Oregon border, and from Half Moon Bay to Santa Cruz. Nests in old-growth redwood-dominated forests, up to six miles inland. Nests often built in Douglas-fir or redwood stands containing platform-like branches.	No Potential. There is no coastal old-growth redwood habitat within the Study Area. There are no documented occurrences within 5.0 miles of the Study Area (CNDDDB 2008).	No further actions are recommended for this species.
Long-eared Owl <i>Asio otus</i>	CSC	Nests in mature riparian bottomlands with willows and cottonwoods; also, belts of live oak paralleling stream courses. Require adjacent open land productive of mice and the presence of old nests of crows, hawks, or magpies for breeding.	Unlikely. Potentially suitable habitat is present adjacent to the Study Area, but nesting and foraging habitat are absent within the Study Area. This species may occasionally fly over the Study Area. The nearest documented occurrence of nesting Short-eared Owls is 4.2 miles west of the Study Area (CNDDDB 2008).	If brush and vegetation removal occurs between February 1 and September 1, pre-construction breeding bird surveys should be conducted in the vicinity and within 14 days of ground disturbance to avoid disturbance to active nests, eggs, and/or young.

SPECIES	STATUS *	HABITAT	POTENTIAL FOR OCCURRENCE	RECOMMENDATIONS
Burrowing Owl <i>Athene cunicularia</i>	CSC, BCC	Frequents open, dry annual or perennial grasslands and scrub habitats with low-growing vegetation, perches and abundant burrows. Preys upon insects, small mammals, reptiles, birds, and carrion. Subterranean nester; nests and roosts in old burrows of small mammals.	Unlikely. The Study Area is predominantly compacted dominated by steep, densely vegetated slopes and hardscape. These areas do not provide suitable habitat for this species. Some burrowing habitat is present within the active quarry along the railroad tracks where California Ground Squirrels have been observed. The nearest documented occurrence of breeding Burrowing Owls is 5.3 miles northeast of the Study Area (CNDDDB 2008).	No further actions are recommended for this species.
Olive-sided Flycatcher <i>Contopus cooperi</i>	SSC, BCC	Nesting habitats are mixed conifer, montane hardwood-conifer, douglas-fir, redwood, red fir & lodgepole pine. Most numerous in montane conifer forests where tall trees overlook canyons, meadows, lakes or other open terrain.	Unlikely. Nesting and foraging habitat within the Study area is marginal. A female Olive-sided Flycatcher was observed adjacent to the Study Area on April 22, 2008. There are no documented occurrences of this species recorded in CNDDDB (CNDDDB 2008).	No further actions are recommended for this species.
Loggerhead Shrike <i>Lanius ludovicianus</i>	SSC, BCC	Occurs in woodland, grassland, savannah, pinyon-juniper forest, desert, and scrub habitats. Prefers open areas with sparse shrubs, trees, posts, and other suitable perches which to forage for large insects. Nests are well-concealed above ground in densely-foliaged shrub or tree.	Moderate Potential. Marginal foraging and nesting habitat is present in the vegetated portions of the Study Area. This species is tolerant of human activities. There are no documented occurrences of this species within 5.0 miles of the Study Area (CNDDDB 2008).	If brush and vegetation removal occurs between February 1 and September 1, pre-construction breeding bird surveys should be conducted in the vicinity and within 14 days of ground disturbance to avoid disturbance to active nests, eggs, and/or young.

SPECIES	STATUS *	HABITAT	POTENTIAL FOR OCCURRENCE	RECOMMENDATIONS
Least Bell's Vireo <i>Vireo bellii pusillus</i>	FE, SE, BCC, SLC	This species is a Summer resident of Southern California whose range is extending northward. Nesting occurs in riparian areas in vicinity of water or in dry river bottoms. Nests placed along margins of bushes or on twigs projecting into pathways, usually willow, coyote brush or mesquite.	No Potential. The Study Area is outside the known distribution for this species. Additionally no suitable riparian habitat is present. The nearest documented occurrence of breeding Least Bell's Vireos is 37.5 miles southeast of the Study Area (CNDDDB 2008).	No further actions are recommended for this species.
Yellow Warbler <i>Dendroica petechia</i>	SSC	Riparian plant associations. Prefers willows, cottonwoods, aspens, sycamores, & alders for nesting & foraging. Also nests in montane shrubbery in open conifer forests.	Unlikley. Foraging and nesting habitat are absent from the Study Area. Yellow Warblers have been observed adjacent to Study Area by WRA Biologists. There are no documented occurrences of this species nesting within 5 miles of the Study Area (CNDDDB 2008).	No further actions are recommended for this species.
Saltmarsh Common Yellowthroat <i>Geothlypis trichas sinuosa</i>	SSC, BCC	Resident of the San Francisco Bay region in fresh and saltwater marshes. Frequents low, dense vegetation near water. Requires thick, continuous cover down to water surface for foraging, and tall grasses, tule patches, or willows for nesting.	Unlikely. No suitable nesting or foraging habitat is available in the Study Area. The nearest documented occurrence is 8.0 miles north of the Study Area (CNDDDB 2008).	No further actions are recommended for this species.
Grasshopper Sparrow <i>Ammodramus savannarum</i>	SSC	Favors native grasslands with a mix of grasses, forbs and scattered shrubs. This species is loosely colonial when nesting. Prefers dense grasslands on rolling hills, lowland plains, in valleys and on hillsides on lower mountain slopes.	High Potential. Suitable patchy grassland habitat is available for this species to nest within the Study Area. This species has been identified adjacent to the Study Area in similar habitats. There are no documented occurrences of this species nesting within 5 miles of the Study Area (CNDDDB 2008).	If brush and vegetation removal occurs between February 1 and September 1, pre-construction breeding bird surveys should be conducted in the vicinity and within 14 days of ground disturbance to avoid disturbance to active nests, eggs, and/or young.

SPECIES	STATUS *	HABITAT	POTENTIAL FOR OCCURRENCE	RECOMMENDATIONS
Alameda Song Sparrow <i>Melospiza melodia pusillula</i>	SSC, BCC	Resident of salt marshes bordering south arm of San Francisco Bay. Inhabits <i>Salicornia</i> marshes; nests low in <i>Grindelia</i> bushes (high enough to escape high tides) and in <i>Salicornia</i> .	No Potential. No suitable marsh habitat is available in the Study Area. There are no documented occurrences of this species within 5.0 miles of the Study Area (CNDDDB 2008).	No further actions are recommended for this species.
Tricolored Blackbird <i>Agelaius tricolor</i>	SSC, BCC, RP	A highly colonial species most numerous in the Central Valley and vicinity. Usually nests over or near freshwater in dense cattails, tules, or thickets of willow, blackberry, wild rose or other tall herbs. Requires breeding habitat sufficient to support 30 nesting pairs.	No Potential. No suitable marsh habitat is present within the Study Area. The nearest documented breeding colony is 14.0 miles northeast of the Study Area (CNDDDB 2008).	No further actions are recommended for this species.
Reptiles and Amphibians				
Western Pond Turtle <i>Emys (Clemmys) marmorata</i>	SSC, SLC	Occurs in perennial ponds, lakes, rivers and streams with suitable basking habitat (mud banks, mats of floating vegetation, partially submerged logs) and submerged shelter.	No Potential. No ponds or suitable streams are present within the Study Area. Detention basins may provide marginal habitat for Western Pond Turtles. The nearest documented occurrence is 8.5 miles southeast of the Study Area (CNDDDB 2008).	No further actions are recommended for this species.
San Francisco Garter Snake <i>Thamnophis sirtalis tetrataenia</i>	FE, SE	Vicinity of freshwater marshes, ponds and slow moving streams in San Mateo County and northern Santa Cruz County. Prefers dense cover & water depths of at least one foot. Upland areas near water are also very important.	No Potential. Santa Clara County is outside the accepted range of this subspecies. There is no suitable marsh or pond habitat within the Study Area. The nearest documented occurrence is 8.0 miles west of the Study Area (USFWS 2006).	No further actions are recommended for this species.

SPECIES	STATUS *	HABITAT	POTENTIAL FOR OCCURRENCE	RECOMMENDATIONS
Alameda Whipsnake <i>Masticophis lateralis euryxanthus</i>	FT	Alameda Whipsnake is restricted to valley-foothill hardwood habitat of the Coast Ranges between Monterey and San Francisco Bay. They inhabit south-facing slopes and ravines where shrubs form a vegetative mosaic with oak trees and grasses.	Unlikely. There are no known occurrences of Alameda Whipsnake in Santa Clara County. Much of the Study Area is highly disturbed. Patches of highly fragmented, marginal habitat are present, however the Study Area is outside of the accepted distribution of this sub species.	No further actions are recommended for this species.
California Tiger Salamander <i>Ambystoma californiense</i>	FT, SSC, SLC	Inhabits annual grassland habitats with mammal burrows. Seasonal ponds and vernal pools are crucial to breeding.	Unlikely. No suitable breeding habitat is present within the Study Area. Suitable upland estivation habitat with small mammal burrows is limited within the Study Area or adjacent areas, however, aquatic habitats are of poor quality. Isolated sections of Permanente Creek adjacent to the Study Area may provide some aquatic habitat, however, poor water quality and annual disturbance in quarry detention ponds are likely to preclude breeding adjacent to the Study Area. The last known occurrence in Permanente Creek drainage system was in 1893 (CNDDDB 2008) and was likely misidentified.	No further actions are recommended for this species.

SPECIES	STATUS *	HABITAT	POTENTIAL FOR OCCURRENCE	RECOMMENDATIONS
Foothill Yellow-legged Frog <i>Rana boylei</i>	SSC, SLC	FYLF occurs in partly-shaded, shallow streams and riffles with a rocky substrate in a variety of habitats. They need at least some cobble-sized substrate for egg-laying and at least 15 weeks to metamorphose.	Unlikely. Drainages within the Study Area are small, isolated, steep, and seasonal. They likely do not hold water long enough for FYLF to breed. Furthermore, FYLF have not been observed in the vicinity of the Study Area despite focused amphibian surveys. The nearest documented occurrence of this species is 7.8 miles west-southwest of the Study Area (CNDDDB 2008)	No further actions are recommended for this species.
California Red-legged Frog <i>Rana aurora draytonii</i>	FT, SSC, SLC	Associated with quiet perennial to intermittent ponds, stream pools and wetlands. Prefers shorelines with extensive vegetation. Documented to disperse through upland habitats after rains.	Unlikely. CRLF are documented to occur and breed adjacent to the Study Area. There is no suitable aquatic habitat within the Study Area that ponds for sufficient duration to support breeding CRLF. Developed quarry roads within and surrounding the Study Area are likely a barrier to dispersing CRLF.	Work should take place in excess of 300 feet from occupied CRLF aquatic habitats.
Fishes				
Green Sturgeon <i>Acipenser medirostris</i>	FT, NMFS	Green Sturgeon spawn in the Sacramento and Klamath Rivers. Requires water temperatures between 8-14 degrees celsius to spawn. Preferred spawning substrate is large cobble, but can range from clean sand to bedrock.	No Potential. Study Area is outside of the present distribution range of Green Sturgeon (NOAA 2008). No streams within the Study area are hydrologically connected to San Francisco Bay.	No further actions are recommended for this species.

SPECIES	STATUS *	HABITAT	POTENTIAL FOR OCCURRENCE	RECOMMENDATIONS
Pacific Lamprey <i>Lampetra tridentata</i>	SLC	Found in Pacific coast streams north of San Luis Obispo County, however regularly runs in the Santa Clara River. This species prefers high velocity, gravel bottomed areas for spawning with water temps between 12-18 degrees Celsius. Juveniles need soft sand or mud.	No Potential. No streams within the Study area are hydrologically connected to San Francisco Bay. There are no documented occurrences of this species in CNDDDB (2008).	No further actions are recommended for this species.
Tidewater Goby <i>Eucyclogobius newberryi</i>	FE	Tidewater Gobies occur in brackish water habitats along the California Coast from Agua Hedionda Lagoon in San Diego County to the mouth of the Smith River. They are found in shallow lagoons and lower stream reaches. They require fairly still but not stagnant water and high oxygen levels.	No Potential. No streams within the Study area are hydrologically connected to San Francisco Bay. The Study Area is outside of the present distribution range of Tidewater Goby (NOAA 2008).	No further actions are recommended for this species.
Delta Smelt <i>Hypomesus transpacificus</i>	FT	Delta Smelt are found in the Sacramento - San Joaquin Delta. They seasonally occur in Suisun Bay, Carquinez Strait and San Pablo Bay. This species most often occurs at salinities less than 2 ppt and is seldom found at salinities greater than 10 ppt.	No Potential. No streams within the Study area are hydrologically connected to San Francisco Bay. The Study Area is outside of the present distribution range of Delta Smelt (NOAA 2008).	No further actions are recommended for this species.

SPECIES	STATUS *	HABITAT	POTENTIAL FOR OCCURRENCE	RECOMMENDATIONS
Chinook Salmon - Central Valley fall run ESU <i>Oncorhynchus</i> <i>tshawytscha</i>	SSC, SLC	Central Valley fall run Chinook Salmon include all naturally spawned populations of fall-run Chinook salmon in the Sacramento River and its tributaries in California, including the Feather River, as well as the Feather River Hatchery spring-run Chinook program. This species requires clean, cold water over gravel beds with water temperatures between 6 and 14 degrees Celsius for spawning.	No Potential. No streams within the Study area are hydrologically connected to San Francisco Bay. The Study Area is outside of the present distribution range of Central Valley fall run Chinook Salmon (NOAA 2008).	No further actions are recommended for this species.
Chinook Salmon - Central Valley spring run ESU <i>Oncorhynchus</i> <i>tshawytscha</i>	FT, NMFS	Central Valley spring run Chinook Salmon include all naturally spawned populations of spring-run Chinook salmon in the Sacramento River and its tributaries in California, including the Feather River, as well as the Feather River Hatchery spring-run Chinook program. This species requires clean, cold water over gravel beds with water temperatures between 6 and 14 degrees Celsius for spawning.	No Potential. No streams within the Study area are hydrologically connected to San Francisco Bay. The Study Area is outside of the present distribution range of Central Valley spring run Chinook Salmon (NOAA 2008).	No further actions are recommended for this species.
Chinook Salmon - Sacramento River winter run ESU <i>Oncorhynchus</i> <i>tshawytscha</i>	FE, NMFS	Winter run Chinook Salmon occur in the Sacramento River below Keswick Dam. They spawn in the Sacramento River but not in tributary streams. This species requires clean, cold water over gravel beds with water temperatures between 6 and 14 degrees Celsius for spawning.	No Potential. No streams within the Study area are hydrologically connected to San Francisco Bay. The Study Area is outside of the present distribution range of Sacramento River winter run Chinook Salmon (NOAA 2008).	No further actions are recommended for this species.

SPECIES	STATUS *	HABITAT	POTENTIAL FOR OCCURRENCE	RECOMMENDATIONS
Coho Salmon - Central California Coast ESU <i>Oncorhynchus kisutch</i>	FE, NMFS	Occurs inland and in coastal marine waters. Requires beds of loose, silt-free, coarse gravel for spawning. Also needs cover, cool water and sufficient dissolved oxygen.	No Potential. No streams within the Study area are hydrologically connected to San Francisco Bay. The Study Area is outside of the present distribution range of central California Coast Coho Salmon (NOAA 2008).	No further actions are recommended for this species.
Steelhead - Central Valley ESU <i>Oncorhynchus mykiss</i>	FT, NMFS	Populations in the Sacramento and San Joaquin rivers and their tributaries. Adults migrate upstream to spawn in cool, clear, well-oxygenated streams. Juveniles remain in fresh water for 1 or more years before migrating downstream to the ocean.	No Potential. No streams within the Study area are hydrologically connected to San Francisco Bay. The Study Area is outside of the present distribution range of Central Valley Steelhead (NOAA 2008)	No further actions are recommended for this species.
Steelhead - central CA coast ESU <i>Oncorhynchus mykiss</i>	FT, NMFS	Occurs from the Russian River south to Soquel Creek and Pajaro River. Also in San Francisco and San Pablo Bay Basins. Adults migrate upstream to spawn in cool, clear, well-oxygenated streams. Juveniles remain in fresh water for 1 or more years before migrating downstream to the ocean.	No Potential. No streams within the Study area are hydrologically connected to San Francisco Bay.	No further actions are recommended for this species.
Invertebrates				
Bay checkerspot butterfly <i>Euphydryas editha bayensis</i>	FT, SSI, RP	Restricted to native grasslands on outcrops of serpentine soil in the vicinity of San Francisco Bay and San Jose. <i>Plantago erecta</i> is the primary host plant; <i>Orthocarpus densiflorus</i> and <i>O. purpurascens</i> are the secondary host plants.	No Potential. Suitable serpentine soil habitat is not present in the Study Area. There are no documented occurrences within 5 miles of the Study Area (CNDDDB 2008).	No further actions are recommended for this species.

SPECIES	STATUS *	HABITAT	POTENTIAL FOR OCCURRENCE	RECOMMENDATIONS
San Bruno elfin butterfly <i>Incisalia mossii bayensis</i>	FE	Occurs on coastal, mountainous areas with grassy ground cover, mainly in the vicinity of San Bruno Mountain in San Mateo County. Colonies are located on steep, north-facing slopes within the fog belt. Larval host plant is <i>Sedum spathulifolium</i> .	No Potential. The Study Area is outside the known range for this species. There are no documented occurrences within 5 miles of the Study Area (CNDDDB 2008).	No further actions are recommended for this species.
unsilvered fritillary butterfly <i>Speyeria adiaste adiaste</i>	SSI	Restricted range: Santa Clara north to San Mateo County; east to north Los Angeles County and Kern County. Larval host plant is <i>Viola quercetorum</i> . Adults utilize openings in redwood and coniferous forests, oak woodlands, and chaparral habitats.	Unlikely. The host plant of this species has not been identified within the Study Area and/or adjacent areas. The nearest documented occurrence is 3.9 miles southwest of the Study Area (CNDDDB 2008).	No further actions are recommended for this species.
Zayante band-winged grasshopper <i>Trimerotropis infantilis</i>	FE	Isolated sandstone deposits in the Santa Cruz Mountains (the Zayante Sand Hills Ecosystem) mostly on sand parkland habitat but also in areas with well-developed ground cover & in sparse chaparral with grass.	No Potential. The Study Area does not contain suitable soils to support this species and is outside the accepted range of this species. The nearest documented occurrence is 10.4 miles south-southeast of the Study Area (CNDDDB 2008).	No further actions are recommended for this species.
conservancy fairy shrimp <i>Branchinecta conservatio</i>	FE	This species is endemic to the grasslands of the northern two-thirds of the Central Valley. They are found in large, turbid pools and inhabit pools located in swales formed by old, braided alluvium. Occupied pools remain inundated until June.	No Potential. The Study Area is outside the known range for this species. There are no documented occurrences within 5 miles of the Study Area (CNDDDB 2008).	No further actions are recommended for this species.

SPECIES	STATUS *	HABITAT	POTENTIAL FOR OCCURRENCE	RECOMMENDATIONS
vernal pool tadpole shrimp <i>Lepidurus packardii</i>	FE, SSI, RP	Inhabits vernal pools and swales in the Sacramento Valley and San Francisco Bay Area containing clear to highly turbid water. Pools commonly found in grass bottomed swales of unplowed grasslands. Some pools are mud-bottomed and highly turbid.	No Potential. There are no vernal pools or other seasonal wetlands in the Study Area. There are no documented occurrences within 5 miles of the Study Area (CNDDDB 2008).	No further actions are recommended for this species.
Plants				
San Mateo thorn mint <i>Acanthomintha duttonii</i>	List 1B, FE, SE	Occurs in chaparral and valley and foothill grassland on serpentinite soils. 5-300 meters. Blooms April-June.	No Potential. The Study Area lacks suitable serpentinite soils.	No further actions are recommended for this species.
Franciscan onion <i>Allium peninsulare</i> var. <i>franciscanum</i>	List 1B	Occurs in cismontane woodland, valley and foothill grassland on clay, volcanic, and often serpentinite soils. 52 - 300 meters. Blooms May-June.	No Potential. The Study Area lacks suitable clay, volcanic, and serpentinite soils.	No further actions are recommended for this species.
Sharsmith's onion <i>Allium sharsmithiae</i>	List 1B	Occurs in chaparral and cismontane woodland on rocky, serpentinite soils. 400-1200 meters. Blooms March-May.	No Potential. The Study Area lacks suitable serpentinite soils.	No further actions are recommended for this species.
bent-flowered fiddleneck <i>Amsinckia lunaris</i>	List 1B	Occurs in coastal bluff scrub, cismontane woodland and valley and foothill grassland. 3-500 meters. Blooms March-June.	Unlikely. The majority of the grassland habitat in the Study Area is significantly disturbed. The nearest known occurrence >15 miles.	No further actions are recommended for this species.
slender silver moss <i>Anomobryum julaceum</i>	List 2	Occurs in broadleaved upland forest, lower montane coniferous forest, and North Coast coniferous forest on damp rock and soils on outcrops and roadcuts. 100-1000 meters.	No Potential. The Study Area lacks suitable forested habitats and the only known occurrence of this species in the vicinity of the Study Area is uncertain (CDFG 2008).	No further actions are recommended for this species.

SPECIES	STATUS *	HABITAT	POTENTIAL FOR OCCURRENCE	RECOMMENDATIONS
Santa Cruz Mountains manzanita <i>Arctostaphylos andersonii</i>	List 1B	Occurs in openings and edges of broadleaved upland forest, chaparral, and North Coast coniferous forest. 60-730 meters. Blooms November-April.	Unlikely. Although chaparral habitat is present in the Study Area, this species is typically found on the edge of Redwood Forests.	No further actions are recommended for this species.
Schreiber's manzanita <i>Arctostaphylos glutinosa</i>	List 1B	Occurs in closed-cone coniferous forest, and chaparral on diatomaceous shale. 170-685 meters. Blooms November-April.	No Potential. Chaparral habitat is present in the Study Area; however, this species occurs on shale soils not present in the Study Area. Additionally, this species is known from the west side of the Santa Cruz Mountains.	No further actions are recommended for this species.
Pajaro manzanita <i>Arctostaphylos pajaroensis</i>	List 1B	Occurs in chaparral on sandy soils. 30-760 meters. Blooms December-March.	No Potential. The Study Area lacks suitable chaparral habitat on sandy soils.	No further actions are recommended for this species.
King's Mountain manzanita <i>Arctostaphylos regismontana</i>	List 1B	Occurs in broadleaved upland forest, chaparral and North Coast coniferous forest on granitic or sandstone substrates. 305-730 meters. Blooms January-April.	No Potential. The Study Area lacks suitable forest or chaparral habitat on granitic or sandstone substrates.	No further actions are recommended for this species.
Bonny Doon manzanita <i>Arctostaphylos silvicola</i>	List 1B	Occurs in closed-cone coniferous forest, chaparral and lower montane coniferous forest on inland marine-derived sandy soils. 120-600 meters. Blooms February-March.	No Potential. The Study Area lacks suitable forest and chaparral habitats on inland marine-derived sandy soils.	No further actions are recommended for this species.
alkali milk-vetch <i>Astragalus tener</i> <i>var. tener</i>	List 1B	Alkali playa, valley and foothill grassland, vernal pools. Low ground, alkali flats, and flooded lands. 1-170m. Blooms March-June.	No Potential. The Study Area lacks suitable alkali flooded habitats.	No further actions are recommended for this species.

SPECIES	STATUS *	HABITAT	POTENTIAL FOR OCCURRENCE	RECOMMENDATIONS
brittlescale <i>Atriplex depressa</i>	List 1B	Occurs in chenopod scrub, meadows and seeps, playas, valley and foothill grassland and vernal pools, on alkaline clay soils. 1-320 meters. Blooms May-October.	No Potential. The Study Area lacks suitable alkaline clay soils.	No further actions are recommended for this species.
San Joaquin spearscale <i>Atriplex joaquiniana</i>	List 1B	Chenopod scrub, alkali meadow, valley and foothill grassland. In seasonal alkali wetlands or alkali sink scrub with <i>Distichlis spicata</i> , <i>Frankenia salina</i> , etc. 1-250m. Blooms April-October.	No Potential. The Study Area lacks suitable alkali wetlands.	No further actions are recommended for this species.
big-scale balsamroot <i>Balsamorhiza macrolepis</i> var. <i>macrolepis</i>	List 1B	Occurs in chaparral, cismontane woodland and valley and foothill grassland, sometimes on serpentinite soils. 90-1400 meters. Blooms March-June.	Moderate. Suitable chaparral and woodland habitat on non-serpentinite soils is present in the Study Area.	No further actions are recommended for this species. This species was not observed during rare plant surveys.
round-leaved filaree <i>California macrophylla</i>	List 1B	Occurs in cismontane woodland and valley and foothill grassland on clay soils. 15-1200 meters. Blooms March-May.	No Potential. The Study Area lacks suitable clay soils.	No further actions are recommended for this species.
Santa Cruz cypress <i>Callitropsis abramsiana</i> (<i>Cupressus abramsiana</i>)	List 1B, FE, SE	Occurs within closed-cone coniferous forest, chaparral, and lower-montane coniferous forest. Restricted to the Santa Cruz mountains, usually found with <i>Pinus attenuata</i> . 280-800 meters.	No Potential. The Study Area hosts very few coniferous species. Additionally, this species is known from the ridge-line and west side of the Santa Cruz Mountains.	No further actions are recommended for this species.
Santa Cruz Mountains pussypaws <i>Calyptridium parryi</i> var. <i>hesseae</i>	List 3	Occurs in chaparral and cismontane woodland. 305-1115 meters. Blooms May-July.	Unlikely. Although suitable chaparral and woodland habitat is present in the Study Area, it is slightly below the observed elevation range.	No further actions are recommended for this species.

SPECIES	STATUS *	HABITAT	POTENTIAL FOR OCCURRENCE	RECOMMENDATIONS
chaparral harebell <i>Campanula exigua</i>	List 1B	Occurs in chaparral, usually on rocky, serpentinite soils. 275-1250 meters. Blooms May-June.	No Potential. The Study Area lacks suitable serpentinite soils.	No further actions are recommended for this species.
Sharsmith's harebell <i>Campanula sharsmithiae</i>	List 1B	Occurs in chaparral, usually on serpentine barrens. 480-855 meters. Blooms April-June.	No Potential. The Study Area lacks suitable serpentinite barrens.	No further actions are recommended for this species.
Tiburon paintbrush <i>Castilleja affinis</i> <i>ssp. neglecta</i>	List 1B, FE, ST	Occurs in valley and foothill grassland on serpentinite soils. 60-400 meters. Blooms April-June.	No Potential. The Study Area lacks suitable serpentinite soils.	No further actions are recommended for this species.
pink creamsacs <i>Castilleja rubicundula</i> <i>ssp. rubicundula</i>	List 1B	Occurs within openings in chaparral, cismontane woodland, meadows and seeps and in valley and foothill grassland on serpentinite soils. 20-900 meters. Blooms April-June.	No Potential. The Study Area lacks suitable serpentinite soils.	No further actions are recommended for this species.
coyote ceanothus <i>Ceanothus ferrisiae</i>	List 1B, FE	Occurs in chaparral, coastal scrub and valley and foothill grassland on serpentinite soils. 120-460 meters. Blooms January-May.	No Potential. The Study Area lacks suitable serpentinite soils. This species is known from fewer than five occurrences in the Mt. Hamilton Range.	No further actions are recommended for this species.
Congdon's tarplant <i>Centromadia parryi</i> <i>ssp. congdonii</i>	List 1B	Occurs on valley and foothill grassland on alkaline soils. 1-230 meters. Blooms May-October, occasionally to November.	No Potential. The Study Area lacks suitable alkaline soils.	No further actions are recommended for this species.
Ben Lomond spineflower <i>Chorizanthe pungens</i> <i>var. hartwegiana</i>	List 1B, FE	Occurs in lower montane coniferous forest, on maritime ponderosa pine sandhills. 90-610 meters. Blooms April-July.	No Potential. The Study Area lacks suitable coniferous forest or pine sandhill habitat.	No further actions are recommended for this species.

SPECIES	STATUS *	HABITAT	POTENTIAL FOR OCCURRENCE	RECOMMENDATIONS
robust spineflower <i>Chorizanthe robusta</i> var. <i>robusta</i>	List 1B, FE	Occurs maritime chaparral, openings in cismontane woodland, coastal dunes, and sandy or gravelly coastal scrub. 3-300 meters. Blooms April-September.	No Potential. Although woodland habitat is present in the Study Area, only records of this species on east side of Santa Cruz Mountains are from 1880's.	No further actions are recommended for this species.
Mt. Hamilton fountain thistle <i>Cirsium fontinale</i> var. <i>campylon</i>	List 1B	Occurs in chaparral, cismontane woodland and valley and foothill grassland in serpentinite seeps. 100-890 meters. Blooms April-October, occasionally beginning in February.	No Potential. The Study Area lacks suitable serpentinite seep habitat.	No further actions are recommended for this species.
Crystal Springs fountain thistle <i>Cirsium fontinale</i> var. <i>fontinale</i>	List 1B, FE, SE	Occurs in chaparral openings, cismontane woodland, and valley and foothill grassland in serpentinite seeps. 46-175 meters. Blooms May-October.	No Potential. The Study Area lacks suitable serpentinite seep habitat.	No further actions are recommended for this species.
lost thistle <i>Cirsium praeteriens</i>	List 1A	Habitat unknown. Possibly an introduction from the Old World. Known from only two collections from Palo Alto, the most recent in 1901. 0-100 meters. Blooms June-July.	Moderate. Suitable habitat for this species may be present in the Study Area.	This species was not observed during rare plant surveys. No further actions are recommended for this species.
San Francisco collinsia <i>Collinsia multicolor</i>	List 1B	Occurs in closed-cone coniferous forest and coastal scrub, sometimes on serpentinite soils. 30-250 meters. Blooms March-May.	Moderate. Although scrub habitat on non-serpentinite soils is present in the Study Area, the scrub is outside of the coastal fog incursion.	This species was not observed during rare plant surveys. No further actions are recommended for this species.
Point Reyes bird's beak <i>Cordylanthus maritimus</i> ssp. <i>palustris</i>	List 1B	Occurs in coastal salt marsh. 0-10 meters. Blooms June-October.	No Potential. The Study Area lacks suitable salt marsh habitat.	No further actions are recommended for this species.

SPECIES	STATUS *	HABITAT	POTENTIAL FOR OCCURRENCE	RECOMMENDATIONS
Mt. Hamilton coreopsis <i>Coreopsis hamiltonii</i>	List 1B	Occurs in cismontane woodland on rocky soils. 550-1300 meters. Blooms March-May.	Unlikely. Although, suitable woodland habitat on rocky soils is present in the Study Area, populations are known only from the Hamilton range.	No further actions are recommended for this species.
Hospital Canyon larkspur <i>Delphinium californicum ssp. interius</i>	List 1B	Occurs in openings in chaparral, and mesic sites in cismontane woodland. 230-1095 meters. Blooms April-June.	Unlikely. Although suitable chaparral and woodland habitat is present in the Study Area, populations are known only from the eastern Coast Ranges.	No further actions are recommended for this species.
Norris' beard moss <i>Didymodon norrisii</i>	List 2	Occurs in cismontane woodland and lower montane coniferous forest on rocky, intermittently mesic sites. 600-1973 meters.	Unlikely. Although suitable woodland and forest habitat is present in the Study Area, the site is out of the elevation range of this species.	No further actions are recommended for this species.
western leatherwood <i>Dirca occidentalis</i>	List 1B	Occurs in broadleaved upland forest, closed-cone coniferous forest, chaparral, cismontane woodland, North Coast coniferous forest, riparian forest, and riparian woodland, usually on brushy slopes and mesic sites. 50-395 meters. Blooms January-March.	High. This shrub species is identifiable outside of its blooming period, and is known from sites bordering the Study Area.	This species was not observed during rare plant surveys. No further actions are recommended for this species.
Santa Clara Valley dudleya <i>Dudleya setchellii</i>	List 1B, FE	Occurs in cismontane woodland and valley and foothill grassland on rocky, serpentinite outcrops. 60-455 meters. Blooms April-October.	No Potential. The Study Area lacks serpentinite outcrops.	No further actions are recommended for this species.
Brandegee's eriastrum <i>Eriastrum brandegeeeae</i>	List 1B	Occurs in chaparral and cismontane woodland on volcanic, sandy soils. 305-1030 meters. Blooms April-August.	No Potential. The Study Area lacks suitable chaparral and woodland habitat on volcanic or sandy soils.	No further actions are recommended for this species.

SPECIES	STATUS *	HABITAT	POTENTIAL FOR OCCURRENCE	RECOMMENDATIONS
Tracy's eriastrum <i>Eriastrum tracyi</i>	List 1B, SR	Occurs in chaparral and cismontane woodland. 315-975 meters. Blooms June-July.	Unlikely. Although suitable chaparral and woodland habitat is present in the Study Area, populations are known from the eastern Coast Ranges.	No further actions are recommended for this species.
Ben Lomond buckwheat <i>Eriogonum nudum</i> var. <i>decurrens</i>	List 1B	Occurs in chaparral, cismontane woodland, and lower montane coniferous forest; usually found on maritime Ponderosa Pine sandhills. 50-800 meters. Blooms June-October.	No Potential. The Study Area lacks suitable chaparral, woodland, and forest habitats on maritime Ponderosa Pine sandhills.	No further actions are recommended for this species.
San Mateo woolly sunflower <i>Eriophyllum</i> <i>latilobum</i>	List 1B, FE, SE	Occurs in cismontane woodland, often on serpentine in roadcuts. 45-150 meters. Blooms May-June.	No Potential. The Study Area lacks suitable woodland habitat with serpentine outcrops.	No further actions are recommended for this species.
Hoover's button-celery <i>Eryngium</i> <i>aristulatum</i> var. <i>hooveri</i>	List 1B	Occur in alkaline depressions, vernal pools, roadside ditches and other wet places near the coast. 5-45 meters. Blooms in July.	No Potential. The Study Area lacks suitable alkaline depressions and vernal pool habitat.	No further actions are recommended for this species.
Santa Cruz wallflower <i>Erysimum</i> <i>teretifolium</i>	List 1B	Occurs in chaparral and lower montane coniferous forest on inland marine sands. 120-610 meters. Blooms March-July.	No Potential. The Study Area lacks lower montane coniferous forest and inland marine sand habitat.	No further actions are recommended for this species.
talus fritillary <i>Fritillaria falcata</i>	List 1B	Occurs in chaparral, cismontane woodland and lower montane coniferous forest on serpentinite talus fields. 300-1525 meters. Blooms March-May.	No Potential. The Study Area lacks suitable chaparral and woodland on serpentinite talus fields.	No further actions are recommended for this species.

SPECIES	STATUS *	HABITAT	POTENTIAL FOR OCCURRENCE	RECOMMENDATIONS
fragrant fritillary <i>Fritillaria liliacea</i>	List 1B	Occurs in cismontane woodland, coastal prairie, coastal scrub, valley and foothill grassland, usually associated with serpentine. 3-410 meters. Blooms February-April.	No Potential. The Study Area lacks suitable woodland, prairie, scrub, or grassland habitats on serpentine soils.	No further actions are recommended for this species.
short-leaved evax <i>Hespervax sparsiflora</i> var. <i>brevifolia</i>	List 2	Occurs in coastal bluff scrub and coastal dunes. 0-215 meters. Blooms March-June.	No Potential. The Study Area lacks suitable coastal bluff scrub and dune habitat.	No further actions are recommended for this species.
Marin western flax <i>Hesperolinon congestum</i>	List 1B, FT, ST	Occurs in valley and foothill grasslands and chaparral, on serpentine soils. 30-365 meters. Blooms April-July.	No Potential. The Study Area lacks suitable serpentine soils.	No further actions are recommended for this species.
Loma Prieta hoita <i>Hoita strobilina</i>	List 1B	Occurs in chaparral, cismontane woodland, riparian woodland, usually on serpentine soils and mesic sites. 30-860 meters. Blooms May-July.	No Potential. The Study Area lacks suitable chaparral and woodland habitat on serpentine soils.	No further actions are recommended for this species.
Contra Costa goldfields <i>Lasthenia conjugens</i>	List 1B, FE	Occurs in cismontane woodland, playas, valley and foothill grassland, and alkaline vernal pools. 0-470 meters. Blooms March-June.	No Potential. The Study Area lacks suitable wetland habitat.	No further actions are recommended for this species.
legenere <i>Legenere limosa</i>	List 1B	Vernal pools. 1-880 meters. Blooms April-June.	No Potential. The Study Area lacks suitable vernal pool habitat.	No further actions are recommended for this species.
woolly-headed lessingia <i>Lessingia hololeuca</i>	List 3	Occurs in broadleaved upland forest, coastal scrub, lower montane coniferous forest and valley and foothill grassland. Usually associated with clay and serpentine soils. 15-305 meters. Blooms June-October.	No potential. The Study Area lacks suitable clay and serpentine soils.	This species was not observed during rare plant surveys.

SPECIES	STATUS *	HABITAT	POTENTIAL FOR OCCURRENCE	RECOMMENDATIONS
smooth lessingia <i>Lessingia micradenia</i> var. <i>glabrata</i>	List 1B	Occurs in chaparral, cismontane woodland, usually on serpentine soils near roadsides. 120-420 meters. Blooms July-November.	No Potential. The Study Area lacks suitable serpentine soils.	No further actions are recommended for this species.
Mt. Hamilton lomatium <i>Lomatium observatorium</i>	List 1B	Occurs in cismontane woodland. 1219-1330 meters. Blooms March-May.	No Potential. Although suitable woodland habitat is present in the Study Area, the site is out of the elevation range of this species which is known from the eastern Coast Ranges.	No further actions are recommended for this species.
arcuate bushmallow <i>Malacothamnus arcuatus</i>	List 1B	Occurs in chaparral, cismontane woodland, usually in gravelly alluvium. 15-355 meters. Blooms April-September.	No Potential. The Study Area lacks suitable chaparral and woodland habitats on gravelly alluvium.	No further actions are recommended for this species.
Davidson's bushmallow <i>Malacothamnus davidsonii</i>	List 1B	Occurs in chaparral, cismontane woodland, coastal scrub and riparian woodland, usually in sandy washes. 185-855 meters. Blooms June-January.	No Potential. The Study Area lacks suitable chaparral, woodland, and scrub habitat in sandy washes.	No further actions are recommended for this species.
Hall's bushmallow <i>Malacothamnus hallii</i>	List 1B	Occurs in chaparral, coastal scrub, some populations on serpentine. 10-760 meters. Blooms May-September.	Moderate. Suitable chaparral habitat on non-serpentine soils is present in the Study Area. Populations known from sites neighboring the Study Area.	This species was not observed during rare plant surveys. No further actions are recommended for this species.
Oregon meconella <i>Meconella oregana</i>	List 1B	Occurs in coastal prairie and coastal scrub. 250-620 meters. Blooms March-April.	No Potential. The Study Area lacks suitable coastal scrub and prairie habitat.	No further actions are recommended for this species.
Mt. Diablo cottonweed <i>Micropus amphibolus</i>	List 3	Occurs in broadleaved upland forest, chaparral, cismontane woodland, valley and foothill grassland in rocky soils. 45-825 meters. Blooms March-May.	Moderate. Suitable habitat with rocky bare ground is present in the Study Area.	This species was not observed during rare plant surveys. No further actions are recommended for this species.

SPECIES	STATUS *	HABITAT	POTENTIAL FOR OCCURRENCE	RECOMMENDATIONS
San Antonio Hills monardella <i>Monardella antonina</i> ssp. <i>antonina</i>	List 3	Occurs in chaparral and cismontane woodland. 500-1000 meters. Blooms June-August.	Unlikely. Although suitable chaparral and woodland habitat is present in the Study Area, the site is out of the elevation range of the species.	No further actions are recommended for this species.
robust monardella <i>Monardella villosa</i> ssp. <i>globosa</i>	List 1B	Occurs in openings in chaparral, broadleafed upland forest, cismontane woodland, and valley and foothill grassland. 30-915 meters. Blooms June-July.	High. Suitable chaparral, forest, and woodland habitat is present in the Study Area and populations are known from a contiguous ridgeline within 2 miles.	This species was not observed during rare plant surveys. No further actions are recommended for this species.
prostrate navarretia <i>Navarretia prostrata</i>	List 1B	Occurs in coastal scrub, meadows and seeps, valley and foothill grassland, and alkaline vernal pools. 15-700 meters. Blooms April-July.	No Potential. The Study Area lacks suitable seep and vernal pool habitats.	No further actions are recommended for this species.
Kellman's bristle moss <i>Orthotrichum kellmanii</i>	List 1B	Occurs in chaparral and cismontane woodland. Restricted to sandstone outcrops. 343-685 meters. Blooms January-February.	No Potential. The Study Area lacks suitable sandstone outcrops.	No further actions are recommended for this species.
Dudley's lousewort <i>Pedicularis dudleyi</i>	List 1B, SR	Occurs in chaparral, lower montane coniferous forest, North Coast coniferous forest. 60-900 meters. Blooms April-June.	Moderate. Suitable chaparral and forest habitat is present in the Study Area.	This species was not observed during rare plant surveys. No further actions are recommended for this species.
Santa Cruz mountains beardtongue <i>Penstemon rattanii</i> var. <i>kleei</i>	List 1B	Occurs in chaparral, lower montane coniferous forest and North Coast coniferous forest, usually on sandy shale slopes and sometimes in the transition zone between forest and chaparral. 400-1100 meters. Blooms May-June.	Moderate. Suitable chaparral and forest habitat is present in the Study Area.	This species was not observed during rare plant surveys. No further actions are recommended for this species.

SPECIES	STATUS *	HABITAT	POTENTIAL FOR OCCURRENCE	RECOMMENDATIONS
white-rayed pentacheata <i>Pentachaeta bellidiflora</i>	List 1B, FE, SE	Occurs in valley and foothill grassland, often associated with serpentine soils. 35-620 meters. Blooms March-May.	No Potential. The Study Area lacks suitable grassland habitat on serpentine soils.	No further actions are recommended for this species.
San Benito pentachaeta <i>Pentachaeta exilis</i> <i>ssp. aeolica</i>	List 1B	Occurs in cismontane woodland and valley and foothill grassland. 640-855 meters. Blooms March-May.	Unlikely. Although suitable woodland and grassland habitat is present in the Study Area, the site is out of the range of the known elevation for this species.	No further actions are recommended for this species.
Mt. Diablo phacelia <i>Phacelia phacelioides</i>	List 1B	Occurs in chaparral and cismontane woodland in rocky soils. 500-1370 meters. Blooms April-May.	Unlikely. Although suitable chaparral and woodland habitat is present in the Study Area, the site is out of the known elevation range for this species.	No further actions are recommended for this species.
white-flowered rein orchid <i>Piperia candida</i>	List 1B	Occurs in broadleaved upland forest, lower montane coniferous forest and North Coast coniferous forest, occasionally on serpentinite soils. 30-1310 meters. Blooms May-September.	Moderate. Suitable forest habitat on non-serpentine soils is present in the Study Area.	This species was not observed during rare plant surveys. No further actions are recommended for this species.
hairless popcorn-flower <i>Plagiobothrys glaber</i>	List 1A	Occurs in alkaline meadows and seeps, coastal salt marshes and swamps. 15-180 meters. Blooms March-May.	No Potential. The Study Area lacks suitable alkaline meadows and seeps and suitable coastal salt marshes and swamps.	No further actions are recommended for this species.
hooked popcorn-flower <i>Plagiobothrys uncinatus</i>	List 1B	Occurs in chaparral (sometimes on sandy soils), cismontane woodland and valley and foothill grassland. 300-760 meters. Blooms April-May.	Moderate. Suitable chaparral, woodland, and grassland habitat is present in the Study Area.	This species was not observed during rare plant surveys. No further actions are recommended for this species.
slender-leaved pondweed <i>Potamogeton filiformis</i>	List 2	Occurs in assorted shallow freshwater marshes and swamps. 300-2150 meters. Blooms May-July.	No Potential. The Study Area lacks suitable freshwater marsh and swamp habitat.	No further actions are recommended for this species.

SPECIES	STATUS *	HABITAT	POTENTIAL FOR OCCURRENCE	RECOMMENDATIONS
rock sanicle <i>Sanicula saxatilis</i>	List 1B, SR	Occurs in broadleaved upland forest, chaparral and valley and foothill grassland, on rocky soils and outcrops. 620-1175 meters. Blooms April-May.	Unlikely. Although suitable forest, chaparral, and grassland habitat is present in the Study Area, the site is out of the known elevation range of this species.	No further actions are recommended for this species.
chaparral ragwort <i>Senecio aphanactis</i>	List 2	Occurs in chaparral, cismontane woodland, and coastal scrub, often alkaline soils. 15-800 meters. Blooms January-April.	No Potential. The Study Area lacks suitable alkaline soils.	No further actions are recommended for this species.
San Francisco campion <i>Silene verecunda</i> ssp. <i>verecunda</i>	List 1B	Occurs in coastal bluff scrub, chaparral, coastal prairie, coastal scrub and valley and foothill grassland, often on mudstone or shale. 30-645 meters. Blooms March-June.	Unlikely. Although suitable chaparral and grassland habitat is present in the Study Area, this species is known primarily from sites with coastal fog incursion.	No further actions are recommended for this species.
Santa Cruz microseris <i>Stebbinoseris decipiens</i>	List 1B	Occurs in openings in broadleaved upland forest, closed-cone coniferous forest, chaparral, coastal prairie, coastal scrub and valley and foothill grassland. Sometimes on serpentine soils. 10-500 meters. Blooms April-May.	Moderate. Suitable forest, chaparral, and grassland habitat on non-serpentinite is present in the Study Area.	This species was not observed during rare plant surveys. No further actions are recommended for this species.
Metcalf Canyon jewel-flower <i>Streptanthus albidus</i> ssp. <i>albidus</i>	List 1B, FE	Occurs in relatively open areas in dry grassy meadows on serpentine soils and serpentine balds. 45-800 meters. Blooms April-July.	No Potential. The Study Area lacks suitable serpentinite soils and serpentinite bald habitat.	No further actions are recommended for this species.
most beautiful jewel-flower <i>Streptanthus albidus</i> ssp. <i>peramoenus</i>	List 1B	Occurs in chaparral, cismontane woodland and valley and foothill grassland, often on serpentine soils. 110-1000 meters. Blooms April-June.	No Potential. The Study Area lacks suitable serpentine soils.	No further actions are recommended for this species.

SPECIES	STATUS *	HABITAT	POTENTIAL FOR OCCURRENCE	RECOMMENDATIONS
Mt. Hamilton jewel-flower <i>Streptanthus callistus</i>	List 1B	Occurs in chaparral and cismontane woodland. 600-790 meters. Blooms April-May.	Unlikely. Although suitable chaparral and woodland habitat is present in the Study Area, the site is out of the known elevation range of this species. Additionally, this species is known from approximately five occurrences in the Mt. Hamilton Range.	No further actions are recommended for this species.
California seablite <i>Sueda californica</i>	List 1B, FE	Occurs in coastal salt marshes and swamps. 0-15 meters. Blooms July-October.	No Potential. The Study Area lacks suitable coastal salt marshes and swamps.	No further actions are recommended for this species.
two-fork clover <i>Trifolium amoenum</i>	List 1B, FE	Occurs in coastal bluff scrub and valley and foothill grassland, occasionally on serpentinite soils. 5-415 meters. Blooms April-June.	Unlikely. Although suitable grassland habitat on non-serpentinite soils is present in the Study Area. The known occurrence in the Vicinity of the Study Area date from 1903.	No further actions are recommended for this species.
saline clover <i>Trifolium depauperatum</i> var. <i>hydrophilum</i>	List 1B	Typically found in valley and foothill grassland or vernal pools in mesic, alkaline soils. Occasionally in marshes and swamps. 0-300m. Blooms April-June.	No Potential. The Study Area lacks suitable vernal pool or grassland habitats on alkaline soils.	No further actions are recommended for this species.
caper-fruited tropidocarpum <i>Tropidocarpum capparideum</i>	List 1B	Occurs in valley and foothill grassland on alkaline clay soils. 0-455 meters. Blooms March-April.	No Potential. The Study Area lacks suitable grassland habitat on alkline clay soils. The known occurrences in the vicinity of the Study Area date from 1902 and 1907, and may have been incorrectly identified.	No further actions are recommended for this species.
Methuselah's beard lichen <i>Usnea longissima</i>	none	Occurs in North Coast coniferous forest, closed-cone coniferous forest and cismontane woodland. Found near open water, either the margins of rivers and streams or of lakes or standing water in swamps.	Moderate. Suitable woodland habitat is present in the Study Area.	This species was not observed during rare plant surveys. No further actions are recommended for this species.

SPECIES	STATUS	HABITAT	POTENTIAL FOR OCCURRENCE	RECOMMENDATIONS
* Key to status codes:				
FE	Federal Endangered			
FT	Federal Threatened			
FC	Federal Candidate			
FD	Federal De-listed			
FPD	Federal Proposed for De-listing			
NMFS	Species under the Jurisdiction of the National Marine Fisheries Service			
BCC	USFWS Birds of Conservation Concern			
RP	Sensitive species included in a USFWS Recovery Plan or Draft Recovery Plan			
SE	State Endangered			
ST	State Threatened			
SR	State Rare			
CSC	CDFG Species of Special Concern			
Draft CSC	4 April 2000 Draft CDFG Species of Special Concern			
CFP	CDFG Fully Protected Animal			
SSI	CDFG Special Status Invertebrates			
SLC	Species of Local Concern - Included for coverage under a Habitat Conservation Plan (HCP)			
WBWG	Western Bat Working Group High Priority species			
List 1A	CNPS List 1A: Plants presumed extinct in California			
List 1B	CNPS List 1B: Plants rare, threatened or endangered in California and elsewhere			
List 2	CNPS List 2: Plants rare, threatened, or endangered in California, but more common elsewhere			
List 3	CNPS List 3: Plants about which CNPS needs more information (a review list)			

APPENDIX B
SPECIES OBSERVED IN THE RPA AREA

Appendix B. Species Observed Within and Surrounding Study Area, 2008 - 2009.

Scientific name	Common name
MAMMALS	
<i>Neotoma fuscipes annectens</i>	San Francisco Dusky-footed Woodrat
<i>Peromyscus californicus</i>	California Deer Mouse
<i>Sylvilagus bachmani</i>	Brush Rabbit
<i>Sciurus griseus</i>	Western Gray Squirrel
<i>Spermophilus beecheyi</i>	California Ground Squirrel
<i>Canis latrans</i>	Coyote
<i>Procyon lotor</i>	Raccoon
<i>Odocoileus hemionus</i>	Mule Deer
BIRDS	
<i>Cathartes aura</i>	Turkey Vulture
<i>Elanus leucurus</i>	White-tailed Kite
<i>Falco sparverius</i>	American Kestrel
<i>Buteo jamaicensis</i>	Red-tailed Hawk
<i>Callipepla californica</i>	California Quail
<i>Zenaida macroura</i>	Mourning Dove
<i>Columba livia</i>	Rock Pigeon
<i>Columba fasciata</i>	Band-tailed Pigeon
<i>Calypte anna</i>	Anna's Hummingbird
<i>Picoides villosus</i>	Hairy Woodpecker
<i>Picoides nuttallii</i>	Nuttall's Woodpecker
<i>Colaptes auratus</i>	Northern Flicker
<i>Sayornis nigricans</i>	Black Phoebe
<i>Vireo huttoni</i>	Hutton's Vireo
<i>Cyanocitta stelleri</i>	Steller's Jay
<i>Aphelocoma californica</i>	Western Scrub Jay
<i>Corvus Corax</i>	Common Raven
<i>Corvus brachyrhychos</i>	American Crow
<i>Baeolophus inornatus</i>	Oak Titmouse
<i>Poecile rufescens</i>	Chestnut-backed Chickadee
<i>Psaltriparus minimus</i>	Bushtit
<i>Certhia americana</i>	Brown Creeper
<i>Thryomanes bewickii</i>	Bewick's Wren
<i>Chamaea fasciata</i>	Wrentit
<i>Regulus calendula</i>	Ruby-crowned Kinglet
<i>Catharus guttatus</i>	Hermit Thrush
<i>Toxostoma redivivum</i>	California Thrasher
<i>Pipilo maculatus</i>	Spotted Towhee
<i>Pipilo crissalis</i>	California Towhee
<i>Zonotricha atricapilla</i>	Golden-crowned Sparrow
<i>Zonotricha leucophrys</i>	White-crowned Sparrow
<i>Passerella iliaca</i>	Fox Sparrow
<i>Melospiza melodia</i>	Song Sparrow
<i>Junco hyemalis</i>	Dark-eyed Junco
<i>Sturnella neglecta</i>	Western Meadowlark
<i>Agelaius phoeniceus</i>	Red-winged Blackbird
<i>Carduelis psaltria</i>	Lesser Goldfinch
AMPHIBIANS	
<i>Batrachoseps attenuatus</i>	California Slender Salamander

Scientific name		Common name
<i>Hyla regilla</i>		Pacific Tree Frog
REPTILES		
<i>Thamnophis elegans</i>		Western Terrestrial Garter Snake
<i>Diadophis punctatus</i>		Ringneck Snake
<i>Crotalus viridis</i>		Western Rattlesnake
PLANTS		
Family	Scientific name	Common name
Amaranthaceae	<i>Amaranthus albus</i>	pigweed amaranth
Anacardiaceae	<i>Toxicodendron diversilobum</i>	poison oak
Anacardiaceae	<i>Rhus trilobata</i>	skunk brush
Anacardiaceae	<i>Schinus molle</i>	Peruvian pepper tree
Apiaceae	<i>Torilis arvensis</i>	hedge parsley
Apiaceae	<i>Anthriscus caucalis</i>	bur chervil
Apiaceae	<i>Foeniculum vulgare</i>	sweet fennel
Apiaceae	<i>Osmorhiza chilensis</i>	sweet cicely
Apiaceae	<i>Sanicula crassicaulis</i>	Pacific sanicle
Apiaceae	<i>Scandix pecten-veneris</i>	Venus' needle
Apocynaceae	<i>Nerium oleander (Horticultural)</i>	oleander
Apocynaceae	<i>Vinca major</i>	periwinkle
Araliaceae	<i>Hedera helix</i>	English ivy
Asteraceae	<i>Xanthium strumarium</i>	cocklebur
Asteraceae	<i>Achillea millefolium</i>	common yarrow
Asteraceae	<i>Achyrrachaena mollis</i>	blow wifes
Asteraceae	<i>Adenocaulon bicolor</i>	trailfinder
Asteraceae	<i>Anaphalis margaritacea</i>	pearly everlasting
Asteraceae	<i>Artemisia californica</i>	California sagebrush
Asteraceae	<i>Artemisia douglasiana</i>	California mugwort
Asteraceae	<i>Artemisia dracunculus</i>	tarragon
Asteraceae	<i>Aster radulensis</i>	rough-leaved aster
Asteraceae	<i>Baccharis pilularis</i>	coyote brush
Asteraceae	<i>Carduus pycnocephalus</i>	Italian thistle
Asteraceae	<i>Centaurea calcitrapa</i>	purple star thistle
Asteraceae	<i>Centaurea melitensis</i>	toocalote
Asteraceae	<i>Centaurea solstitialis</i>	yellow star thistle
Asteraceae	<i>Cichorium intybus</i>	chickory
Asteraceae	<i>Cirsium arvense</i>	canada thistle
Asteraceae	<i>Cirsium occidentale</i>	cobweb thistle
Asteraceae	<i>Cirsium vulgare</i>	bull thistle
Asteraceae	<i>Conyza canadensis</i>	horseweed
Asteraceae	<i>Dittrichia graveolens</i>	stinkwort
Asteraceae	<i>Eriophyllum confertiflorum</i>	golden yarrow
Asteraceae	<i>Eriophyllum lanatum</i>	woolly sunflower
Asteraceae	<i>Filago gallica</i>	Filago
Asteraceae	<i>Gnaphalium californicum</i>	California cudweed
Asteraceae	<i>Gnaphalium canescens ssp beneolens</i>	cudweed
Asteraceae	<i>Gnaphalium luteo-album</i>	everlasting cudweed
Asteraceae	<i>Grindelia camporum</i>	Great Valley gumweed
Asteraceae	<i>Heterotheca grandiflora</i>	telegraphweed
Asteraceae	<i>Hieracium albiflorum</i>	white hawkweed
Asteraceae	<i>Hypochaeris glabra</i>	smooth catsear
Asteraceae	<i>Hypochaeris radicata</i>	rough catsear
Asteraceae	<i>Lactuca serriola</i>	prickly wild lettuce

Family	Scientific name	Common name
Asteraceae	<i>Lactuca virosa</i>	bitter lettuce
Asteraceae	<i>Lagophylla ramosissima</i> ssp. <i>ramosissima</i>	common hareleaf
Asteraceae	<i>Madia elegans</i>	common madia
Asteraceae	<i>Madia exigua</i>	meager tarweed
Asteraceae	<i>Madia sativa</i>	coast tarweed
Asteraceae	<i>Picris echioides</i>	bristly ox-tongue
Asteraceae	<i>Senecio vulgare</i>	common groundsel
Asteraceae	<i>Silybum marianum</i>	milk thistle
Asteraceae	<i>Sonchus asper</i>	prickly sow thistle
Asteraceae	<i>Sonchus oleraceus</i>	common sow thistle
Asteraceae	<i>Stylocline gnaphaloides</i>	everlasting nest straw
Asteraceae	<i>Uropappus lindleyi</i>	silver puffs
Asteraceae	<i>Wyethia glabra</i>	smooth mule ears
Asteraceae	<i>Wyethia helenioides</i>	whitehead mule ears
Berberidaceae	<i>Berberis pinnata</i> ssp. <i>pinnata</i>	California barberry
Betulaceae	<i>Alnus rhombifolia</i>	white alder
Blechnaceae	<i>Woodwardia fimbriata</i>	giant chain fern
Boraginaceae	<i>Amsinckia tessellata</i>	fiddle neck
Boraginaceae	<i>Amsinckia menziesii</i>	fiddle neck
Boraginaceae	<i>Plagiobothrys nothofulvus</i>	rusty popcornflower
Boraginaceae	<i>Cryptantha clevelandii</i>	common cryptantha
Boraginaceae	<i>Cynoglossum grande</i>	hound's tongue
Boraginaceae	<i>Heliotropium curassavicum</i>	heliotrope
Brachytheciaceae	<i>Homalothecium pinnatifidum</i>	pinnatifid homalothecium moss
Brassicaceae	<i>Lepidium latipes</i>	dwarf pepperweed
Brassicaceae	<i>Brassica nigra</i>	black mustard
Brassicaceae	<i>Brassica rapa</i>	wild mustard
Brassicaceae	<i>Capsella bursa-pastoris</i>	shepherd's purse
Brassicaceae	<i>Cardamine oligosperma</i>	bitter cress
Brassicaceae	<i>Streptanthus glandulosus</i> ssp. <i>glandulosus</i>	bristly jewelflower
Brassicaceae	<i>Nasturtium officinale</i>	water cress
Brassicaceae	<i>Raphanus sativus</i>	wild radish
Brassicaceae	<i>Rapistrum rugosum</i>	wild turnip*
Brassicaceae	<i>Sinapis arvensis</i>	charlock mustard
Bryaceae	<i>Bryum</i> sp.	bryum moss
Caprifoliaceae	<i>Lonicera hispidula</i> var. <i>vacillans</i>	California honeysuckle
Caprifoliaceae	<i>Lonicera interrupta</i>	chaparral honeysuckle
Caprifoliaceae	<i>Sambucus mexicana</i>	blue elderberry
Caprifoliaceae	<i>Symphoricarpos albus</i>	snowberry
Caprifoliaceae	<i>Symphoricarpos mollis</i>	creeping snowberry
Caryophyllaceae	<i>Stellaria media</i>	common chickweed
Caryophyllaceae	<i>Cerastium arvense</i>	field chickweed
Caryophyllaceae	<i>Cerastium glomeratum</i>	sticky chickweed
Chenopodiaceae	<i>Atriplex lentiformis</i> ssp. <i>lentiformis</i>	big saltbush
Chenopodiaceae	<i>Salsola soda</i>	alkali russian thistle
Convolvulaceae	<i>Calystegia</i> sp.	morning glory
Convolvulaceae	<i>Convolvulus arvensis</i>	field bindweed
Corylaceae	<i>Corylus cornuta</i> var. <i>californica</i>	California hazel
Cucurbitaceae	<i>Marah fabaceus</i>	california manroot
Cupressaceae	<i>Cupressus sempervirens</i> (Horticultural)	Italian cypress
Cupressaceae	<i>Calocedrus decurrens</i>	incense cedar
Cyperaceae	<i>Schoenoplectus acutus</i>	common three square

Family	Scientific name	Common name
Cyperaceae	<i>Cyperus eragrostis</i>	tall flat-sedge
Cyperaceae	<i>Eleocharis macrostachya</i>	common spikerush
Cyperaceae	<i>Schoenoplectus americanus</i>	chairmaker's bulrush
Dennstaedtiaceae	<i>Pteridium aquilinum</i>	bracken fern
Dryopteridaceae	<i>Athyrium filix-femina</i> var. <i>cyclosorum</i>	lady fern
Dryopteridaceae	<i>Dryopteris arguta</i>	coast wood fern
Equisetaceae	<i>Equisetum arvense</i>	common horsetail
Equisetaceae	<i>Equisetum telmateia</i> ssp. <i>braunii</i>	giant horsetail
Ericaceae	<i>Arctostaphylos viscida</i>	white-leaf manzanita
Ericaceae	<i>Arbutus menziesii</i>	Pacific madrone
Ericaceae	<i>Arctostaphylos glandulosa</i>	Eastwood manzanita
Ericaceae	<i>Arctostaphylos glauca</i>	big berry manzanita
Ericaceae	<i>Arctostaphylos tomentosa</i> ssp. <i>crustacea</i>	brittleleaf manzanita
Euphorbiaceae	<i>Eremocarpus setigerus</i>	turkey mullein
Fabaceae	<i>Cytisus scoparius</i>	Scotch broom
Fabaceae	<i>Lathyrus tingitanus</i>	Tangier pea
Fabaceae	<i>Lathyrus vestitus</i> var. <i>vestitus</i>	wild pea
Fabaceae	<i>Lotus corniculatus</i>	birdfoot deervetch
Fabaceae	<i>Lotus humistratus</i>	short podded trefoil
Fabaceae	<i>Lotus purshianus</i> var. <i>purshianus</i>	Spanish clover
Fabaceae	<i>Lotus scoparius</i>	deerweed
Fabaceae	<i>Lotus wrangelianus</i>	Chilean trefoil
Fabaceae	<i>Lupinus bicolor</i>	miniature lupine
Fabaceae	<i>Lupinus microcarpus</i> var. <i>densiflorus</i>	chick lupine
Fabaceae	<i>Lupinus nanus</i>	sky lupine
Fabaceae	<i>Lupinus succulentus</i>	succulent lupine
Fabaceae	<i>Medicago polymorpha</i>	bur clover
Fabaceae	<i>Medicago sativa</i>	alfalfa
Fabaceae	<i>Mellilotus indicus</i>	annual sweetclover
Fabaceae	<i>Pickeringia montana</i>	Chaparral pea
Fabaceae	<i>Rupertia physodes</i>	California tea
Fabaceae	<i>Trifolium dubium</i>	shamrock
Fabaceae	<i>Trifolium hirtum</i>	rose clover
Fabaceae	<i>Trifolium incarnatum</i>	crimson clover
Fabaceae	<i>Trifolium subterraneum</i>	subterranean clover
Fabaceae	<i>Trifolium wildenovii</i>	tomcat clover
Fabaceae	<i>Vicia cracca</i>	bird vetch
Fabaceae	<i>Vicia villosa</i>	hairy vetch
Fabaceae	<i>Vicia sativa</i> ssp. <i>sativa</i>	common vetch
Fagaceae	<i>Lithocarpus densiflorus</i>	tanoak
Fagaceae	<i>Quercus agrifolia</i>	coast live oak
Fagaceae	<i>Quercus berberidifolia</i>	scrub oak
Fagaceae	<i>Quercus chrysolepis</i>	canyon live oak
Fagaceae	<i>Quercus douglasii</i>	blue oak
Fagaceae	<i>Quercus durata</i>	leather oak
Fagaceae	<i>Quercus wislizeni</i>	interior live oak
Fissidentaceae	<i>Fissidens limbatas</i>	fissidens moss
Garryaceae	<i>Garrya elliptica</i>	coast silk tassel
Gentianaceae	<i>Centaurium muehlenbergii</i>	Muehlenberg's centaury
Geraniaceae	<i>Erodium botrys</i>	broadleaf filaree
Geraniaceae	<i>Erodium cicutarium</i>	redstem filaree
Geraniaceae	<i>Geranium dissectum</i>	cutleaf geranium

Family	Scientific name	Common name
Geraniaceae	<i>Geranium molle</i>	dovefoot geranium
Grossulariaceae	<i>Ribes californicum</i>	hillside gooseberry
Grossulariaceae	<i>Ribes malvaceum</i>	chaparral currant
Grossulariaceae	<i>Ribes sanguineum</i>	flowering red currant
Hippocastanaceae	<i>Aesculus californica</i>	California buckeye
Hydrophyllaceae	<i>Phacelia cicutaria</i>	caterpillar phacelia
Hydrophyllaceae	<i>Eriodictyon californicum</i>	yerba santa
Hydrophyllaceae	<i>Nemophila heterophylla</i>	canyon nemophila
Hydrophyllaceae	<i>Nemophila menziesii</i>	baby blue eyes
Hydrophyllaceae	<i>Nemophila parviflora</i>	smallflower nemophila
Hydrophyllaceae	<i>Phacelia campanularia</i>	desert bells
Hypericaceae	<i>Hypericum calycinum</i>	Aaron's beard
Iridaceae	<i>Iris douglasiana</i>	Douglas' iris
Iridaceae	<i>Iris fernaldii</i>	Fernald's iris
Iridaceae	<i>Sisyrinchium bellum</i>	blue-eyed grass
Juncaceae	<i>Luzula comosa</i>	woodland rush
Juncaceae	<i>Juncus effusus</i>	common rush
Juncaceae	<i>Juncus patens</i>	spreading rush
Juncaceae	<i>Juncus xiphioides</i>	irisleaf rush
Lamiaceae	<i>Stachys pycnantha</i>	short spike hedge nettle
Lamiaceae	<i>Lepechinia calycina</i>	white pitcher sage
Lamiaceae	<i>Monardella villosa ssp. villosa</i>	coyote mint
Lamiaceae	<i>Nepeta cataria</i>	catnip
Lamiaceae	<i>Pogogyne seraphylloides</i>	thyme leaf mesamint
Lamiaceae	<i>Salvia columbariae</i>	chia
Lamiaceae	<i>Salvia leucophylla</i>	purple sage
Lamiaceae	<i>Salvia mellifera</i>	black sage
Lamiaceae	<i>Satureja douglasii</i>	yerba buena
Lamiaceae	<i>Scutellaria tuberosa</i>	blue skullcap
Lamiaceae	<i>Stachys albens</i>	cobwebby hedge nettle
Lamiaceae	<i>Stachys bullata</i>	California hedgenettle
Lauraceae	<i>Umbellularia californica</i>	California bay
Liliaceae	<i>Brodiaea elegans</i>	harvest brodiaea
Liliaceae	<i>Calochortus albus</i>	white fairy lantern
Liliaceae	<i>Calochortus luteus</i>	yellow mariposa lily
Liliaceae	<i>Calochortus superbus</i>	superb mariposa lily
Liliaceae	<i>Calochortus venustus</i>	butterfly Mariposa lily
Liliaceae	<i>Chlorogalum pomeridianum</i>	soap plant
Liliaceae	<i>Dichlostemma capitatum</i>	blue dicks
Liliaceae	<i>Fritillaria affinis</i>	checker lily
Liliaceae	<i>Zigadenus venenosus var venenosus</i>	death camas
Liliaceae	<i>Triteleia laxa</i>	Ithuriel's spear
Liliaceae	<i>Zigadenus fremontii</i>	death camas
Linaceae	<i>Linum grandiflorum</i>	flowering flax
Lythraceae	<i>Lythrum hyssopifolium</i>	Hyssop's loosestrife
Malvaceae	<i>Malacothamnus fremontii</i>	fremont's bushmallow
Malvaceae	<i>Malacothamnus fasciculatus</i>	chaparral bushmallow
Malvaceae	<i>Malva parviflora</i>	cheeseweed
Mniaceae	<i>Leucolepis acanthoneuron</i>	leucolepis umbrella moss
Myricaceae	<i>Myrica californica</i>	California wax myrtle
Myrtaceae	<i>Eucalyptus globulus</i>	blue gum
Neckeraceae	<i>Neckera douglasii</i>	Douglas neckera

Family	Scientific name	Common name
Nyctaginaceae	<i>Mirabilis californica</i>	California four o'clock
Oleaceae	<i>Olea europa (horticultural)</i>	European olive
Onagraceae	<i>Epilobium canum</i>	California fuschia
Onagraceae	<i>Camissonia ovata</i>	sun cup
Onagraceae	<i>Clarkia purpurea ssp. quadrivulnera</i>	winecup clarkia
Onagraceae	<i>Clarkia unguiculata</i>	woodland clarkia
Onagraceae	<i>Epilobium brachycarpum</i>	annual fireweed
Onagraceae	<i>Epilobium ciliatum var. ciliatum</i>	fringed willowherb
Orchidaceae	<i>Corallorhiza striata</i>	striped coralroot
Orchidaceae	<i>Piperia elegans</i>	elegant rein orchid
Orobanchaceae	<i>Orobanche bulbosa</i>	chaparral broomrape
Orobanchaceae	<i>Orobanche fasciculata</i>	clustered broomrape
Papaveraceae	<i>Stylomecon heterophylla</i>	wind poppy
Papaveraceae	<i>Eschscholzia californica</i>	California poppy
Pinaceae	<i>Cedrus deodara</i>	Deodar cedar
Pinaceae	<i>Pinus contorta</i>	lodgpole pine
Plantaginaceae	<i>Plantago erecta</i>	California plantain
Plantaginaceae	<i>Plantago lanceolata</i>	English plantain
Plantaginaceae	<i>Plantago major</i>	common plantain
Poaceae	<i>Aira caryophylla</i>	silver hairgrass
Poaceae	<i>Arrhenatherum eliatum</i>	tall oatgrass
Poaceae	<i>Avena barbata</i>	slender wild oats
Poaceae	<i>Avena fatua</i>	common wild oats
Poaceae	<i>Brachypodium distachyon</i>	false brome
Poaceae	<i>Briza minor</i>	little quaking grass
Poaceae	<i>Bromus carinatus</i>	California brome
Poaceae	<i>Bromus catharticus</i>	rescue grass
Poaceae	<i>Bromus diandrus</i>	rippgut brome
Poaceae	<i>Bromus hordeaceus</i>	soft chess
Poaceae	<i>Bromus japonicus</i>	Japanese brome
Poaceae	<i>Bromus madritensis ssp. rubens</i>	foxtail brome
Poaceae	<i>Vulpia microstachys</i>	three-weeks fescue
Poaceae	<i>Bromus sterilis</i>	poverty brome
Poaceae	<i>Bromus vulgaris</i>	Columbia brome
Poaceae	<i>Cortaderia selloana</i>	pampas grass
Poaceae	<i>Cynodon dactylon</i>	bermuda grass
Poaceae	<i>Cynosurus echinatus</i>	hedgehog dogtail grass
Poaceae	<i>Dactylis glomerata</i>	orchard grass
Poaceae	<i>Elymus glaucus</i>	blue wildrye
Poaceae	<i>Elymus multisetas</i>	big squirreltail grass
Poaceae	<i>Festuca arundinacea</i>	tall fescue
Poaceae	<i>Festuca occidentalis</i>	western fescue
Poaceae	<i>Festuca rubra</i>	red fescue
Poaceae	<i>Gastridium ventricosum</i>	nit grass
Poaceae	<i>Hordeum marinum ssp. gussoneanum</i>	Mediterranean barley
Poaceae	<i>Hordeum murinum ssp. leporinum</i>	foxtail barley
Poaceae	<i>Leymus triticoides</i>	creeping wild rye
Poaceae	<i>Lolium multiflorum</i>	Italian ryegrass
Poaceae	<i>Melica californica</i>	California melic grass
Poaceae	<i>Melica imperfecta</i>	small flowered melica
Poaceae	<i>Nassella lepida</i>	small flowered needlegrass
Poaceae	<i>Nassella pulchra</i>	purple needle grass

Family	Scientific name	Common name
Poaceae	<i>Panicum capillare</i>	witchgrass
Poaceae	<i>Phalaris aquatica</i>	Harding grass
Poaceae	<i>Phalaris californica</i>	California canarygrass
Poaceae	<i>Piptatherum miliaceum</i>	smilgrass
Poaceae	<i>Poa annua</i>	annual bluegrass
Poaceae	<i>Polypogon monspeliensis</i>	rabbitsfoot grass
Poaceae	<i>Taeniantherum caput-medusae</i>	Medusa-head grass
Poaceae	<i>Vulpia myuros</i>	rattail fescue
Polemoniaceae	<i>Eriastrum abramsii</i>	Abram's woolly star
Polemoniaceae	<i>Navarretia heterodoxa</i>	Calistoga pincushion plant
Polemoniaceae	<i>Navarretia squarrosa</i>	skunkbush
Polygonaceae	<i>Rumex pulcher</i>	fiddle dock
Polygonaceae	<i>Eriogonum fasciculatum</i>	california buckwheat
Polygonaceae	<i>Eriogonum giganteum</i> var. <i>giganteum</i> (planted)	Santa Catalina Island buckwheat
Polygonaceae	<i>Eriogonum nudum</i>	naked buckwheat
Polygonaceae	<i>Polygonum arenastrum</i>	common knotweed
Polygonaceae	<i>Rumex conglomeratus</i>	clustered dock
Polygonaceae	<i>Rumex crispus</i>	curly dock
Polypodiaceae	<i>Polypodium californicum</i>	California polypody
Portulacaceae	<i>Calandrinia ciliata</i>	red maids
Portulacaceae	<i>Claytonia parviflora</i>	miner's lettuce
Portulacaceae	<i>Claytonia perfoliata</i>	miner's lettuce
Portulacaceae	<i>Claytonia siberica</i>	candyflower
Primulaceae	<i>Anagallis arvensis</i>	scarlet pimpernell
Primulaceae	<i>Trientalis latifolia</i>	star-flower
Pteridaceae	<i>Pellaea andromedifolia</i>	coffee fern
Pteridaceae	<i>Adiantum aleuticum</i>	five-finger fern
Pteridaceae	<i>Adiantum jordanii</i>	California maiden-hair fern
Pteridaceae	<i>Pentagramma triangularis</i>	gold back fern
Ranunculaceae	<i>Delphinium californicum</i> ssp. <i>californicum</i>	coast larkspur
Ranunculaceae	<i>Actaea rubra</i>	baneberry
Ranunculaceae	<i>Aquilegia formosa</i>	western columbine
Ranunculaceae	<i>Clematis lasiantha</i>	chaparral clematis
Ranunculaceae	<i>Thalictrum fendleri</i> var. <i>fendleri</i>	Fendler's meadow rue
Ranunculaceae	<i>Delphinium nudicale</i>	red larkspur
Ranunculaceae	<i>Ranunculus californicus</i>	common buttercup
Ranunculaceae	<i>Ranunculus canus</i>	Great Valley buttercup
Rhamnaceae	<i>Rhamnus tomentella</i>	hoary coffeeberry
Rhamnaceae	<i>Ceanothus cuneatus</i>	buckbrush
Rhamnaceae	<i>Ceanothus integerrimus</i>	deer brush
Rhamnaceae	<i>Ceanothus leucodermis</i>	chaparral whitethorn
Rhamnaceae	<i>Ceanothus oliganthus</i>	hairy ceanothus
Rhamnaceae	<i>Rhamnus californicus</i>	coffeeberry
Rhamnaceae	<i>Rhamnus crocea</i>	redberry
Rosaceae	<i>Adenostema fasciculatum</i>	chamise
Rosaceae	<i>Cercocarpus betuloides</i>	birch-leaf mountain mahogany
Rosaceae	<i>Fragaria vesca</i>	woodland strawberry
Rosaceae	<i>Heteromeles arbutifolia</i>	toyon
Rosaceae	<i>Holodiscus discolor</i>	Ocean spray
Rosaceae	<i>Oemleria cerasiformis</i>	Indian plum
Rosaceae	<i>Physocarpus capitatus</i>	Pacific ninebark

Family	Scientific name	Common name
Rosaceae	<i>Prunus emarginata</i>	bitter cherry
Rosaceae	<i>Prunus ilicifolius</i>	holly-leaf cherry
Rosaceae	<i>Rosa californica</i>	wild rose
Rosaceae	<i>Rosa gymnocarpa</i>	wood rose
Rosaceae	<i>Rubus discolor</i>	Himalayan blackberry
Rosaceae	<i>Rubus ursinus</i>	California blackberry
Rosaceae	<i>Sanguisorba minor ssp. muricata</i>	small burnet
Rubiaceae	<i>Galium porrigens</i>	climbing bedstraw
Rubiaceae	<i>Galium tricornutum</i>	rough bedstraw
Rubiaceae	<i>Galium aparine</i>	common bedstraw
Salicaceae	<i>Populus fremontii</i>	Fremont's cottonwood
Salicaceae	<i>Salix babylonica</i>	weeping willow
Salicaceae	<i>Salix laevigata</i>	red willow
Salicaceae	<i>Salix lasiolepis</i>	arroyo willow
Saxifragaceae	<i>Lithophragma heterophylla</i>	hillside woodland star
Scrophulariaceae	<i>Pedicularis densiflorus</i>	Indian warrior
Scrophulariaceae	<i>Antirrhinum kelloggii</i>	Kellogg's snapdragon
Scrophulariaceae	<i>Castilleja affinis</i>	indian paintbrush
Scrophulariaceae	<i>Castilleja densiflora ssp. densiflora</i>	dense owl's clover
Scrophulariaceae	<i>Castilleja exserta</i>	purple owl's clover
Scrophulariaceae	<i>Castilleja foliolosa</i>	woolly paintbrush
Scrophulariaceae	<i>Collinsia heterophylla</i>	Chinese houses
Scrophulariaceae	<i>Cordylanthus rigidus ssp. rigidus</i>	rigid bird's beak
Scrophulariaceae	<i>Keckiella cordifolia</i>	climbing penstemon
Scrophulariaceae	<i>Kickxia elatine</i>	sharp leaved fluellin
Scrophulariaceae	<i>Linaria maroccana</i>	Moroccan toad flax
Scrophulariaceae	<i>Mimulus aurantiacus</i>	bush monkey flower
Scrophulariaceae	<i>Penstemon centranthifolius</i>	scarlet bugler
Scrophulariaceae	<i>Penstemon heterophyllus ssp. heterophyllus</i>	foothill penstemon
Scrophulariaceae	<i>Scrophularia californica</i>	beeplant
Solanaceae	<i>Solanum elaeagnifolium</i>	silverleaf nightshade
Solanaceae	<i>Solanum umbelliferum</i>	blue witch nightshade
Solanaceae	<i>Datura stramonium</i>	jimson weed
Taxaceae	<i>Torreya californica</i>	California nutmeg
Taxodiaceae	<i>Sequoia sempervirens</i>	redwood
Typhaceae	<i>Typha angustifolia</i>	narrow-leafed cattail
Urticaceae	<i>Urtica dioica</i>	stinging nettle
Verbenaceae	<i>Verbena lasiostachys</i>	common vervain
Violaceae	<i>Viola ocellata</i>	two-eyed violet
Lichens		
Parmeliaceae	<i>Evernia prunastri</i>	oakmoss
Parmeliaceae	<i>Hypogymnia sp.</i>	tube lichen
Parmeliaceae	<i>Parmelia sp.</i>	none
Parmeliaceae	<i>Platismatia sp.</i>	ragbag
Parmeliaceae	<i>Usnea rubicunda</i>	red beard lichen
Ramalinaceae	<i>Ramalina menziesii</i>	lace lichen

APPENDIX C
REPRESENTATIVE SITE PHOTOGRAPHS



Top: Quarry boneyard (foreground) and Reclaimed slope (background)

Bottom: Non-native Annual Grassland habitat with substantial cover of native bunch grasses

Photographs taken February, 2009





Top: Mixed Scrub habitat

Bottom: Chamise Chaparral habitat

Photographs taken January, 2009 and June, 2008





Top: Poison Oak Scrub habitat

Bottom: Oak Woodland habitat

Photographs taken June, 2008



Attachment C
Delineation Report

Delineation of Potential Clean Water Act Section 404 Jurisdiction Permanente Quarry - East Materials Storage Area

CUPERTINO, SANTA CLARA COUNTY
CALIFORNIA

Prepared For:

Lehigh Southwest Cement Company
24001 Stevens Creek Blvd.
Cupertino CA, 95014-5659

Contact:

Mike Josselyn
josselyn@wra-ca.com

Geoff Smick
smick@wra-ca.com

Date:

April 2009



TABLE OF CONTENTS

1.0	INTRODUCTION	1
1.1	Study Background.....	1
1.2	Regulatory Background.....	1
2.0	SUMMARY OF POTENTIAL JURISDICTIONAL AREAS	1
3.0	METHODS	3
3.1	Potential Section 404 Waters of the U.S.	3
3.1.1	Wetlands.....	3
3.1.2	Other Waters of the U.S.	5
3.2	Difficult Wetland Situations in the Arid West	5
3.3	Areas Exempt from Section 404 Jurisdiction	5
4.0	RPA AREA DESCRIPTION	6
5.0	RESULTS	7
5.1	Potential Section 404 Waters of the U.S.	8
5.1.1	Wetlands.....	8
5.1.2	Other Waters of the U.S.	8
5.2	Areas Exempt from Section 404 Jurisdiction	8
6.0	POTENTIAL CORPS OF ENGINEERS JURISDICTION	8
7.0	REFERENCES	9

LIST OF FIGURES

Figure 1.	Location Map	2
-----------	--------------------	---

LIST OF APPENDICES

Appendix A - Map and Corps Arid West Data Sheets

Appendix B - Representative Photographs of the RPA Area

1.0 INTRODUCTION

1.1 Study Background

On January 21, 2009, WRA, Inc. (WRA) conducted a routine wetland delineation of an 89-acre portion of the Permanente Quarry (Quarry) that Lehigh Southwest Cement Company has proposed to include in the Quarry's Reclamation Plan Amendment (RPA) Area (Figure 1). The RPA Area is located west of Cupertino in Santa Clara County, California. The principal feature in the RPA Area is the East Materials Storage Area (EMSA), which stores overburden rock materials from mining operations in other parts of the Quarry. The purpose of the wetland delineation was to determine the presence of potential wetlands and waters subject to federal jurisdiction under Section 404 of the Clean Water Act. The wetland delineation is based on information available at the time of the study and on site conditions that were observed during the site visits. This report presents the results of the delineation.

1.2 Regulatory Background



Section 404 of the Clean Water Act

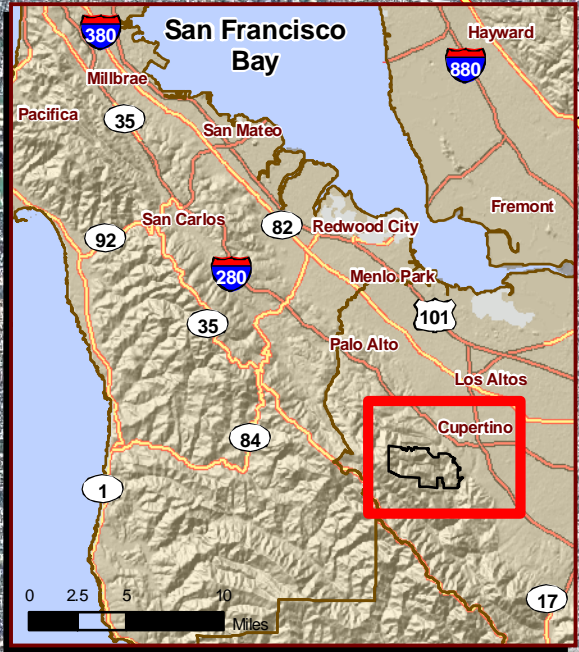
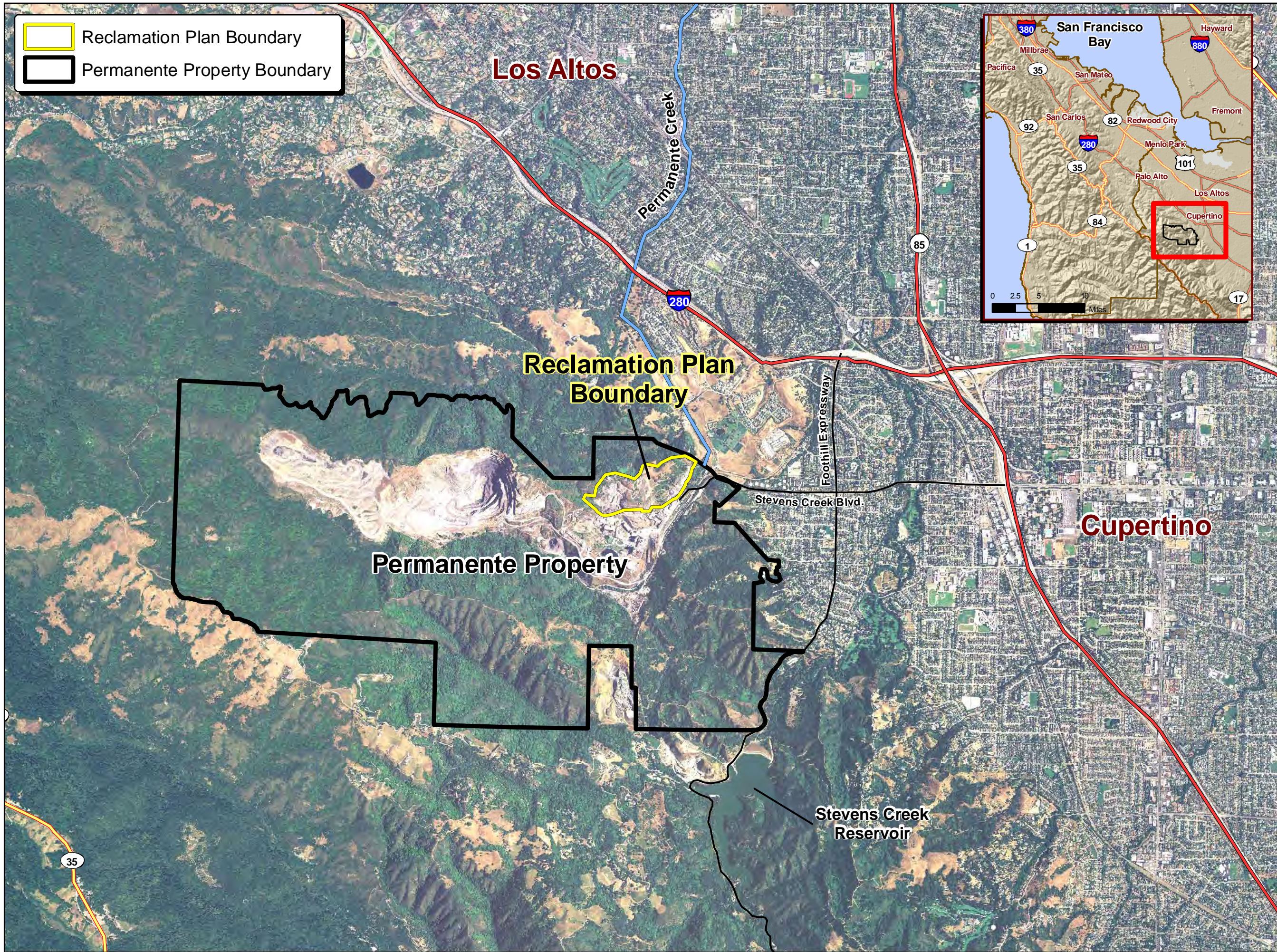
Section 404 of the Clean Water Act gives the U.S. Environmental Protection Agency (EPA) and the U.S. Army Corps of Engineers (Corps) regulatory and permitting authority regarding discharge of dredged or fill material into "navigable waters of the United States". Section 502(7) of the Clean Water Act defines navigable waters as "waters of the United States, including territorial seas." Section 328 of Chapter 33 in the Code of Federal Regulations defines the term "waters of the United States" as it applies to the jurisdictional limits of the authority of the Corps under the Clean Water Act. A summary of this definition of "waters of the U.S." in 33 CFR 328.3 includes (1) waters used for commerce; (2) interstate waters and wetlands; (3) "other waters" such as intrastate lakes, rivers, streams, and wetlands; (4) impoundments of waters; (5) tributaries to the above waters; (6) territorial seas; and (7) wetlands adjacent to waters. Therefore, for purposes of the determining Corps jurisdiction under the Clean Water Act, "navigable waters" as defined in the Clean Water Act are the same as "waters of the U.S." defined in the Code of Federal Regulations above.

The limits of Corps jurisdiction under Section 404 as given in 33 CFR Section 328.4 are as follows: (a) *Territorial seas*: three nautical miles in a seaward direction from the baseline; (b) *Tidal waters of the U.S.*: high tide line or to the limit of adjacent non-tidal waters; (c) *Non-tidal waters of the U.S.*: ordinary high water mark or to the limit of adjacent wetlands; (d) *Wetlands*: to the limit of the wetland.

2.0 SUMMARY OF POTENTIAL JURISDICTIONAL AREAS

No potential Section 404 jurisdictional areas were observed within the RPA Area. This determination is based on a wetland delineation conducted by WRA on January 21, 2009.

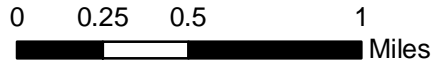
 Reclamation Plan Boundary
 Permanente Property Boundary



East Materials Storage Area,
Lehigh Permanente Quarry,
Santa Clara County,
California

Figure 1.

Reclamation Plan
Amendment
Location Map



3.0 METHODS

Prior to conducting field surveys, reference materials were reviewed, including the Soil Survey of the Santa Clara Area California (USDA 1958), the Cupertino and Redwood City U.S. Geological Survey (USGS) 7.5' quadrangle maps, and aerial photos of the site.

A focused evaluation of indicators of wetlands and waters was performed in the RPA Area on January 21, 2009. The methods used in this study to delineate jurisdictional wetlands and waters are based on the *U.S. Army Corps of Engineers Wetlands Delineation Manual* ("Corps Manual"; Environmental Laboratory 1987) and the *Interim Regional Supplement to the Corps of Engineers Wetland Delineation Manual: Arid West Region* ("Arid West Supplement"; Corps 2008). The routine method for wetland delineation described in the Corps Manual was used to identify areas potentially subject to Corps Section 404 jurisdiction within the RPA Area. A general description of the RPA Area, including plant communities present, topography, and land use was also generated during the delineation visits. The methods for evaluating the presence of wetlands and Other Waters of the U.S. employed during the site visit are described in detail below.

3.1 Potential Section 404 Waters of the U.S.

3.1.1 Wetlands

The RPA Area was evaluated for the presence or absence of indicators of the three wetland parameters described in the Corps Manual (Environmental Laboratory 1987) and Arid West Supplement (Corps 2008).

Section 328.3 of the Federal Code of Regulations defines wetlands as:

"Those areas that are inundated or saturated by surface or ground water at a frequency and duration sufficient to support, and that under normal circumstances do support, a prevalence of vegetation typically adapted for life in saturated soil conditions. Wetlands generally include swamps, marshes, bogs, and similar areas."

EPA, 40 CFR 230.3 and CE, 33 CFR 328.3 (b)

The three parameters used to delineate wetlands are the presence of: (1) hydrophytic vegetation, (2) wetland hydrology, and (3) hydric soils. According to the Corps Manual, for areas not considered "problem areas" or "atypical situations":

"...[E]vidence of a minimum of one positive wetland indicator from each parameter (hydrology, soil, and vegetation) must be found in order to make a positive wetland determination."

Data on vegetation, hydrology, and soils collected at sample points during the delineation site visit was reported on Arid West Supplement data forms. Once an area was determined to be a potential jurisdictional wetland, its boundaries were delineated using GPS equipment and mapped on a topographic map. The areas of potential jurisdictional wetlands were measured digitally using ArcGIS software. Indicators described in the Arid West Supplement were used to make wetland determinations at each sample point in the RPA Area and are summarized below.

Vegetation

Plant species identified on the RPA Area were assigned a wetland status according to the U.S. Fish and Wildlife Service list of plant species that occur in wetlands (Reed 1988). This wetland classification system is based on the expected frequency of occurrence in wetlands as follows:

OBL	Always found in wetlands	>99% frequency
FACW(±)	Usually found in wetlands	67-99%
FAC	Equal in wetland or non-wetlands	34-66%
FACU	Usually found in non-wetlands	1-33%
UPL/NL	Upland/Not listed (upland)	<1%

The Arid West Supplement requires that a field investigation be conducted to determine if hydrophytic vegetation is present. The most common procedure uses the “50/20 rule” (Indicator 1) described in the manual. To apply the “50/20 rule”, dominant species are chosen independently from each stratum of the community. In general, dominant species are determined for each vegetation stratum from a sampling plot of an appropriate size surrounding the sample point. In general, dominants are the most abundant species that individually or collectively account for more than 50 percent of the total vegetative cover in the stratum, plus any other species that, by itself, accounts for at least 20 percent of the total cover. If greater than 50 percent of the dominant species has an OBL, FACW, or FAC status, ignoring + and - qualifiers, the sample point meets the hydrophytic vegetation criterion.

Hydrology

The Corps jurisdictional wetland hydrology criterion is satisfied if an area is inundated or saturated for a period sufficient to create anoxic soil conditions during the growing season (a minimum of 14 consecutive days in the Arid West region). Evidence of wetland hydrology can include primary indicators, such as visible inundation or saturation, drift deposits, oxidized root channels, and salt crusts, or secondary indicators such as the FAC-neutral test, presence of a shallow aquitard, or crayfish burrows. The Arid West Supplement contains 16 primary hydrology indicators and 10 secondary hydrology indicators. Only one primary indicator is required to meet the wetland hydrology criterion; however, if secondary indicators are used, at least two secondary indicators must be present to conclude that an area has wetland hydrology.

The presence or absence of the primary or secondary indicators described in the Arid West Supplement was utilized to determine if sample points within the RPA Area met the wetland hydrology criterion.

Soils

The Natural Resource Conservation Service (NRCS) defines a hydric soil as follows:

“A hydric soil is a soil that formed under conditions of saturation, flooding, or ponding long enough during the growing season to develop anaerobic conditions in the upper part.”

Federal Register July 13, 1994,
U.S. Department of Agriculture, NRCS

Soils formed over long periods of time under wetland (anaerobic) conditions often possess characteristics that indicate they meet the definition of hydric soils. Hydric soils can have a hydrogen sulfide (rotten egg) odor, low chroma matrix color, generally designated 0, 1, or 2, used to identify them as hydric, presence of redox concentrations, gleyed or depleted matrix, or high organic matter content.

Specific indicators that can be used to determine whether a soil is hydric for the purposes of wetland delineation are provided in the NRCS *Field Indicators of Hydric Soils in the U.S.* (USDA 2006). The Arid West Supplement provides a list of 23 of these hydric soil indicators which are known to occur in the Arid West region. Soil samples were collected and described according to the methodology provided in the Arid West Supplement. Soil chroma and values were determined by utilizing a standard Munsell soil color chart (GretagMacbeth 2000).

Hydric soils were determined to be present if any of the soil samples met one or more of the 23 hydric soil indicators described in the Arid West Supplement.

3.1.2 Other Waters of the U.S.

This study also evaluated the presence of “Waters of the United States” other than wetlands potentially subject to U.S. Army Corps of Engineers jurisdiction under Section 404 of the Clean Water Act. Other areas, besides wetlands, subject to Corps jurisdiction include lakes, rivers and streams (including intermittent streams) in addition to all areas below the HTL in areas subject to tidal influence. Jurisdiction in non-tidal areas extends to the ordinary high water mark (OHW) defined as:

“...that line on the shore established by the fluctuations of water and indicated by physical characteristics such as clear, natural line impresses on the bank, shelving, changes in the characteristics of the soil, destruction of terrestrial vegetation, the presence of litter and debris, or other appropriate means that consider the characteristics of the surrounding areas.”

Federal Register Vol. 51, No. 219,
Part 328.3 (e). November 13, 1986

Identification of the ordinary high water mark followed the Corps Regulatory Guidance Letter No. 05-05, *Ordinary High Water Mark Identification* (Corps 2005).

The extent of any OHW marks were determined in the field and mapped using GPS when assessing the extent of potentially jurisdictional waters.

3.2 Difficult Wetland Situations in the Arid West

The Arid West Supplement (Corps 2008) includes procedures for identifying wetlands that may lack indicators due to natural processes (problem areas) or recent disturbances (atypical situations). “Problem area” wetlands are defined as naturally occurring wetland types that periodically lack indicators of hydrophytic vegetation, hydric soil, or wetland hydrology due to normal seasonal or annual variability. Some problem area wetlands may permanently lack certain indicators due to the nature of the soils or plant species on the site. “Atypical situations” are defined as wetlands in which vegetation, soil, or hydrology indicators are absent due to recent human activities or natural events.

3.3 Areas Exempt from Section 404 Jurisdiction

Some areas that meet the technical criteria for wetlands or Waters may not be jurisdictional under the Clean Water Act. Included in this category are some man-induced wetlands, which are areas that have developed at least some characteristics of naturally occurring wetlands due to either intentional or incidental human activities. Examples of man-induced wetlands may include, but are not limited to, irrigated wetlands, impoundments, or drainage ditches excavated in uplands, wetlands resulting from filling of formerly deep water habitats, dredged material disposal areas, and depressions within construction areas.

In addition, some isolated wetlands and waters may also be considered outside of Corps jurisdiction as a result of the Supreme Court's decision in *Solid Waste Agency of Northern Cook County (SWANCC) v. United States Army Corps of Engineers* (531 U.S. 159 (2001)). Isolated wetlands and waters are those areas that do not have a surface or groundwater connection to, and are not adjacent to a navigable "Waters of the U.S.", and do not otherwise exhibit an interstate commerce connection.

Based upon the 2006 U.S. Supreme Court decision in *Rapanos v. United States and Carabell v. United States* (collectively known as "Rapanos"), the Corps and the EPA issued guidance on the applicability of Section 404 jurisdiction (Corps 2007). Based on this guidance, Section 404 jurisdiction is applicable to traditional navigable waters (TNW), wetlands adjacent to TNWs, non-navigable tributaries of TNWs that are relatively permanent (RPWs)¹, and wetlands that abut such tributaries. Non-navigable tributaries that are not RPWs and wetlands adjacent to non-navigable tributaries that are not RPWs may also be jurisdictional, if a significant nexus exists between these waters and a TNW. The significant nexus evaluation includes an assessment of hydrological and ecological factors of any tributaries and adjacent wetlands to determine if these areas have more than an insubstantial or speculative effect on the physical, chemical and/or biological integrity of the TNW.

4.0 RPA AREA DESCRIPTION

The approximately 89-acre RPA Area is located in the northeast corner of the Quarry and includes the East Materials Storage Area (EMSA). The RPA Area is approximately 1/4 mile south of Rancho San Antonio County Park, at the west end of Permanente Road, approximately 4 miles west of downtown Cupertino in unincorporated Santa Clara County. The majority of the RPA Area is disturbed and unvegetated as it is an active part of the Quarry. Vegetated areas are a patchwork of natural communities supporting small areas of mixed oak woodlands, coyote brush scrub, California annual grassland and areas that have been reclaimed from past disturbance.

Vegetation

Vegetation communities within upland portions of the RPA Area consists primarily of non-native annual grassland, ruderal/disturbed herbaceous and woody vegetation, and highly disturbed areas. Scattered patches of oak woodland and chaparral area also present. Vegetation communities are discussed in detail in the EMSA Biological Resources Assessment Report (WRA 2009).

Hydrology

Natural hydrological sources for the RPA Area include direct precipitation and surface run-off from adjacent lands. No USGS blue-line streams are present in the RPA Area nor do any discharge to the RPA Area. Two upland drainages in the upper watershed convey flows to the RPA Area, but terminate in active quarry facilities and do not exit the RPA Area. Overland flows from most of the RPA Area drain into Permanente Creek via a culvert and through an erosional gully located in the far eastern portion of the RPA Area. Overland flows originating in the far northern portion of the RPA Area drain to the north, and enter Permanente Creek via an

¹RPWs are defined as tributaries that flow year round or have continuous flow at least seasonally (typically 3 months) (Corps 2007).

unnamed USGS blue-line stream to the north of the RPA Area boundary. Permanente Creek flows generally northwards where it receives flows from Hale Creek in Mountain View before reaching Mountain View Slough and South San Francisco Bay.

Soils

The USDA Soil Survey (USDA 1958) indicates that the RPA Area has four mapped soil types: pit, Los Gatos clay loam, 20-35 percent, Los Gatos - Maymen stony soils, undifferentiated, 50+ percent slopes, Soper gravelly loam, 20-35 percent slopes. None of these soils are listed as hydric on the National List of Hydric Soils (USDA 2005). However, due to the historic deposition of waste rock and the disturbance of the native soils in this area, these soil types are likely not representative of current conditions within the RPA Area. The best characterization of the soil type is:

Pit - This mapping unit consists of areas large enough to map where excavations have been made and where the original soil has been removed.

The underlying native soil types are described below.

Los Gatos clay loam, 20-35 percent slopes - The Los Gatos surface soils are brown and become nearly reddish brown when moist. They grade into brown or reddish brown subsoil of clay loam texture. In most places some rock fragments occur in the subsoils. The number and size of fragments increase with depth. The soils are underlain by hard but generally broken or shattered metamorphosed sedimentary rock at depths of 26 to 38 inches.

Los Gatos - Maymen stony soils, undifferentiated, 50+ percent slopes - One of the most extensive mapping units in the Santa Clara Area Soil Survey consists of very steep and stony areas of Los Gatos and Maymen soils. Slopes are steep, and in most places rock outcrops are numerous. The vegetation is a dense growth of brush. The Los Gatos soils predominate, but in some places fairly large areas of Maymen soils occur. Because of the very steep and stony surface and the dense brush cover, no attempt was made to map the soils separately.

Soper gravelly loam, 20-35 percent slopes - The surface soil is a brown or light-brown, slightly or medium acid gravelly loam to depths of 8 to 13 inches. The surface soil grades into a slightly more reddish-brown, moderately compact, weakly blocky subsoil of gravelly clay loam texture. The subsoil retards drainage somewhat and causes waterlogging of the surface soil during heavy rains. At depths of 23 to 32 inches the subsoil grades into a noncalcareous moderately or weakly consolidated conglomerate bedrock that is somewhat more permeable than the subsoil.

5.0 RESULTS

The RPA Area was inspected by examination of aerial photography and by walking throughout. No wetlands or waters potentially jurisdictional under Section 404 of the Clean Water Act were observed within the RPA Area. Vegetation, soils and hydrology data collected during the delineation site visit are presented in Appendix A on standard Corps Arid West Region data forms. Photos of representative portions of the RPA Area and sample points are shown in Appendix B.

Non-jurisdictional erosion gullies were present in the waste rock piles and surrounding areas, but none were determined to qualify as "waters of the US". One man-made settling basin was mapped within the RPA Area.

5.1 Potential Section 404 Waters of the U.S.

5.1.1 Wetlands

No potential jurisdictional wetlands were observed in the RPA Area.

5.1.2 Other Waters of the U.S.

Presence of any OHW marks was investigated in the field survey. None were observed. Erosion gullies were present in the waste rock deposits, however, erosion gullies are not considered jurisdictional under guidance from the Corps of Engineers (May 2007).

5.2 Areas Exempt from Section 404 Jurisdiction

The RPA Area has been highly modified due to its use as a materials storage area in support of Quarry activities and contains one man-made settling basin that is not subject to Corps jurisdiction under Section 404 of the CWA because it is a settling basin constructed in uplands.

Settling Basin

One man-made basin totaling approximately 0.04 acre was mapped within the RPA Area (Appendix A). This basin was constructed in uplands apparently to trap runoff from the placement of quarry soil and rock overburden material within the EMSA. The basin captured silt-laden runoff as designed, and some hydrophytic plants have grown in past years. During the site visit, dead vegetation consisting of narrow-leaf cattail (*Typha angustifolia*, OBL) was present, but appears to have been covered in with near sediment deposits. No new growth of cattails were observed at the time of the delineation indicating that the basin is silting in and becoming drier in character.

Problematic hydric soils are present within the sedimentation basin. The deposition of sediment into the basin appears to occur at a rate sufficient to obscure or prevent the formation of hydric soil indicators. Because both dominant hydrophytic vegetation and indicators of wetland hydrology are present within the basin, problematic hydric soils are assumed present.

Settling basins are specifically excluded from the regulation under the Clean Water Act as follows:

Artificial lakes or ponds created by excavating and/or diking dry land to collect and retain water and which are used exclusively for such purposes as stock watering, irrigation, settling basins, or rice growing.

Section 328.3 Definitions

6.0 POTENTIAL CORPS OF ENGINEERS JURISDICTION

No wetlands or other waters that may be considered jurisdictional under Section 404 of the Clean Water Act were observed within the East Materials Storage Area RPA Area. The conclusion of this delineation is based on conditions observed at the time of the field survey conducted on January 21, 2009.

7.0 REFERENCES

- Environmental Laboratory. 1987. Corps of Engineers Wetlands Delineation Manual. Department of the Army, Waterways Experiment Station, Vicksburg, Mississippi 39180-0631.
- Federal Register. November 13, 1986. Department of Defense, Corps of Engineers, Department of the Army, 33 CFR Parts 320 through 330, Regulatory Programs of the Corps of Engineers; Final Rule. Vol. 51, No. 219; page 41217.
- GretagMacBeth. 2000. Munsell Soil Color Charts, revised washable edition.
- Hickman, J.C. (ed.) 1993. The Jepson manual: higher plants of California. University of California Press.
- Reed, P. B., Jr. 1988. National list of plant species that occur in wetlands: California (Region 0). U.S. Fish and Wildlife Service Biological Report 88 (26.10).
- U.S. Army Corps of Engineers (Corps). 2005. Regulatory Guidance Letter No. 05-05. Ordinary High Water Mark Identification. December 7.
- U.S. Army Corps of Engineers (Corps). 2007. Jurisdictional Determination Form Instructional Guidebook. May.
- U.S. Army Corps of Engineers (Corps). 2008. Regional Supplement to the Corps of Engineers Wetland Delineation Manual: Arid West Region (Version 2.0). September.
- U.S. Department of Agriculture, Natural Resources Conservation Service (USDA). 1958. Soil Survey of Santa Clara Area, California. In cooperation with the University of California Agricultural Experiment Station.
- U.S. Department of Agriculture, Natural Resources Conservation Service (USDA). 2005. Official List of US Hydric Soils.
- U.S. Department of Agriculture, Natural Resources Conservation Service (USDA). 2006. Field Indicators of Hydric Soils in the United States: A Guide for Identifying and Delineating Hydric Soils, Version 6.0. In cooperation with the National Technical Committee for Hydric Soils, U.S. Army Corps of Engineers.
- U.S. Geological Survey (USGS). 1991. Cupertino. 7.5 minute topographic map.
- U.S. Geological Survey (USGS). 1991. Redwood City. 7.5 minute topographic map.
- WRA, Inc. (WRA). 2009. Biological Resources Assessment for the Permanente Quarry East Materials Storage Area, Cupertino, Santa Clara County, California.

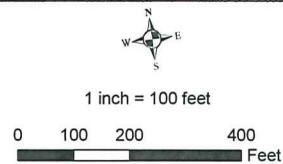
APPENDIX A
MAP AND CORPS ARID WEST DATA SHEETS



- Reclamation Plan Boundary
- Sample Points
- Non-jurisdictional Settling Basin (0.04 acres)

Appendix A. Section 404 Jurisdictional Determination

East Materials Storage Area
 Lehigh Permanente Quarry
 Santa Clara County, CA



Date: April 2009
 Map By: Michael Rochelle
 Image Date: April 2007
 Filepath: I:\Acad2000\16000\16143\gis\Arcmap\Delin\EMSA\AppendixA_3.mxd

Wetland Determination Data Form - Arid West Region

Project/Site East Materials Storage Area City Cupertino County Santa Clara Sampling Date 1/21/2009
 Applicant/Owner Hanson Permanente Cement Inc. State CA Sampling Point SP 01
 Investigator(s) WRA, Inc., M. Trieger, R. Wilson Section, Township, Range T07S R02W Section 16 SW 1/4
 Landform (hillslope, terrace, etc.) basin Local Relief (concave, convex, none) concave Slope(%) <1%
 Subregion(LRR) LRR C (Medit. CA) Lat: 122 5' 21.03" W Long: 37 19' 22.15" N Datum: WGS 84
 Soil Map Unit Name Soper gravelly loam, 20-35% slopes NWI classification none

Are climatic/hydrologic conditions on-site typical for this time of year? Yes No (If no, explain in remarks)
 Are any of the following significantly disturbed? Vegetation Soil Hydrology Are "Normal Circumstances" present? Yes No
 Are any of the following naturally problematic? Vegetation Soil Hydrology (If needed, explain any answers in remarks)

SUMMARY OF FINDINGS - Attach site map showing sample point locations, transects, important features, etc.

Hydrophytic Vegetation Present? <input checked="" type="checkbox"/> Yes <input type="checkbox"/> No Hydric Soil Present? <input checked="" type="checkbox"/> Yes <input type="checkbox"/> No Wetland Hydrology Present? <input checked="" type="checkbox"/> Yes <input type="checkbox"/> No	Is the Sampled Area within a Wetland? <input checked="" type="checkbox"/> Yes <input type="checkbox"/> No
---	---

Remarks: Sample point is located in a detention basin. The basin is gradually filling in with sediment runoff from adjacent lands. The basin displays dominant hydrophytic vegetation, indicators of wetland hydrology, and problematic hydric soils.

VEGETATION

Tree stratum (use scientific names)	Absolute % cover	Dominant Species?	Indicator Status	Dominance Test Worksheet
1. _____	_____	_____	_____	Number of Dominant Species that are OBL, FACW, or FAC? <u>2</u> (A)
2. _____	_____	_____	_____	Total number of dominant species across all strata? <u>3</u> (B)
3. _____	_____	_____	_____	% of dominant species that are OBL, FACW, or FAC? <u>67</u> (A/B)
4. _____	_____	_____	_____	
Tree Stratum Total Cover: 0				
Sapling/Shrub Stratum				Prevalence Index Worksheet
1. _____	_____	_____	_____	Total % cover of: _____ Multiply by: _____
2. _____	_____	_____	_____	OBL species _____ x1 _____
3. _____	_____	_____	_____	FACW species _____ x2 _____
4. _____	_____	_____	_____	FAC species _____ x3 _____
Sapling/Shrub Stratum Total Cover: 0				FACU species _____ x4 _____
Herb Stratum				UPL species _____ x5 _____
1. <u>Typha angustifolia</u>	<u>15</u>	<u>Yes</u>	<u>OBL</u>	Column Totals _____ (A) _____ (B)
2. <u>Dittrichia graveolens</u>	<u>10</u>	<u>Yes</u>	<u>NL</u>	Prevalence Index = B/A = _____
3. <u>Polypogon monspeliensis</u>	<u>7</u>	<u>Yes</u>	<u>FACW+</u>	
4. _____	_____	_____	_____	
5. _____	_____	_____	_____	
6. _____	_____	_____	_____	
7. _____	_____	_____	_____	
8. _____	_____	_____	_____	
Herb Stratum Total Cover: 32				
Woody Vine Stratum				
1. _____	_____	_____	_____	
2. _____	_____	_____	_____	
Woody Vine Stratum Total Cover: 0				
% Bare ground in herb stratum <u>68</u> % cover of biotic crust <u>0</u>				Hydrophytic Vegetation Present ? <input checked="" type="checkbox"/> Yes <input type="checkbox"/> No

Remarks: Hydrophytic vegetation is dominant at sample point.

SOIL

Sampling Point SP 01

Profile description: (Describe to the depth needed to document the indicator or confirm the absence of indicators.)								
Depth (inches)	Matrix		Redox Features				Texture	Remarks
	Color (moist)	%	Color (moist)	%	Type ¹	Loc ¹		
0-1	2.5Y 3/2	100	n/a				clay	sediment infill
1-2	2.5Y 4/2	100	n/a				sand	sediment infill
2-4	10YR 4/1	100	n/a				clay	sediment infill
4-7	10YR 4/1	100	n/a				sand	sediment infill
7-11	10YR 2/1	100	n/a				gravelly loam	sediment infill
11-15	2.5Y 4/2	100	n/a				clay	sediment infill

¹Type: C=Concentration, D=Depletion, RM=Reduced Matrix. ²Location: PL=Pore Lining, RC=Root Channel, M=Matrix

Hydric Soil Indicators: (Applicable to all LRRs, unless otherwise noted.) <input type="checkbox"/> Histosol (A1) <input type="checkbox"/> Sandy Redox (S5) <input type="checkbox"/> Histic Epipedon (A2) <input type="checkbox"/> Stripped Matrix (S6) <input type="checkbox"/> Black Histic (A3) <input type="checkbox"/> Loamy Mucky Mineral (F1) <input type="checkbox"/> Hydrogen Sulfide (A4) <input type="checkbox"/> Loamy Gleyed Matrix (F2) <input type="checkbox"/> Stratified Layers (A5)(LRR C) <input type="checkbox"/> Depleted Matrix (F3) <input type="checkbox"/> 1cm Muck (A9)(LRR D) <input type="checkbox"/> Redox Dark Surface (F6) <input type="checkbox"/> Depleted Below Dark Surface (A11) <input type="checkbox"/> Depleted Dark Surface (F7) <input type="checkbox"/> Thick Dark Surface (A12) <input type="checkbox"/> Redox Depressions (F8) <input type="checkbox"/> Sandy Mucky Mineral (S1) <input type="checkbox"/> Vernal Pools (F9) <input type="checkbox"/> Sandy Gleyed Matrix (S4)			Indicators for Problematic Hydric Soils³: <input type="checkbox"/> 1cm Muck (A9) (LRR C) <input type="checkbox"/> 2cm Muck (A10)(LRR B) <input type="checkbox"/> Reduced Vertic (F18) <input type="checkbox"/> Red Parent Material (TF2) <input checked="" type="checkbox"/> Other (explain in remarks)
---	--	--	--

³Indicators of hydric vegetation and wetland hydrology must be present.

Restrictive Layer (if present): Type: <u>none</u> Depth (inches): <u>n/a</u>	Hydric Soil Present ? <input checked="" type="checkbox"/> Yes <input type="checkbox"/> No
---	--

Remarks: Problematic hydric soils present at sample point. Wetland is a sedimentation basin within the quarry operations area that is gradually filling in. Deposition of sediment appears to occur at a rate sufficient to obscure or prevent the formation of hydric soil indicators.

HYDROLOGY

Wetland Hydrology Indicators: Primary Indicators (any one indicator is sufficient) <input type="checkbox"/> Surface Water (A1) <input type="checkbox"/> Salt Crust (B11) <input type="checkbox"/> High Water Table (A2) <input type="checkbox"/> Biotic Crust (B12) <input type="checkbox"/> Saturation (A3) <input type="checkbox"/> Aquatic Invertebrates (B13) <input type="checkbox"/> Water Marks (B1)(Nonriverine) <input type="checkbox"/> Hydrogen Sulfide Odor (C1) <input checked="" type="checkbox"/> Sediment Deposits (B2)(Nonriverine) <input checked="" type="checkbox"/> Oxidized Rhizospheres along Living Roots (C3) <input type="checkbox"/> Drift Deposits (B3)(Nonriverine) <input type="checkbox"/> Presence of Reduced Iron (C4) <input checked="" type="checkbox"/> Surface Soil Cracks (B6) <input type="checkbox"/> Recent Iron Reduction in PLoWed Soils (C6) <input type="checkbox"/> Inundation Visible on Aerial Imagery (B7) <input type="checkbox"/> Other (Explain in Remarks) <input type="checkbox"/> Water-Stained Leaves (B9)	Secondary Indicators (2 or more required) <input type="checkbox"/> Water Marks (B1)(Riverine) <input type="checkbox"/> Sediment Deposits (B2)(Riverine) <input type="checkbox"/> Drift Deposits (B3)(Riverine) <input type="checkbox"/> Drainage Patterns (B10) <input type="checkbox"/> Dry-Season Water Table (C2) <input type="checkbox"/> Thin Muck Surface (C7) <input type="checkbox"/> Crayfish Burrows (C8) <input type="checkbox"/> Saturation Visible on Aerial Imagery (C9) <input type="checkbox"/> Shallow Aquitard (D3) <input type="checkbox"/> FAC-Neutral Test (D5)
---	--

Field Observations: Surface water present? <input type="checkbox"/> Yes <input checked="" type="checkbox"/> No Depth (inches): _____ Water table present? <input type="checkbox"/> Yes <input checked="" type="checkbox"/> No Depth (inches): _____ Saturation Present? <input type="checkbox"/> Yes <input checked="" type="checkbox"/> No Depth (inches): _____ (includes capillary fringe)	Wetland Hydrology Present ? <input checked="" type="checkbox"/> Yes <input type="checkbox"/> No
--	--

Describe recorded data (stream gauge, monitoring well, aerial photos, etc.) if available.

Remarks: Sample point displays indicators of wetland hydrology including sediment deposits (B2), surface soil cracks (B6), and oxidized rhizospheres along living roots (C3).

Wetland Determination Data Form - Arid West Region

Project/Site East Materials Storage Area City Cupertino County Santa Clara Sampling Date 1/21/2009
 Applicant/Owner Hanson Permanente Cement Inc. State CA Sampling Point SP 02
 Investigator(s) WRA, Inc., M. Trieger, R. Wilson Section, Township, Range T07S R02W Section 16 SW 1/4
 Landform (hillslope, terrace, etc.) hillslope Local Relief (concave, convex, none) none Slope(%) 2%
 Subregion(LRR) LRR C (Medit. CA) Lat: 122 5' 21.16" W Long: 37 19' 22.04" N Datum: WGS 84
 Soil Map Unit Name Soper gravelly loam, 20-35% slopes NWI classification none

Are climatic/hydrologic conditions on-site typical for this time of year? Yes No (If no, explain in remarks)
 Are any of the following significantly disturbed? Vegetation Soil Hydrology Are "Normal Circumstances" present? Yes No
 Are any of the following naturally problematic? Vegetation Soil Hydrology (If needed, explain any answers in remarks)

SUMMARY OF FINDINGS - Attach site map showing sample point locations, transects, important features, etc.

Hydrophytic Vegetation Present? <input type="checkbox"/> Yes <input checked="" type="checkbox"/> No Hydric Soil Present? <input type="checkbox"/> Yes <input checked="" type="checkbox"/> No Wetland Hydrology Present? <input type="checkbox"/> Yes <input checked="" type="checkbox"/> No	Is the Sampled Area within a Wetland? <input type="checkbox"/> Yes <input checked="" type="checkbox"/> No
---	---

Remarks: Sample point is located in uplands. Sample point is located upslope from the detention basin. Fill soils are present at the sample point.

VEGETATION

Tree stratum (use scientific names)	Absolute % cover	Dominant Species?	Indicator Status	Dominance Test Worksheet
1. _____	_____	_____	_____	Number of Dominant Species that are OBL, FACW, or FAC? <u>0</u> (A) Total number of dominant species across all strata? <u>1</u> (B) % of dominant species that are OBL, FACW, or FAC? <u>0</u> (A/B)
2. _____	_____	_____	_____	
3. _____	_____	_____	_____	
4. _____	_____	_____	_____	
Tree Stratum Total Cover: 0				Prevalence Index Worksheet Total % cover of: _____ Multiply by: _____ OBL species _____ x1 _____ FACW species _____ x2 _____ FAC species _____ x3 _____ FACU species _____ x4 _____ UPL species _____ x5 _____ Column Totals _____ (A) _____ (B) Prevalence Index = B/A = _____
<u>Sapling/Shrub Stratum</u>				
1. _____	_____	_____	_____	
2. _____	_____	_____	_____	
3. _____	_____	_____	_____	
4. _____	_____	_____	_____	
Sapling/Shrub Stratum Total Cover: 0				
<u>Herb Stratum</u>				
1. <u>Dittrichia graveolens</u>	<u>20</u>	<u>Yes</u>	<u>NL</u>	
2. <u>Trifolium sp.</u>	<u>2</u>	<u>No</u>	_____	
3. _____	_____	_____	_____	
4. _____	_____	_____	_____	
5. _____	_____	_____	_____	
6. _____	_____	_____	_____	
7. _____	_____	_____	_____	
8. _____	_____	_____	_____	
Herb Stratum Total Cover: 22				
<u>Woody Vine Stratum</u>				
1. _____	_____	_____	_____	
2. _____	_____	_____	_____	
Woody Vine Stratum Total Cover: 0				
% Bare ground in herb stratum <u>78</u> % cover of biotic crust <u>0</u>				Hydrophytic Vegetation Present ? <input type="checkbox"/> Yes <input checked="" type="checkbox"/> No

Remarks: Upland vegetation is dominant at sample point.

SOIL

Sampling Point SP 02

Profile description: (Describe to the depth needed to document the indicator or confirm the absence of indicators.)								
Depth (inches)	Matrix		Redox Features				Texture	Remarks
	Color (moist)	%	Color (moist)	%	Type ¹	Loc ¹		
0-4	10YR 2/1	20	n/a				clay, gravel	gravelly fill material
0-4	gravel	80	n/a				gravel	gravel to 1" diameter

¹Type: C=Concentration, D=Depletion, RM=Reduced Matrix. ²Location: PL=Pore Lining, RC=Root Channel, M=Matrix

Hydric Soil Indicators: (Applicable to all LRRs, unless otherwise noted.)			Indicators for Problematic Hydric Soils ³ :
<input type="checkbox"/> Histosol (A1)	<input type="checkbox"/> Sandy Redox (S5)	<input type="checkbox"/> 1cm Muck (A9) (LRR C)	<input type="checkbox"/> 2cm Muck (A10)(LRR B) <input type="checkbox"/> Reduced Vertic (F18) <input type="checkbox"/> Red Parent Material (TF2) <input type="checkbox"/> Other (explain in remarks)
<input type="checkbox"/> Histic Epipedon (A2)	<input type="checkbox"/> Stripped Matrix (S6)	<input type="checkbox"/> 1cm Muck (A9)(LRR D)	
<input type="checkbox"/> Black Histic (A3)	<input type="checkbox"/> Loamy Mucky Mineral (F1)	<input type="checkbox"/> Depleted Below Dark Surface (A11)	
<input type="checkbox"/> Hydrogen Sulfide (A4)	<input type="checkbox"/> Loamy Gleyed Matrix (F2)	<input type="checkbox"/> Thick Dark Surface (A12)	
<input type="checkbox"/> Stratified Layers (A5)(LRR C)	<input type="checkbox"/> Depleted Matrix (F3)	<input type="checkbox"/> Sandy Mucky Mineral (S1)	
<input type="checkbox"/> 1cm Muck (A9)(LRR D)	<input type="checkbox"/> Redox Dark Surface (F6)	<input type="checkbox"/> Sandy Gleyed Matrix (S4)	
<input type="checkbox"/> Depleted Below Dark Surface (A11)	<input type="checkbox"/> Redox Dark Surface (F7)		
<input type="checkbox"/> Thick Dark Surface (A12)	<input type="checkbox"/> Redox Depressions (F8)		
<input type="checkbox"/> Sandy Mucky Mineral (S1)	<input type="checkbox"/> Vernal Pools (F9)		
<input type="checkbox"/> Sandy Gleyed Matrix (S4)			

³Indicators of hydric vegetation and wetland hydrology must be present.

Restrictive Layer (if present): Type: <u>compact gravel fill</u> Depth (inches): <u>4"</u>	Hydric Soil Present ? <input type="checkbox"/> Yes <input checked="" type="checkbox"/> No
---	---

Remarks: Hydric soils not present at sample point. Could not examine soils below 4" due to impenetrable compacted gravel layer.

HYDROLOGY

Wetland Hydrology Indicators:	Secondary Indicators (2 or more required)
Primary Indicators (any one indicator is sufficient) <ul style="list-style-type: none"> <input type="checkbox"/> Surface Water (A1) <input type="checkbox"/> High Water Table (A2) <input type="checkbox"/> Saturation (A3) <input type="checkbox"/> Water Marks (B1)(Nonriverine) <input type="checkbox"/> Sediment Deposits (B2)(Nonriverine) <input type="checkbox"/> Drift Deposits (B3)(Nonriverine) <input type="checkbox"/> Surface Soil Cracks (B6) <input type="checkbox"/> Inundation Visible on Aerial Imagery (B7) <input type="checkbox"/> Water-Stained Leaves (B9) <input type="checkbox"/> Salt Crust (B11) <input type="checkbox"/> Biotic Crust (B12) <input type="checkbox"/> Aquatic Invertebrates (B13) <input type="checkbox"/> Hydrogen Sulfide Odor (C1) <input type="checkbox"/> Oxidized Rhizospheres along Living Roots (C3) <input type="checkbox"/> Presence of Reduced Iron (C4) <input type="checkbox"/> Recent Iron Reduction in PLoWed Soils (C6) <input type="checkbox"/> Other (Explain in Remarks) 	<ul style="list-style-type: none"> <input type="checkbox"/> Water Marks (B1)(Riverine) <input type="checkbox"/> Sediment Deposits (B2)(Riverine) <input type="checkbox"/> Drift Deposits (B3)(Riverine) <input type="checkbox"/> Drainage Patterns (B10) <input type="checkbox"/> Dry-Season Water Table (C2) <input type="checkbox"/> Thin Muck Surface (C7) <input type="checkbox"/> Crayfish Burrows (C8) <input type="checkbox"/> Saturation Visible on Aerial Imagery (C9) <input type="checkbox"/> Shallow Aquitard (D3) <input type="checkbox"/> FAC-Neutral Test (D5)

Field Observations: Surface water present? <input type="checkbox"/> Yes <input checked="" type="checkbox"/> No Depth (inches): _____ Water table present? <input type="checkbox"/> Yes <input checked="" type="checkbox"/> No Depth (inches): _____ Saturation Present? <input type="checkbox"/> Yes <input checked="" type="checkbox"/> No Depth (inches): _____ (includes capillary fringe)	Wetland Hydrology Present ? <input type="checkbox"/> Yes <input checked="" type="checkbox"/> No
---	---

Describe recorded data (stream gauge, monitoring well, aerial photos, etc.) if available.

Remarks: No indicators of wetland hydrology present at sample point.

APPENDIX B
REPRESENTATIVE PHOTOGRAPHS OF THE RPA AREA



Top: Sample point SP 01 is located within this sedimentation basin that is gradually filling in and currently supports hydrophytic vegetation.
Bottom (L, R): Two examples of non-jurisdictional erosional features downstream of the sedimentation basin pictured above.

Photographs taken July 2008 (top), January 21, 2009



Attachment D

Erosion Control Plan Report

EROSION CONTROL PLAN REPORT
FOR
PERMANENTE QUARRY
EAST MATERIALS STORAGE AREA

April 16, 2009

Wayne W. Chang, MS, PE 46548

ChangConsultants

Civil Engineering • Hydrology • Hydraulics • Sedimentation

P.O. Box 9496
Rancho Santa Fe, CA 92067
(858) 692-0760

FOR REVIEW ONLY

TABLE OF CONTENTS

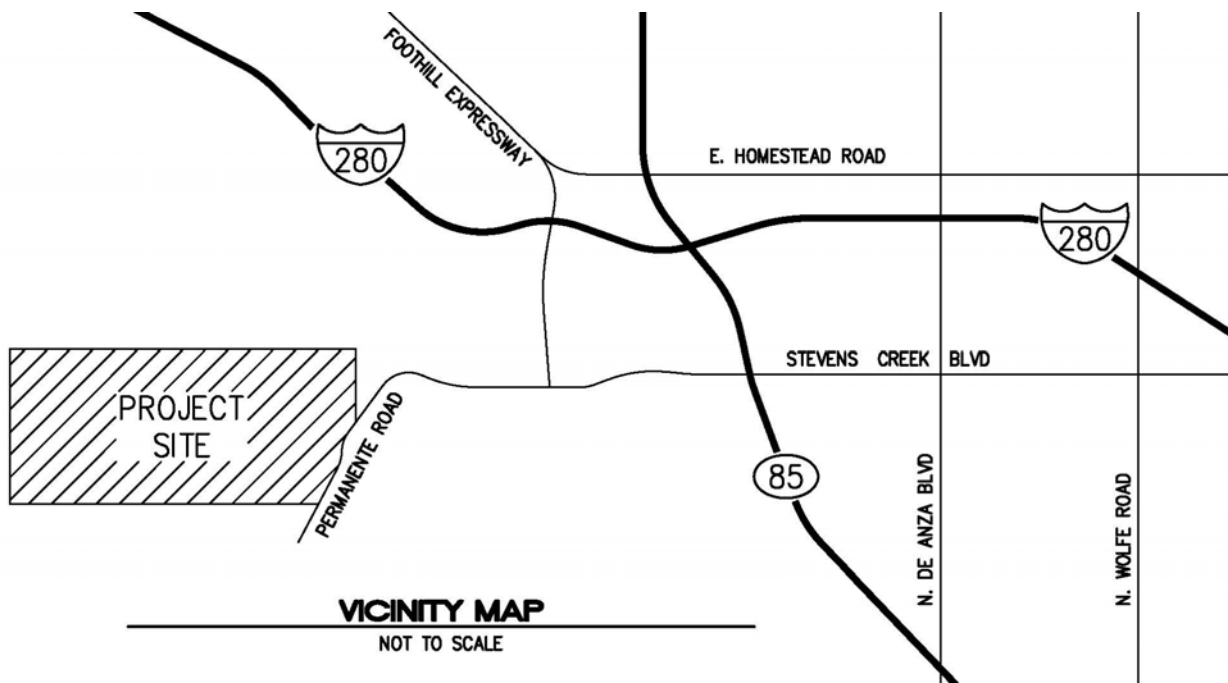
Introduction.....	1
Temporary Erosion Control Measures.....	2
Permanent Erosion Control Measures	3
Conclusion	6

MAP POCKET

- Erosion Control Measures 1-Year Following Reclamation Completion
- Erosion Control Measures Following Final Revegetation Exhibit

INTRODUCTION

Lehigh Southwest Cement Company operates the Permanente Quarry, which is located west of the city of Cupertino in Santa Clara County (see the Vicinity Map). Quarrying operations have occurred at the site since the early 1900's. This report is for a portion of the site known as the East Materials Storage Area (EMSA). This report has been prepared for the proposed activities in the EMSA. The EMSA is a large fill area primarily used for storing overburden material. The EMSA will generally be reclaimed with 2 to 1 (horizontal to vertical) inter-bench slopes (approximately 2.6 to 1 slope overall), and be constructed from an elevation of just over 550 feet to just over 900 feet. Benches will lie at approximately 40-foot vertical intervals, and a perimeter road will be graded around the EMSA. A series of drainage ditches and swales will serve the EMSA. The EMSA slopes will be reclaimed with native grasses and shrubs. The north and east facing benches will also contain trees (oaks), while the south facing benches will contain some pines. The uppermost pad area will be planted with grasses, shrubs, and some trees (pines).



This report contains the erosion control plan for the EMSA. The State Water Resources Control Board (SWRCB), Regional Water Quality Control Board (RWQCB), Santa Clara Valley Urban Runoff Pollution Prevention Program (SCVURPPP), and Surface Mining and Reclamation Act (SMARA) require best management practices to control erosion. This erosion control plan has been prepared to meet the requirements of these agencies. Initially, temporary erosion control measures will be installed during the course of reclamation activities. The measures will include hydroseeding, desiltation basins, silt fencing, and drainage conveyance facilities. The temporary measures will be installed as reclamation occurs and are anticipated to remain in place until approximately one year following completion of reclamation. After this point, the revegetation throughout the EMSA will begin to establish. Approximately three years after reclamation, the final revegetation is anticipated to be completely

established and the temporary erosion control measures will no longer be necessary. The desiltation basins, silt fencing, and other temporary measures will be removed, and only the permanent revegetation and drainage controls will remain. The following discusses the temporary and permanent measures that form the erosion control plan for the EMSA.

TEMPORARY EROSION CONTROL MEASURES

During the course of and immediately following reclamation, temporary erosion control measures will be used at the site. The primary water quality pollutant generated from the EMSA will be sediment. Consequently, the temporary measures must focus on sediment control. The measures are illustrated on the “Erosion Control Measures 1-Year Following Reclamation Completion” exhibit in the map pocket, and include hydroseeding, desiltation basins, silt fencing, and drainage ditches.

Hydroseeding will be used on the reclaimed slopes, benches, and pads. The seed mix has been specified in the April 2009 Reclamation Plan. The preliminary erosion control stage incorporated prior to the revegetation tasks will consist of the native seed mix shown in Table 1. The mix includes species that have proven successful in other revegetation efforts in the quarry, and are recommended to provide erosion control and initial establishment of native grasses and herbaceous species until a more specific revegetation plan is developed based on test plot data and plant and seed availability.

Table 1. Proposed erosion control seed mix.		
SCIENTIFIC NAME	COMMON NAME	PURE LIVE SEED (lb /acre)
<i>Bromus carinatus</i>	California brome	16.00
<i>Elymus glaucus</i>	blue wildrye	10.00
<i>Lupinus nanus</i>	sky lupine (innoc.)	5.00
<i>Nassella pulchra</i>	purple needlegrass	8.00
<i>Plantago erecta</i>	California plantain	3.00
<i>Trifolium wildenovii</i>	tomcat clover (innoc.)	3.00
<i>Vulpia microstachys</i>	three weeks fescue	8.00
TOTAL		53.00

A series of desiltation basins and silt fencing will also be installed around the perimeter of the EMSA. The silt fencing is shown in light blue and the desiltation basins are highlighted in yellow on the “1-Year” exhibit in the map pocket. Silt fencing and desiltation basin details are included on the exhibit. The silt fencing will generally be placed at the toe of the perimeter 2 to 1 (horizontal to vertical) slopes to prevent sediment from being conveyed beyond the EMSA. Straw waddles can be used as an alternative to silt fences on slopes that are 3 to 1 or flatter. The straw waddles should be installed along the toe of the slopes as well as at vertical intervals of 25 feet maximum. The waddles on slope faces shall be installed along contours of equal elevation and can be secured with wood stakes, as needed. The desiltation basins have been sized based on SCVURPPP’s volume-based treatment control requirements from their *C.3. Stormwater Handbook* as well as the criteria in the State Water Resources Control Board’s (SWRCB) *Water Quality Order 99-08-DWQ*. The sizing calculations are contained in Chang Consultants’ April 14, 2009, *Drainage Report for Permanente Quarry East Materials Storage Area*. The

report also contains engineering analyses for the outlet works and emergency spillway at each desiltation basin.

The majority of the EMSA runoff will be conveyed to one of the perimeter desiltation basins by a series of ditches and downdrains. These drainage facilities have been sized to convey the tributary 100-year flow. The hydrologic and hydraulic analyses used to design the facilities are contained in Chang Consultants' *Drainage Report*. Portions of the ditches within the perimeter road and the downdrains will have a steep gradient. As a result, these will be lined with riprap or other erosion-resistant material to prevent erosion.

Inspections and maintenance of the temporary erosion control measures will be performed, as needed. Silt fencing and straw wattles can either be repaired or replaced depending on their condition. Sediment and debris that accumulates in the desiltation basins and their outlet works will be removed. Similarly, sediment and debris will be removed from the ditches and downdrains and these drainage facilities will be inspected for erosion. The inspections and maintenance will ensure that the temporary measures provide adequate erosion control for the EMSA until the permanent measures are established.

PERMANENT EROSION CONTROL MEASURES

The permanent erosion control measures will include the drainage ditches and downdrains described in the previous section as well as revegetation. The temporary desiltation basins and silt fencing will be removed as revegetation allows. The "Erosion Control Measures Following Final Revegetation Exhibit" in the map pocket of this report illustrates the permanent erosion control measures including the permanent revegetation plan.

The objective of the revegetation plan is to provide native vegetative cover for final contours, thus controlling erosion and stabilizing slopes, using plant materials capable of self-regeneration without continued dependence on irrigation, soil amendments, or fertilizer in accordance with the reclamation standards. Revegetation will be sufficient to stabilize the surface against the effects of long-term erosion and is designed to meet the post-extractive land use objectives of the site. Hydroseeding of the finished slopes with a mixture of native grasses, herbaceous plants, and shrubs will provide surface cover and erosion control for the new slopes. Tree and shrub planting areas will be located on benches of the revegetation areas to encourage the long-term development of an oak savannah on north-facing slopes, or native scrub community on south-facing slopes. These communities will provide visual integration of the EMSA with the surrounding hillsides. The following sections outline the revegetation. The revegetation pursuant to the Reclamation Plan will include a test plot program, soil treatment and plant installation, maintenance and adaptive management guidelines, and verifiable monitoring standards to assure success of revegetation.

Hydroseeding

Contoured surfaces will be covered with native grass, herbaceous, and shrub species via hydroseeding homogenous slurry of mulch, fertilizer, seed, and a binding agent over the areas to be revegetated. Drainage ditches and access roads will be left bare until the completion of the stockpiling at which time the roads will be revegetated. Local seed suppliers have been working with Lehigh staff to develop an appropriate native seed mix for reclamation, and are testing several mixes in the test plots. Adaptive

management will continue to be used in the future to determine what seed mixes and slurry amendments are most effective for achieving revegetation goals. A preliminary hydroseed mix of shrubs and grasses is shown in Table 2, which includes species known to thrive in undisturbed quarry areas or known to perform well in previous revegetation areas. These species should be used, pending availability, for the earliest stages of the proposed reclamation project, until test plot results can be used to further refine and expand the species selection.

Trees and Shrubs

The interslope benches will have deeper soils and will be planted with tree and shrub species. The north and east facing benches will support the greatest diversity of trees and shrubs since they have less solar radiation and less intense temperatures. South-facing benches will generally be planted with shrubs, however, grey pine (*Pinus sabiniana*), a native tree species that is tolerant of very dry conditions, will also be used in these areas.

Table 2. Preliminary species for general slope hydroseeding.		
SCIENTIFIC NAME	COMMON NAME	Suitable aspect (different mixes may be utilized on north-facing [N] vs. south-facing [S] areas)
SHRUBS		
<i>Adenostoma fasciculatum</i>	chamise	S
<i>Artemisia californica</i>	California sagebrush	N and S
<i>Baccharis pilularis</i>	coyote brush	N and S
<i>Ceanothus cuneatus</i>	buckbrush	N and S
<i>Eriogonum fasciculatum</i>	California buckwheat	S
<i>Heteromeles arbutifolia</i>	toyon	N
<i>Mimulus aurantiacus</i>	sticky monkeyflower	N
<i>Salvia leucophylla</i>	purple sage	S
<i>Salvia mellifera</i>	black sage	S
GRASSES AND HERBS		
<i>Elymus glaucus</i>	blue wildrye	N and S
<i>Eschscholzia californica</i>	California poppy	N and S
<i>Heterotheca grandiflora</i>	telegraph weed	N and S
<i>Lotus scoparius</i>	deerweed	N and S
<i>Lupinus nanus</i>	sky lupine (innoc.)	N and S
<i>Nassella pulchra</i>	purple needlegrass	N and S
<i>Plantago erecta</i>	California plantain	N and S
<i>Vulpia microstachys</i>	three weeks fescue	N and S

Trees and shrubs will be planted as container plants or acorns in the revegetation areas to encourage re-establishment of a vegetative community similar in structure to that of the surrounding areas. Plantings will occur on the benches where a deeper layer of soil treatment materials is applied to ensure adequate space for root development. These deeper soils with container plantings will be prepared on contoured benches, while slopes will be covered with shallower soils and hydroseeded. To the extent practicable,

trees and shrubs to be planted will be obtained from seeds collected on-site or from local sources. At least 10% of the total restoration area will be planted in tree and/or shrub planting areas. Shrubs will be planted at approximately 4.5-foot spacing (680 shrubs per acre) and trees at 9-foot spacing (up to 170 trees per acre) in the designated areas.

As with hydroseeding, adaptive management will be used to determine which tree and shrub species will be planted, the most effective spacing and location, and species to use in replacement plantings if necessary. A preliminary list of trees and shrubs to be planted on benches of the RPA Area is provided in Table 3. Species selection and numbers will depend on propagule collection and availability, as well as on test plot results.

Table 3. Preliminary list of trees and shrubs for planting on RPA Area benches.		
SCIENTIFIC NAME	COMMON NAME	Potential <i>P. ramorum</i> host?
TREES (may use acorns instead of container planting for some oaks)		
<i>Arbutus menziesii</i>	Pacific madrone	yes
<i>Pinus sabiniana</i>	grey pine	no
<i>Quercus agrifolia</i>	coast live oak	yes
<i>Quercus chrysolepis</i>	canyon live oak	yes
<i>Quercus douglasii</i>	blue oak	no
<i>Quercus lobata</i>	Valley oak	no
<i>Quercus wislizenii</i>	interior live oak	no
SHRUBS*		
<i>Cercocarpus betuloides</i>	mountain mahogany	no
<i>Heteromeles arbutifolia</i>	toyon	yes
<i>Quercus berberidifolia</i>	scrub oak	no
<i>Rhamnus californica</i>	California coffeeberry	yes
<i>Rhamnus crocea</i>	redberry	no
<i>Ribes californicum</i>	hillside gooseberry	no
<i>Ribes malvaceum</i>	chaparral currant	no

* Shrub species selection may change based on the success of seeded shrubs in test plots. Seeding of coyote brush, chamise, California sagebrush, buckbrush, and sticky monkeyflower will be evaluated in test plots in 2009-2010, and if seed germination and establishment success is poor, these species will be tested as container plants. These species are expected to perform well in Quarry revegetation areas once an effective establishment method is identified.

Timing

All hydroseeding should be performed and completed between October 1 and December 1 to take advantage of warm soil temperatures and winter rains for successful germination and establishment. Container planting should be performed during the winter season and completed by approximately the end of January to improve successful establishment.

CONCLUSION

This erosion control plan has been developed for the East Materials Storage Area proposed at the Permanente Quarry. The EMSA will be used to store overburden material and will ultimately be planted with native materials. There are no impervious areas proposed at the EMSA. As a result, the proposed reclamation will have a low runoff potential. Temporary best management practices will be used at the site until the revegetation is established. The temporary erosion control measures include desiltation basins, which have been sized with a greater capacity than required by the SCVURPPP and SWRCB guidelines, hydroseeding, silt fencing, and drainage facilities. The permanent erosion control measures will include the drainage facilities and a detailed revegetation plan in accordance with the Reclamation Plan. This combination of temporary and permanent erosion control best management practices will be used to treat the primary pollutant of concern from the EMSA, which is sediment. The level of treatment has been established to meet or exceed the erosion control criteria of SMARA, SWRCB, and SCVURPPP.

Table 4. Qualitative descriptions of soil surface status	
CLASS 1:	No soil loss or erosion; topsoil layer intact; well-dispersed accumulation of litter from past year's growth plus smaller amounts of older litter.
CLASS 2:	Soil movement slight and difficult to recognize; small deposits of soil in form of fans or cones at end of small gullies or fills, or as accumulations upslope of plant crowns or behind litter; litter not well dispersed or no accumulation from past year's growth.
CLASS 3:	Soil movement or loss more noticeable; topsoil loss evident, with some plants on pedestals or in hummocks; rill marks evident, poorly dispersed litter and bare spots not protected by litter.
CLASS 4:	Soil movement and loss readily recognizable; topsoil remnants with vertical sides and exposed plant roots; roots frequently exposed; litter in relatively small amounts and washed into erosion protected patches.

Prior to the release of financial assurances, disturbed slopes in the EMSA must meet revegetation and erosion control performance standards. These standards have been designed to minimize the potential for stormwater runoff and erosion. Maintenance and monitoring will include identification and repair of erosion damage in order to maintain the standards. Performance criteria and additional slope treatment for erosion control are based on the qualitative descriptions and remedial measures described in Tables 4 and 5, respectively. The need for remedial measures will be determined by field observations. In general, areas receiving an average score of Class 3 or 4 will receive additional slope treatment. Any observable reason for failure will be noted and the appropriate remedial measure stated as part of the annual monitoring report.

Table 5. Remedial measures for erosion control	
CLASS 1:	No action necessary.
CLASS 2:	Monitor to see if any further deterioration and action is required.
CLASS 3:	Any rills or gullies in excess of 8 square inches in cross-sectional area and more than 10 linear feet located on finished slopes shall be arrested using straw mulch or equivalent.
CLASS 4:	Replant and cover with straw mulch and install silt fences. If necessary, regrade and compact with equipment.

EROSION CONTROL LEGEND

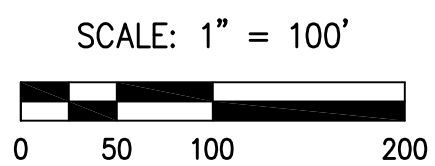
- PERIMETER ROAD DITCH
- BENCH DITCH
- DOWNDRAIN
- SILT FENCE
- SLOPES
- PADS/BENCHES
- DESILTATION BASINS

NOTE: DOWNDRAINS AND PERIMETER ROAD DITCHES SHALL BE LINED TO PREVENT EROSION

EROSION CONTROL SEED MIX

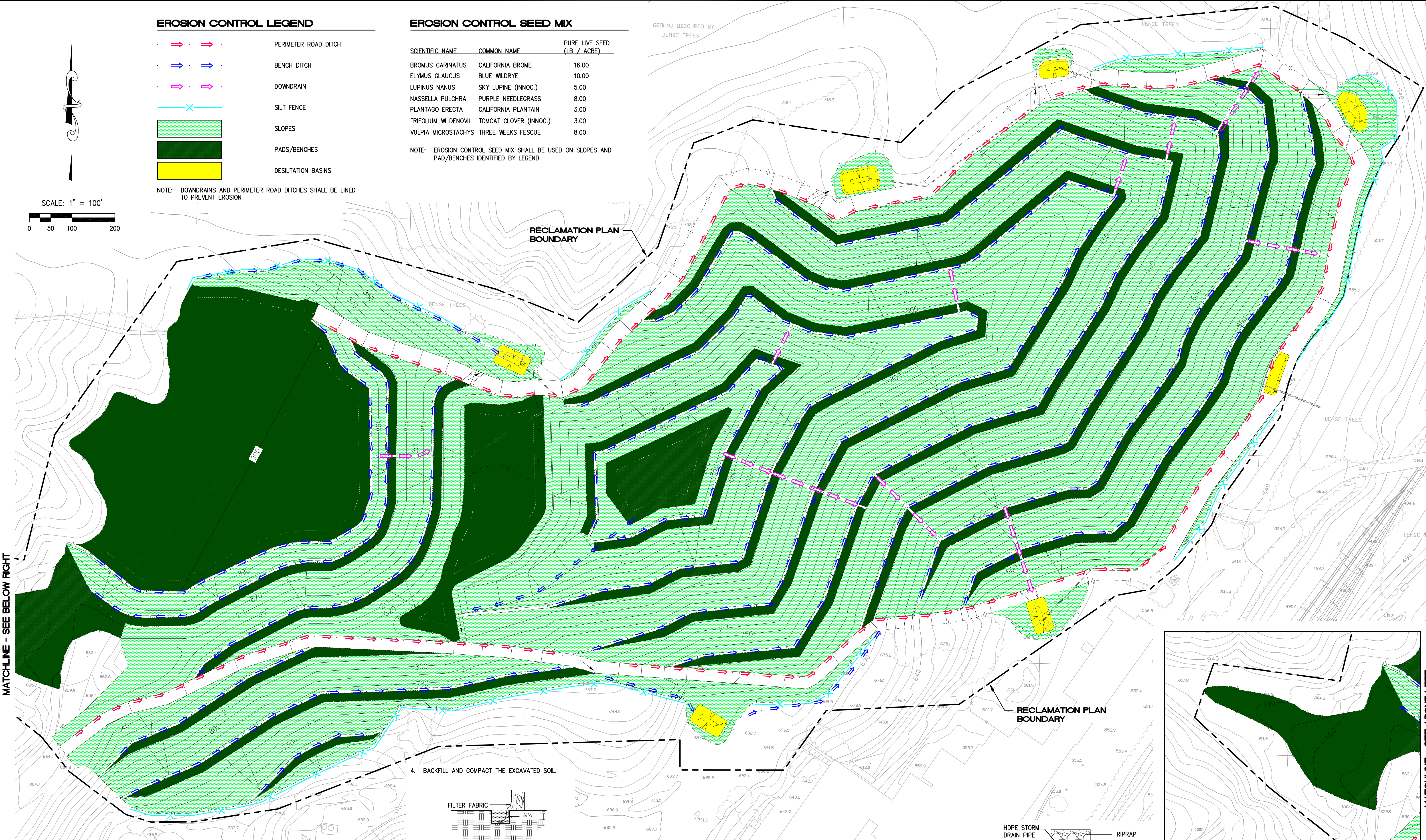
SCIENTIFIC NAME	COMMON NAME	PURE LIVE SEED (LB / ACRE)
BROMUS CARINATUS	CALIFORNIA BROME	16.00
ELYMUS GLAUCUS	BLUE WILDRIE	10.00
LUPINUS NANUS	SKY LUPINE (INNOC.)	5.00
NASSELLA PULCHRA	PURPLE NEEDLEGRASS	8.00
PLANTAGO ERECTA	CALIFORNIA PLANTAIN	3.00
TRIFOLIUM WILDENOVII	TOMCAT CLOVER (INNOC.)	3.00
VULPIA MICROSTACHYS	THREE WEEKS FESCUE	8.00

NOTE: EROSION CONTROL SEED MIX SHALL BE USED ON SLOPES AND PAD/BENCHES IDENTIFIED BY LEGEND.



MATCHLINE - SEE BELOW RIGHT

MATCHLINE - SEE ABOVE LEFT

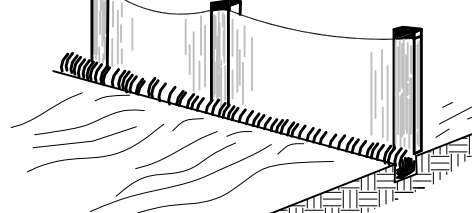
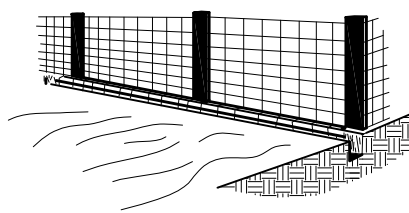
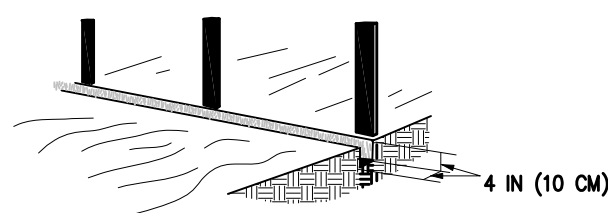


1. SET POSTS AND EXCAVATE A 4 BY 4 IN (10 BY 10 CM) TRENCH UPSLOPE FROM AND ALONG THE LINE OF POSTS.

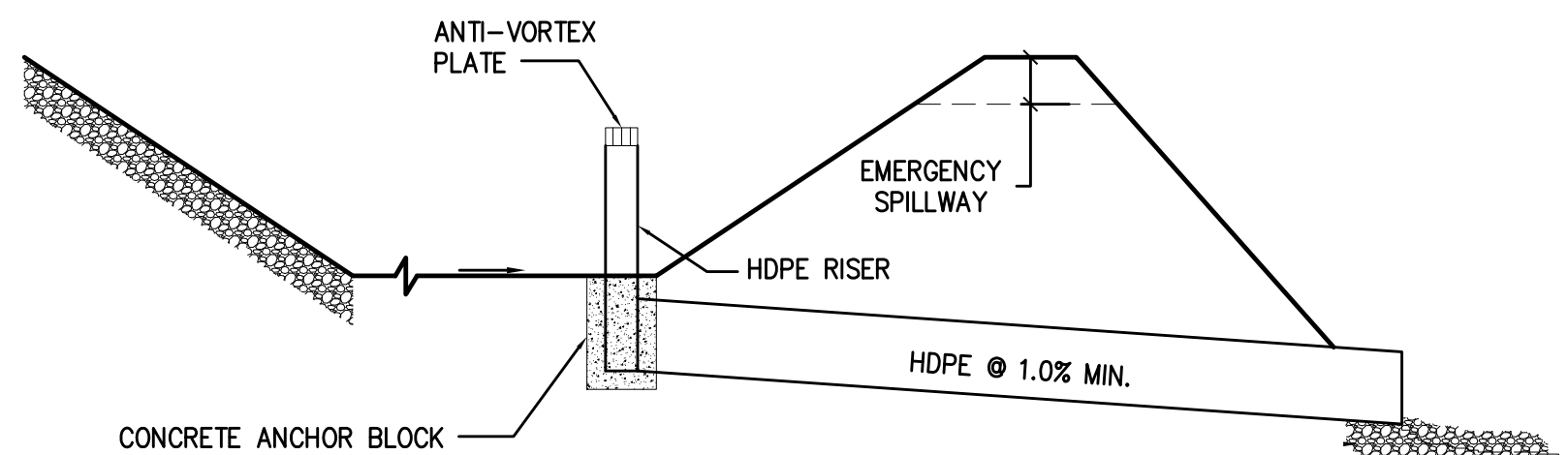
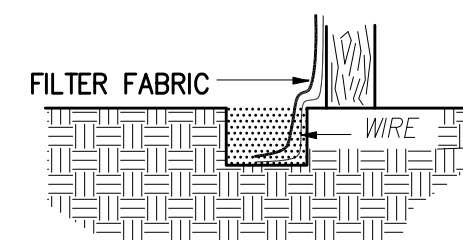
2. STAPLE FABRIC FENCING TO THE POSTS.

3. ATTACH THE FILTER FABRIC TO THE WIRE FENCE AND EXTEND IT INTO THE TRENCH.

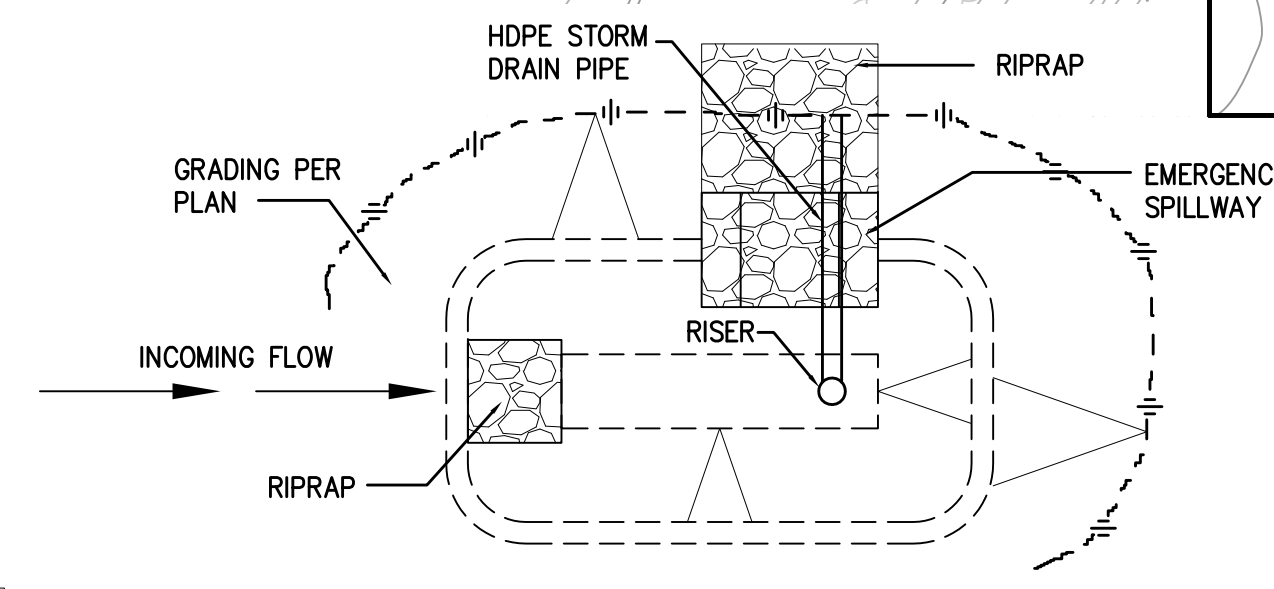
4. BACKFILL AND COMPACT THE EXCAVATED SOIL.



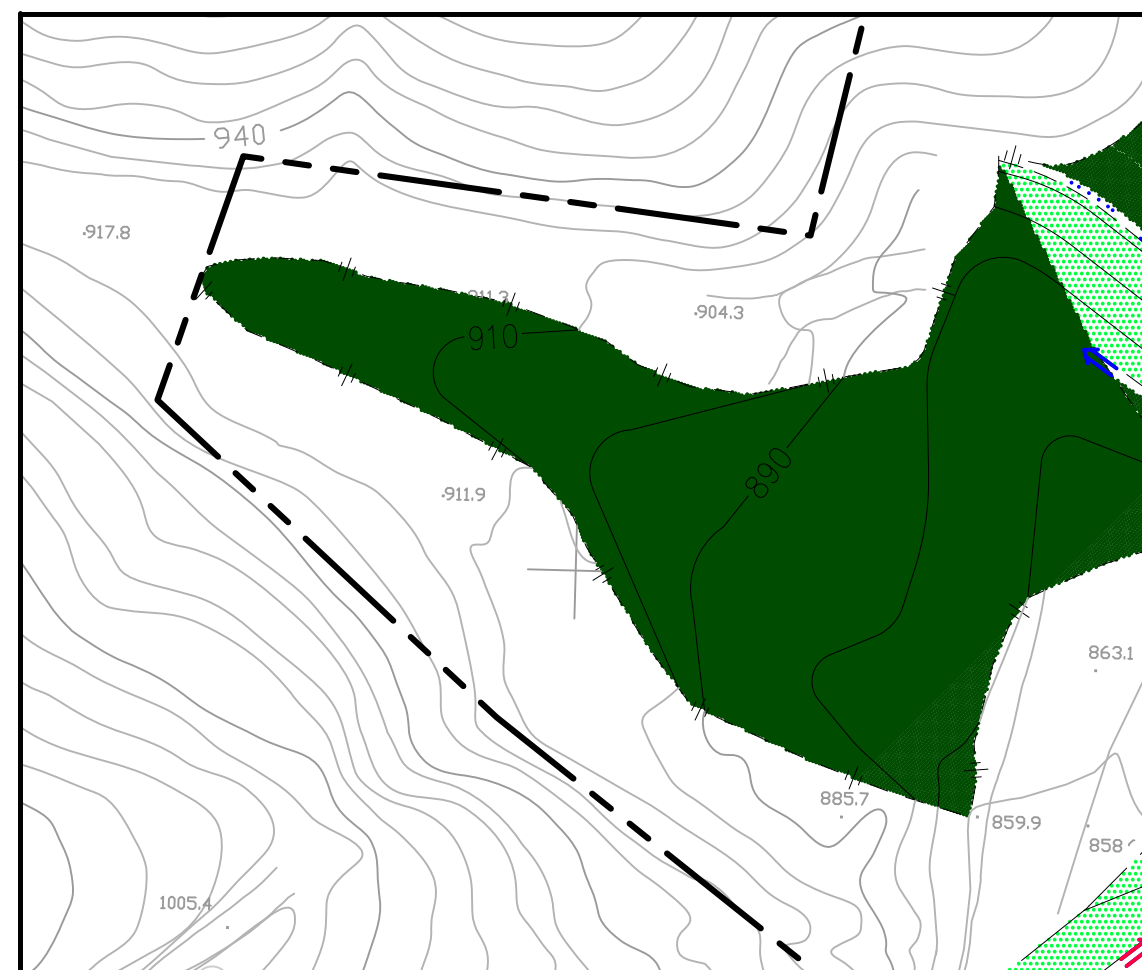
DETAIL: SILT FENCE
NOT TO SCALE



DETAIL: TYPICAL DESILTATION BASIN
NOT TO SCALE








DETAIL: TYPICAL DESILTATION BASIN PLAN VIEW
NOT TO SCALE



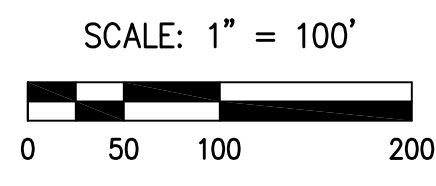
Chang Consultants
Civil Engineering-Hydrology-Hydraulics-Sedimentation
P.O. Box 9498 T: 858.892.0760
Rancho Santa Fe, CA 92067 F: 858.832.1402

**PERMANENTE QUARRY
EAST MATERIALS STORAGE AREA**
EROSION CONTROL MEASURES
1-YEAR FOLLOWING RECLAMATION COMPLETION

EROSION CONTROL LEGEND

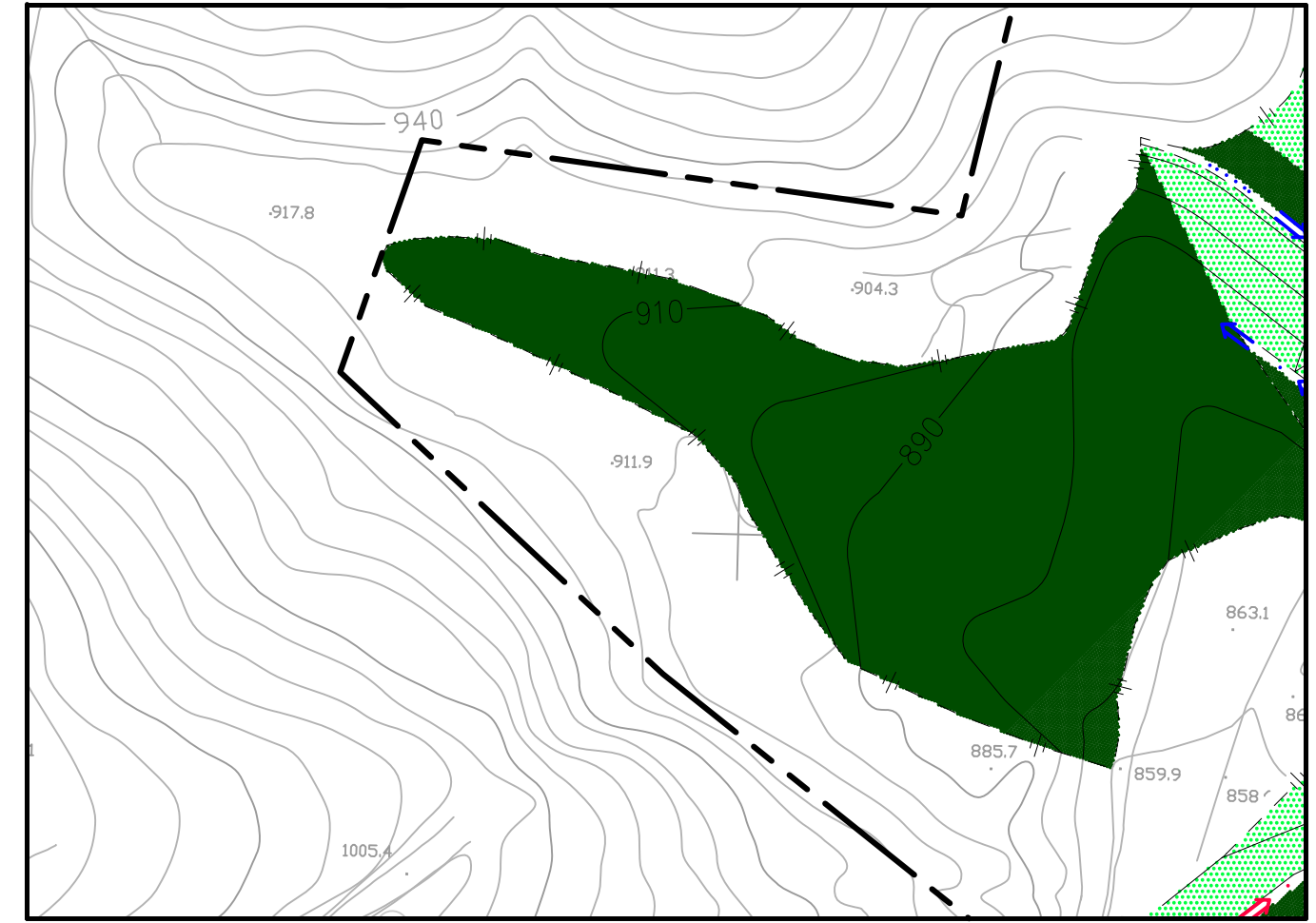
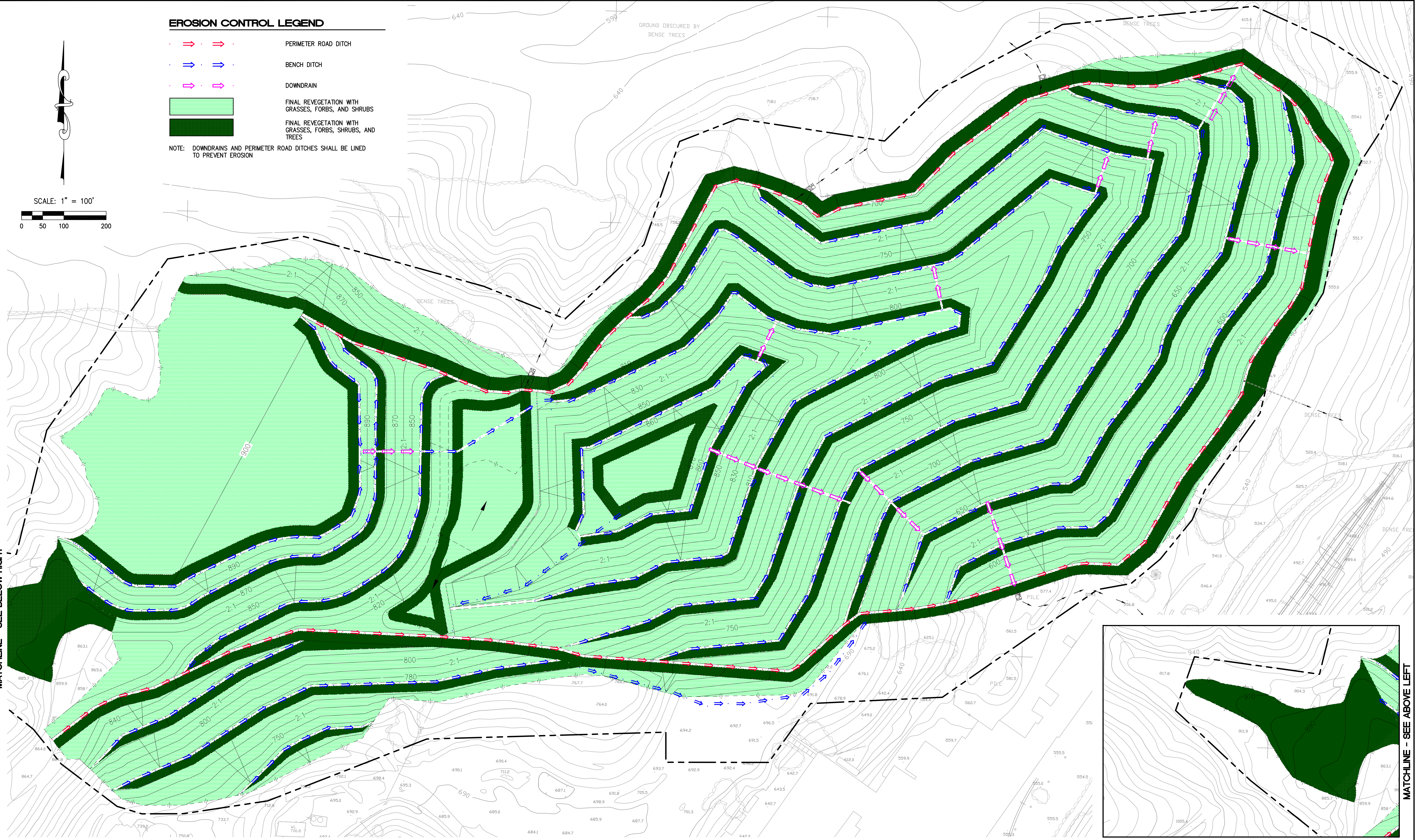
-  PERIMETER ROAD DITCH
-  BENCH DITCH
-  DOWNDRAIN
-  FINAL REVEGETATION WITH GRASSES, FORBS, AND SHRUBS
-  FINAL REVEGETATION WITH GRASSES, FORBS, SHRUBS, AND TREES

NOTE: DOWNDRAINS AND PERIMETER ROAD DITCHES SHALL BE LINED TO PREVENT EROSION



MATCHLINE - SEE BELOW RIGHT

MATCHLINE - SEE ABOVE LEFT



PERMANENTE QUARRY
EAST MATERIALS STORAGE AREA
EROSION CONTROL MEASURES
FOLLOWING FINAL REVEGETATION

ChangConsultants
Civil Engineering-Hydrology-Hydraulics-Sedimentation
P.O. Box 9496 T: 858.892.0760
Rancho Santa Fe, CA 92067 F: 858.832.1402

CHANG CONSULTANTS
858.892.0760

Attachment E
Geotechnical Report

Golder Associates Inc.
425 Lakeside Drive
Sunnyvale, CA USA 94085
Telephone: (408) 220-9223
Fax: (408) 220-9224
www.golder.com



June 4, 2009

Project: 063-7109-400

Lehigh Southwest Cement Company
24001 Stevens Creek Blvd
Cupertino, CA 95014

Attention: Mr. Jeffery Brummert

RE: SUPPLEMENTAL GEOTECHNICAL EVALUATION TO RESPOND TO COMMENT NO. 13, LETTER FROM SANTA CLARA COUNTY DATED MAY 20, 2009, RECLAMATION PLAN AMENDMENT (PERMANENTE QUARRY), FILE 2250-13-66-09P

Dear Mr. Brummert,

We are providing this Supplemental Geotechnical Evaluation in response to Comment No. 13 of Santa Clara County's (County) letter to Mr. Jeff Brummert dated May 20, 2009.

Comment No. 13 provided a critique of certain aspects of Golder Associates Inc.'s (Golder) *Slope Stability Evaluation for Compliance with SMARA, East Materials Storage Area, Permanente Quarry, Cupertino, California*, dated April 2009. The comment requested a supplemental evaluation to address the potential effects of previously-mapped faults and historical landslides upon slope stability in the East Materials Storage Area (EMSA) during seismic events. The comment also questioned the appropriateness of the seismic coefficient referenced in Golder's report. This Supplemental Geotechnical Evaluation responds to these comments by providing clarifications to our April 2009 report. It is our opinion that the issues raised in Comment No. 13 were thoroughly addressed in our report; however, we are pleased to offer this letter to provide further detail regarding the issues raised by the County.

Comment No. 13 is reproduced below.

13. Golder Associates report titled "Slope Stability Evaluation for Compliance with SMARA, East Materials Storage Area ..." (dated 4-1-2009) presents the results of numerous slope stability calculations for three cross-sections using a seismic coefficient of 0.15. That coefficient is too low considering a 0.6g peak ground acceleration. Sorg and McLaughlin (1975) mapped a fault trace and several landslides in the eastern portion of the site; however, the report does not evaluate these. Therefore, submit four (4) copies of a supplemental evaluation report on the potential effects (weak rock, groundwater barrier, etc.) the faults and landslides might have on slope stability under strong shaking and how to mitigate them.

From our understanding, the comment raises two specific issues:

1. A technical opinion that the seismic coefficient of 0.15 used by Golder is too low for a peak ground acceleration of 0.6g, and,

2. A technical opinion that landslides and a fault trace shown on a regional geologic map reference (Sorg and McLaughlin, 1975) have not been evaluated with respect to their potential influence on slope stability and no mitigation has been provided.

A detailed response for each issue is provided in the following sections.

Appropriate Seismic Coefficient

The County's comment No. 13 states that Golder presented numerous calculations based on a seismic coefficient of 0.15g, which is too low for a design peak ground acceleration of 0.6g. As a clarification to this statement, our slope stability analyses involved the following steps:

1. A simplistic pseudo-static approach was first used where a seismic coefficient of 0.15g was assumed based on criteria proposed by Seed (1979)¹. This criteria states that if the computed pseudo-static factor of safety is greater than 1.15, then the anticipated permanent seismically-induced displacements are expected to be well within "acceptable limits," which Seed considered to be approximately one meter (approximately 3 feet) for large embankments and dams. In addition, a seismic coefficient of 0.15g is assumed for large earthquakes with magnitudes of up to M8.25. If the pseudo-static factor of safety is less than 1.15, a more sophisticated displacement type approach is required and the second step below is completed.
2. For pseudo-static factors of safety less than 1.15, a displacement approach by Bray and Travararou² (2007) was used to estimate the magnitude of permanent, seismically-induced displacements. This second step is a more refined evaluation of the seismic performance of slopes than the first step and does not use a seismic coefficient as part of the evaluation.

Cross-section E3 is the critical cross-section evaluated for the EMSA (i.e., section with the lowest factor of safety). This cross-section has a computed pseudo-static factor of safety of 1.12, which is less than the minimum pseudo-static factor of safety of 1.15 recommended by Seed (1979). Therefore, the second step discussed above was implemented, and permanent seismically-induced displacements of between 2 and 8 inches were estimated for slopes comprised of the coarse rockfill. If a larger seismic coefficient were assumed by Golder as part of the first step, the second step would be still triggered and the computed displacements would remain the same. Therefore, assuming a larger seismic coefficient value does not affect Golder's slope stability results and conclusions for the EMSA.

Although the assumed seismic coefficient value of 0.15g does not impact the Golder's results or conclusions, we are providing the following explanation as to why the criteria established by Seed (1979) is appropriate for this project. The discussion below is supported by Special Publication 117 – "Guidelines for Evaluating and Mitigating Seismic Hazards in California" prepared by the California Geological Survey (last updated in 2008).

¹ Seed, H. B. (1979), "Considerations in the Earthquake-Resistant Design of Earth and Rockfill Dams," *Geotechnique*, vol. 29, No. 3, pp. 215-263.

² Bray, J. D., and Travararou, T. (2007), "Simplified Procedure for Estimating Earthquake-Induced Deviatoric Slope Displacements", *Journal of the Geotechnical and Geoenvironmental Engineering, ASCE*, Vol. 133, No. 4, pp. 381-392.

A pseudo-static analysis is a very simplistic method for evaluating the complex seismic performance of a slope. This approach is valid and generally conservative only if properly applied and the limitations of the method are clearly understood. A little more than a half dozen pseudo-static criteria have been proposed by various researchers such as Seed (1979). Hynes and Franklin (1984)³ and Blake et al.⁴ (2002) are examples of other criteria proposed for performing pseudo-static analyses. These criteria generally involve the selection of a seismic coefficient based on the size of the earthquake (and sometimes other factors) and specifying a minimum “threshold” pseudo-static factor of safety. If the calculated pseudo-static factor of safety is greater than the specified threshold value, then the permanent seismically-induced displacements are considered to be within the magnitude of allowable displacements contemplated by the particular criteria being followed. If the pseudo-static factor of safety is less than the threshold value, then the pseudo-static approach is no longer applicable and the designer can either (1) redesign the slope to increase the pseudo-static factor of safety to exceed the threshold value, or (2) use more sophisticated evaluation techniques such as the displacement method used by Golder in the second step described previously.

One of the key elements in selecting the appropriate pseudo-static criteria for a given project is to first establish the allowable permanent displacements that can be tolerated by the project. Since the EMSA will be reclaimed as undeveloped open space, the allowable displacements are up to 2 to 3 feet. For the EMSA, Golder selected the criteria proposed by Seed (1979), which contemplated allowable displacements of up to one meter (approximately 3 feet). If the EMSA proposed the development of buildings or other sensitive structures at the top of the slope, along the slope, or immediately at the toe of the slope, then Seed’s (1979) criteria would not be appropriate because displacements of 2 to 3 feet could result in adverse distress on these structures. In fact, the County’s assertion that a seismic coefficient of 0.15 is too low for the EMSA would be reasonable if the EMSA involved a post-reclamation development instead of the proposed undeveloped open space.

Confirmation of the appropriateness of the Seed (1979) criteria is provided by examining the stability results for Cross-section E3. The computed pseudo-static factor of safety of 1.12 triggers a more detailed evaluation of the seismic performance of the slope because it is less than the minimum threshold value of 1.15. The computed permanent displacements are less than one foot and well within the 2- to 3-foot allowable displacement for the EMSA. Cross-sections with higher pseudo-static factors of safety would have even lower permanent displacements. Therefore, the Seed (1979) criteria provide a conservative trigger of more detailed slope evaluations for the EMSA.

To further support the above conclusion, Golder considered the pseudo-static criteria established by Blake et. al (2002). This approach ties the selection of a seismic coefficient to the allowable permanent displacement (and other factors), and was specifically developed for projects that involve critical structures that can only tolerate relatively small displacements. Blake et. al (2002) developed charts for estimating the seismic coefficient for allowable displacements of 2 inches and 6 inches. However, this methodology can be expanded to consider larger allowable displacements.

³ Hynes, M.E., and Franklin, A.G., 1984, Rationalizing the Seismic Coefficient Method, U.S. Army Corps of Engineers, Waterways Experiment Station, Vicksburg, Mississippi, Miscellaneous Paper GL-84-13, July 1984.

⁴ Blake, T.F. Hollingsworth, R.A., and Stewart, J.P. 2002, Recommended Procedures for Implementing DMG Special Publication 117 – Guidelines for Analyzing and Evaluating Seismic Hazards in California: Committee organized through ASCE, Los Angeles Section Geotechnical Group, Published by the Southern California Earthquake Center, 101p.

For the EMSA, Golder calculated the following seismic coefficients (k) using the approach of Blake et.al (2002) for varying allowable displacements:

- Allowable displacement of 6 inches: k = 0.29
- Allowable displacement of 2 feet: k = 0.20
- Allowable displacement of 3 feet: k = 0.17

As indicated from the above calculations, the seismic coefficient decreases as the allowable displacements increase. For the EMSA, with allowable displacements of 2 to 3 feet, this latter approach yields calculated seismic coefficients of between 0.17 and 0.20. Although these values are slightly larger than that assumed by Golder, the minimum threshold pseudo-static factor of safety for this approach is 1.0 instead of the 1.15 value proposed by Seed (1979). The net effect of using slightly higher seismic coefficients with a lower threshold pseudo-static factor of safety is that the pseudo-static conclusions based on Seed's (1979) criteria yield almost identical conclusions to that based on the approach by Blake et. al. (2002) when considering allowable displacements of several feet. This further confirms that a seismic coefficient of 0.15 is appropriate for the EMSA using the criteria established by Seed (1979).

Influence of Possible Faulting and Landslides on Slope Stability

Golder performed a detailed engineering geologic and geotechnical investigation of the proposed East Materials Storage Area (EMSA) including analyses of aerial photographs, geologic field mapping and subsurface drilling, sampling and analyses. One of the specific objectives of this work was to evaluate the foundation conditions in the area of the proposed rockfill, and specifically any geologic conditions that might be detrimental to the stability of the fill. The conditions that were evaluated included, but were not necessarily limited to, the presence of:

- potential landslides,
- thick potentially unstable or compressible surficial deposits (i.e., soil and colluvium),
- fault traces or fault zones,
- unsuitable soft or weak bedrock, and,
- groundwater seeps or springs.

The work performed was conducted in accordance with industry standards for geologic and geotechnical investigations. As part of this work, and in accordance with standard practice, existing geologic map references for the area were compiled and reviewed as a starting point for the field investigation. The following geologic references were reviewed and referenced in our report:

Brabb, E. E., R.W. Graymer, and D.L. Jones "Geologic Map and Map Database of the Palo Alto 30' x 60' Quadrangle, California" Miscellaneous Field Studies Map MF-2332 (2000).

Foruria, J., 2004. Geology of the Permanente Limestone and Aggregate Quarry, Santa Clara County, California. Report prepared for Hanson Permanente Cement dated September 24, 2004.

Mathieson, E.L., 1982. Geology of the Permanente Property, Kaiser Corporation, Permanente, California, unpublished Kaiser Permanente Cement Company report, 34 p.

Rogers, T.H. and Armstrong, C.F., 1973, Environmental Geologic Analysis of the Monte Bello Ridge Mountain Study Area, Santa Clara County, California, California Division of Mines and Geology Preliminary Report 17.

Sorg, D.H., and McLaughlin, R.J., 1975. Geologic Map of the Sargent-Berrocal Fault Zone Between Los Gatos and Los Altos Hills, Santa Clara County, California: U.S. Geological Survey Miscellaneous Field Studies Map MF-643, scale 1:24,000

Vanderhurst, W., 1981, The Santa Clara Formation and Orogenesis of Monte Bello Ridge, 114 p.

In conjunction with review of the maps above, we prepared a compilation map for use in the field and for mapping from aerial photographs. Based on our own interpretation of the site geology, and the detailed nature of the Rogers and Armstrong map (i.e., 1:12000 scale mapping versus 1:24000 scale for Sorg and McLaughlin), we selected the Rogers and Armstrong interpretation of the bedrock geology in the area of the EMSA as the starting point for our investigation. We then performed mapping of surficial deposits, and the grading history of the site, using a series of aerial photographs extending back to 1939. Following that work we performed several reconnaissance mapping trips of the site, and implemented the drilling program. The final interpretation of the geologic conditions of the site is illustrated on the following figures included in our report and discussed in the text:

Figure 3 – Regional Geotectonic Setting

Figure 4 – Geologic Map, East Materials Storage Area

Figure 5 – Surface Mapping, East Materials Storage Area

Figure 6 – Cross-Sections, East Materials Storage Area

With respect to the map by Sorg and McLaughlin (attached), we differ with their interpretation of site conditions on the following points:

- We reviewed the mapped landslides both on aerial photographs and in the field. We did not see evidence of active or older, dormant landslides (e.g., scarps, unit surfaces, hummocky or disturbed ground), rather the referenced areas they identified as landslides, we mapped as naturally-occurring drainage swales that are filled with relatively thick accumulations of colluvium. Note that Rogers and Armstrong did not map landslides in the area of the EMSA on their detailed Surficial Deposits map (Plate 2 of their report). The colluvial areas are depicted on Figure 5, and discussed in Section 3.2.1 of the report. Mitigation for the colluvial-filled swales is discussed in Section 4.5.2 and Section 5.2.
- With regard to the fault depicted crossing the eastern margin of the property, our interpretation of the bedrock geology in this area generally conforms to that of Rogers and Armstrong. On Figure 4 of our report, this contact is shown as a depositional contact of Plio-Pleistocene Santa Clara Formation unconformably overlying the Franciscan Complex. At the EMSA we believe an erosional “window” through the Santa Clara formation has exposed the underlying Franciscan formation in the area of the EMSA. Sorg and McLaughlin interpret this contact as a fault along the eastern margin of the EMSA but elsewhere map the same contact as a depositional contact.

- Further to the east (about 300 feet), we show a fault contact between Monterey Formation and the Santa Clara Formation. This is consistent with Sorg and McLaughlin south of Permanente creek; however, for some reason they do not carry this relationship north of Permanente creek. Our interpretation is that this fault contact persists both north and south of Permanente Creek, and again this is consistent with Rogers and Armstrong.

Regardless of the nature of the contact (i.e., fault versus unconformity), we have thoroughly investigated the engineering properties of both the surficial materials and the bedrock materials at the site. Furthermore, we have chosen relatively conservative strength parameters and groundwater conditions for use in the slope stability evaluations of the site. As discussed in the report, the following characteristics were used for the native materials at the EMSA:

- **Foundation Soils:** According to the subsurface investigation summarized in Section 3, the foundation soils beneath the proposed EMSA are generally characterized as sandy clay to clayey sand with gravel to a silty or clayey gravel with sand". Based on in-situ strength characterization performed using Standard Penetration Testing (SPT), an internal friction angle of 28 degrees with no cohesion was conservatively used to represent the mean drained strength of the Foundation Soil under the EMSA for long-term stability modeling. An average thickness of 10 ft and a moist unit weight of 120 pcf were assumed.
- **Bedrock:** As discussed in Section 3.1.3, a shear strength characterized with a cohesion of 10 psi or 1,440 psf and a friction angle of 23 degrees was used in stability models to represent the Greenstone in Section E1 in accordance with Golder (2008) and the Greywacke in Section E3.
- **Groundwater:** Available historical data indicate groundwater depths ranging from approximately 40 feet to over 200 feet below ground surface. No groundwater was encountered in any of the Golder borings drilled at the EMSA in 2007. No seeps or springs were observed during the investigation. For the purposes of the slope stability analyses, Golder conservatively assumed that permanent groundwater is approximately 30 ft to 100 ft below existing ground surface with water levels more shallow at the toe of the proposed waste fill slope. The estimated groundwater depths do not adversely affect the stability of the EMSA slopes.

Lastly, we have provided specific recommendations for mitigation of potential localized areas of poor foundation conditions; including weak rocks, locally saturated areas or thick soils. These are summarized in Section 4.5.2 of our report and included herein:

4.5.2 Subgrade Preparation

The placement of the EMSA materials on organic rich topsoil, soft or clayey colluvium, or over saturated soils could result in foundation soil conditions with lower effective shear strengths than assumed in this study. A series of slope stability analyses were completed to determine the extent of foundation improvements that should be completed for the EMSA construction.

Based on the results of these analyses, Golder concludes that foundation preparation should be completed on the outer 50 feet of the EMSA fill. The foundation preparation should include over-excavation of the upper topsoil, organic debris, and fine grained colluvium with

high plasticity index to expose firm bedrock, granular soils or lean clay. In areas where the outer 50 feet of the footprint is founded on a native slope that is steeper than 5H:1V, the topsoil and colluvium over-excavation should be extended to 100 feet from the outer slope.

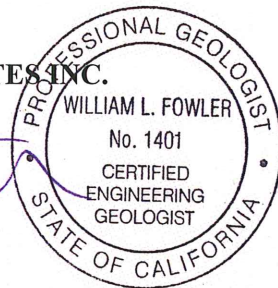
Closing

In summary, we believe both issues raised in Item #13 of the County letter were adequately addressed in our original report. The report was not incomplete, as both issues were specifically covered by the scope of the report. We do, however, recognize that some clarification regarding these issues may be warranted and we trust that this letter will provide adequate information to resolve the issues.

Please feel free to contact myself or Ken Haskell if you have any questions.

Sincerely,

GOLDER ASSOCIATES INC.



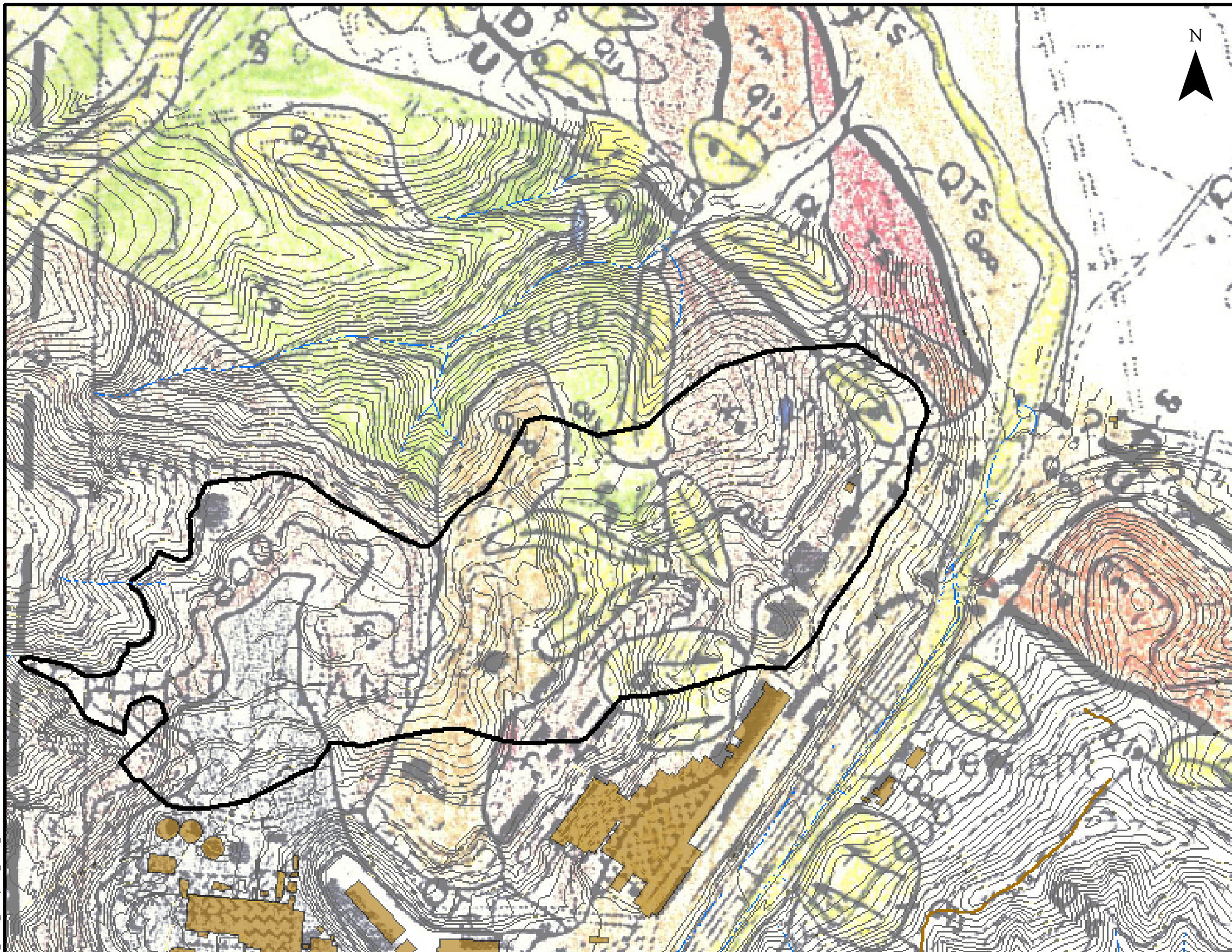
William L. Fowler, P.G., C.E.G.
Associate/Program Manager



Ken Haskell, P.E.
Principal/Senior Practice Leader

Attachment

Figure 1– Geologic Map of the EMSA (Sorg and McLaughlin, 1975)



LEGEND

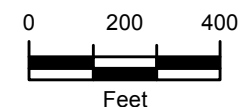
- Stream (ephemeral)
- Topographic contour (feet, MSL)
- Building/structure
- Proposed EMSA Boundary
- Geologic Unit:*
- Fill (Qf)
- Alluvium (Qal)
- Landslide (Qls)
- Older Alluvium (Qoa)
- Santa Clara Formation (QTs)
- Unnamed Sandstone and Shale (Tss)
- Monterey Shale (Tm)
- Franciscan Assemblage: metashale and metagraywacke (fs)
- Franciscan Assemblage: greenstone (fg)
- Franciscan Assemblage: Calera Limestone member (fl)

NOTES

REFERENCES

Site topography (April 2009); USGS geology from Misc. Field Studies Map 642, Figure 1, The Sargent-Berrocal and San Andreas Fault zones between San Juan Bautista and Los Altos Hills, CA (Sorg and McLaughlin, 1975).

Map Document: G:\Hanson_USGS_GEOI_26\May2009_11x17_bf.mxd



SCALE	AS SHOWN
DATE	5/28/2009
DESIGN	DLM
GIS	DLM
CHECK	WLF
REVIEW	WLF

FILE No.	
PROJECT No.	063-7109
REV.	0

**LEHIGH SOUTHWEST CEMENT COMPANY
PERMANENTE QUARRY
CUPERTINO, CALIFORNIA**

GEOLOGY MAP (Sorg and McLaughlin) FIGURE 1



**SLOPE STABILITY EVALUATION
FOR COMPLIANCE WITH SMARA
EAST MATERIALS STORAGE AREA
PERMANENTE QUARRY
Santa Clara County, California**

Prepared for:

*Lehigh Southwest Cement Company
Cupertino, California*

Prepared by:

*Golder Associates
425 Lakeside Drive
Sunnyvale, CA 94085*

Distribution:

- (3) Copies – Lehigh Southwest Cement Company
- (3) Copies – Golder Associates Inc

April 2009

063-7109-400



**SLOPE STABILITY EVALUATION
FOR COMPLIANCE WITH SMARA
EAST MATERIALS STORAGE AREA
PERMANENTE QUARRY**

SANTA CLARA COUNTY, CALIFORNIA

Prepared for:

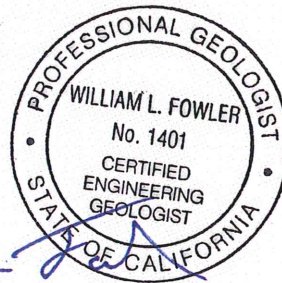
*Lehigh Southwest Cement Company
Cupertino, California*

Prepared by:

*Golder Associates
425 Lakeside Drive
Sunnyvale, CA 94085*



Kenneth G. Haskell, P.E.
Principal/Practice Leader



William L. Fowler, P.G., C.E.G.
Associate/Senior Consultant

Peter Yuan, P.E.
Senior Project Engineer

April 2009

063-7109.400

TABLE OF CONTENTS

<u>Section</u>	<u>Page</u>
1.0 INTRODUCTION	1
2.0 GEOLOGIC SETTING	2
2.1 Site Geology	2
2.2 Regional Structure	2
2.3 Seismic Hazards	3
3.0 SITE GEOTECHNICAL INVESTIGATIONS	4
3.1 Previous Site Investigations	4
3.1.1 Call and Nicolas	4
3.1.2 The MINES Group, Inc.	4
3.1.3 Golder Associates - WMSA Stability Review.....	5
3.2 Golder Investigations.....	6
3.2.1 Surface Mapping/Aerial Photography Review	6
3.2.2 Subsurface Drilling.....	6
3.2.3 Earth Materials	7
3.2.4 Geotechnical Laboratory Testing	7
4.0 SLOPE STABILITY EVALUATIONS	8
4.1 Regulatory Issues.....	8
4.2 Approach and Assumptions.....	8
4.2.1 Methodology	8
4.2.2 Modeling Inputs and Assumptions	9
4.3 Static Analyses	10
4.3.1 Static Stability Conditions of EMSA	10
4.4 Seismic Analyses	11
4.5 Additional Analyses	11
4.5.1 Presence of Fine Waste.....	11
4.5.2 Subgrade Preparation.....	12
5.0 CONCLUSIONS AND RECOMMENDATIONS	13
5.1 Conclusions	13
5.2 Recommendations	13
6.0 LIMITATIONS	15
7.0 REFERENCES	16

TABLES

- Table 1 - Material Properties for Stability Analyses
Table 2 - Summary of Dynamic Deformation Analysis

FIGURES

- Figure 1 – Site Location Map
Figure 2 – Site Plan, East Materials Storage Area
Figure 3 – Regional Geotectonic Setting
Figure 4 – Geologic Map, East Materials Storage Area
Figure 5 – Surface Mapping, East Materials Storage Area
Figure 6 – Cross-Sections, East Materials Storage Area

Figure 7 – Subgrade Preparation, East Materials Storage Area

APPENDICES

Appendix A – Geotechnical Boring Logs

Appendix B – Summary of Laboratory Test Results

Appendix C – Slope Stability Evaluation of Proposed Reclamation Plan – East Materials Storage Area

1.0 INTRODUCTION

Golder Associates Inc. (Golder) is submitting this report addressing the results of slope stability analyses completed for the East Materials Storage Area (EMSA) located at the Permanente Quarry near Cupertino, California. The slope stability evaluations were completed to verify that the proposed reclamation of these areas complies with the applicable slope stability-related provisions of the Surface Mining and Reclamation Act (SMARA).

The Permanente Quarry is located at the west end of Stevens Creek Road southwest of Cupertino, CA (Figure 1). The quarry mines limestone primarily for the production of cement and aggregate. The Permanente property is over 3000 acres in size and includes the following main areas (Figure 1):

- The main pit located near the center of the site where mining operations are conducted,
- The West Materials Storage Area (WMSA) located at the west end of the site utilized for permanent storage of waste rock materials,
- The East Materials Storage Area (EMSA) located near the site entrance to the east, and,
- The operations buildings, kilns and associated cement production facilities located near the site entrance and south of the EMSA.

Limestone that is of suitable grade is used for cement production. Unsuitable rock materials (waste rock) excavated from the pit area are placed in permanent stockpiles that are referred to as storage areas. Waste rock materials include low-grade limestone and non-limestone rock materials. The EMSA is a primary storage area for these materials.

The EMSA will be reclaimed in phases, referred to as Phases A, B, and C. Phase C represents the reclamation of the EMSA at the conclusion of Phases A through C. Phase C will bring the west end of the EMSA up to a maximum elevation of 900 feet mean sea level (msl). The maximum overall slope inclination of EMSA will be between 2.5H:1V (horizontal to vertical) to 2.6H:1V at reclamation. The slopes will be comprised of 2H:1V inter-bench slopes which are comprised of 25-foot wide bench spaced at 40-foot vertical intervals. As discussed in Section 4, the final EMSA slopes will be stable under static and seismic loading conditions provided Golder's construction recommendations are implemented as discussed in Section 5.

2.0 GEOLOGIC SETTING

2.1 Site Geology

The following information regarding the geologic setting of the EMSA and immediate surrounding area has been excerpted from Foruria (2004) who has performed detailed geologic mapping of the main quarry.

Cement-grade limestone and aggregate are extracted from the intricately folded and faulted limestones and metabasalts (greenstones) in the quarry. These rocks are part of the Permanente Terrain of the Jurassic-Cretaceous age Franciscan Assemblage. The Franciscan Assemblage represents a subduction zone assemblage of highly deformed, variably metamorphosed, marine sedimentary rocks with oceanic crust-related submarine basalt (greenstone), chert, and limestone. This limestone-metabasalt assemblage reaches a minimum total thickness of approximately 1,100 feet and is moderately inclined to the southeast.

All major stratigraphic horizons within the Franciscan rocks of the quarry are separated by low-angle faults forming a structurally imbricated thrust stack of layered and folded rock units. The Franciscan rocks are tectonically juxtaposed against an overlying section of undated, continentally-derived graywackes, shales, and argillites. The deformed thrust stack is a gently folded, northeast-trending, southeast dipping sequence in the eastern area of the quarry pit and transitions southwestward to a series of en-echelon, northwest-trending, southeast-plunging, anticlinal and synclinal folds in the western area of the pit, and beyond. High angle, brittle faults crosscut the Franciscan rocks, dissecting the rocks along prominent north-south and northwest-southeast orientations. A major through-going regional fault, the northwest strand of the Berrocal fault, crosses through the western end of the quarry. Figure 3 shows the major faults in the site vicinity.

The Santa Clara Formation overlies a portion of the Franciscan Complex rocks in the north-central portion of the EMSA (Figure 4). The Santa Clara Formation is a continental fluvial and alluvial deposit that is composed of unconsolidated to slightly consolidated conglomerate, sandstone, siltstone, and claystone (Vanderhurst, 1981). The age of the Santa Clara Formation ranges from late Tertiary to Pleistocene. Uplift of the Coast Ranges during this time resulted in increased erosion of the mountains and deposition of the Santa Clara Formation. The contact between the Franciscan rocks and Santa Clara Formation is considered to be unconformable, with the Santa Clara Formation deposited on an eroded Franciscan terrain (Rogers and Armstrong, 1973).

Subsequent uplift of the nearby foothills along the Monte Vista fault, which lies along the margin of the valley floor to the east of the site, has resulted in deformation of the Santa Clara Formation. In addition, faulting within the uplifted geologic terrane between the Monte Vista and Berrocal faults has juxtaposed the Santa Clara formation in fault contact with older Franciscan rocks in the western portion of the EMSA (Figure 4). To the east of the unnamed fault, the deformed Santa Clara formation overlies the Franciscan with south-southwest trending dips of up to 50 degrees (Rogers and Armstrong, 1973). A large erosional window east of the unnamed fault in the EMSA exposes greenstone, greywacke and limestone of the Franciscan Assemblage.

2.2 Regional Structure

The San Andreas Fault zone is located approximately 2 miles southwest of the quarry. The Sargent-Berrocal Fault Zone (SBFZ), part of the Santa Cruz Mountains front-range thrust fault system,

parallels the San Andreas to the east and forms the eastern-most structural boundary to the Permanente Terrain.

Near the quarry, the SBFZ consists of two northwest-trending, sub-parallel faults, namely the northeastern-most Monta Vista Fault Zone and the southwestern-most Berrocal Fault Zone (Sorg and McLaughlin, 1975). The Monta Vista Fault Zone is located approximately 1 mile to the northeast of the quarry. A strand of the Berrocal Fault Zone lies beneath the Permanente Cement Plant area to the south of the EMSA, and extends west to other portions of the quarry (Matheson, 1982; Sorg and McLaughlin, 1975).

2.3 Seismic Hazards

The Permanente Quarry is located within the San Francisco Bay Area, which is a region characterized by relatively high seismicity. SMARA does not specify a minimum seismic design event that should be used for slope stability analyses. However, SMARA does specify that the final slopes shall be flatter than the critical gradient, which is defined at the maximum stable slope inclination of a unsupported slope under the most adverse conditions (i.e. seismic loading) that it will likely experience, as determined by current engineering technology. Accordingly, Golder evaluated potential seismic impacts within the EMSA resulting from an earthquake event associated with 10 percent probability of exceedance (POE) in a 50-year period. Golder has used the 10 percent POE in a 50-year event to evaluate seismic impacts for other quarry reclamation projects in California, which has been accepted by the Office of Mine Reclamation, California Department of Conservation.

Using the California Geological Survey (CGS) earthquake data base (Ground Motions for User Selected Site, Probabilistic Seismic Hazards Assessment (<http://www.consrv.ca.gov/cgs/rghm/pshamap/pshamap.asp>), Golder estimates that design peak ground accelerations should be approximately 0.6g for the site.

3.0 SITE GEOTECHNICAL INVESTIGATIONS

3.1 Previous Site Investigations

A number of geotechnical studies have been completed to address slope stability in other areas of the quarry, including the main pit (Call and Nicolas, Inc., or CNI) and the WMSA (The Mines Group, Inc., or MGI; and Golder, 2008), that have relevance to the stability evaluation of the EMSA. These studies are summarized below.

3.1.1 Call and Nicolas

CNI performed a number of geotechnical evaluations of slope stability issues in the main pit in the early 1980's. This work was reviewed for basic geotechnical data for the Franciscan Assemblage rocks and also waste rock materials. The material shear strength data is summarized below:

Franciscan Melange

- Unit weight = 162 pcf
- Cohesion = 2,150 psf
- Internal friction angle = 20.1°

Franciscan Greenstone

- Unit weight = 175 pcf
- Cohesion = 1,000 psf
- Internal friction angle = 31.3°

Waste Fill

- Unit weight = 125 pcf
- Cohesion = 144 psf
- Internal friction angle = 38°

CNI also estimated the mean minus one standard deviation shear strengths in their 2003 report, provided estimates of the shear strength of good quality and poor quality greenstone, and estimate the shear strengths for other geologic materials.

3.1.2 The MINES Group, Inc.

The MINES Group, Inc. (MGI) reviewed the reclamation design for one portion of waste fill located at the northwest corner of the West Materials Storage Area (WMSA) and developed conceptual drainage and sediment control design for the remainder of the waste fill facility in 2001 (MGI, 2001). An evaluation of the slope stability was performed with the following model inputs and design criteria:

- Material Shear Strengths: all materials were modeled with Mohr-Coulomb criteria with the following strength parameters:

- Waste Rock: cohesion (c') = 0 psf; internal friction (ϕ') = 36° ;
- Fine Waste: $c' = 50$ psf; $\phi' = 26^\circ$;
- Colluvial Soil: $c' = 500$ psf; $\phi' = 28^\circ$; and
- Greenstone Bedrock: $c' = 1,882$ psf; $\phi' = 27^\circ$

Development of the above strengths by MGI were based on the physical observed characteristics of the materials and review of past stability studies.

- Groundwater Level: for stability modeling purposes, MGI conservatively assumed the Greenstone Bedrock and most of Colluvial Soil contained groundwater and that the precipitation at the site supported a perched water table above the Colluvial Soil/Greenstone interface that eventually discharged to the surface contributing to the flow in Permanente Creek.
- Stability Criteria: MGI used a minimum design static factor of safety of 1.3 and a minimum pseudo-static (or seismic) factor of safety (FOS) of 1.0 as the stability design criteria. For pseudo-static analyses, a seismic coefficient of 0.15 g was used.

Based upon the stability analyses performed with the above inputs and assumptions, MGI concluded that the design 3H:1V overall slopes of waste rock were expected to be stable under both static and seismic loading. MGI also indicated the presence of fine-grained waste does not appear to control the stability of the waste rock slopes, even when placed within 10 ft horizontal of the final reclaimed slope face.

3.1.3 Golder Associates - WMSA Stability Review

Golder (2008) reviewed the stability of the reclamation design for the WMSA and used the following material strength properties based on review of previous stability evaluations for the main pit and the WMSA and a subsurface investigation by Golder to characterize the foundation conditions at the WMSA:

- Coarse Waste Rock: cohesion (c') = 0 psf; internal friction (ϕ') = 35° ;
- WMSA Foundation Soil: $c' = 200$ psf; $\phi' = 30^\circ$;
- Greenstone Bedrock: $c' = 1,440$ psf; $\phi' = 23^\circ$; and
- Limestone Bedrock: $c' = 12,500$ psf; $\phi' = 30^\circ$

This stability evaluation uses the same strengths summarized above with the exception of the "Foundation Soil", which was characterized based on the subsurface investigation performed for the EMSA discussed in the following section.

3.2 Golder Investigations

Golder completed additional investigations of the EMSA to supplement the existing data for the Permanente Quarry consisting of the following:

- Aerial Photograph review and reconnaissance-level mapping;
- Subsurface drilling; and
- Geotechnical Laboratory Testing.

The following sections provide additional detail on these investigations.

3.2.1 Surface Mapping/Aerial Photography Review

Golder performed a review of aerial photographs and reconnaissance level mapping of the EMSA to define areas of cut and fill, map surficial deposits where present, and to field check the bedrock geology.

A review of aerial photographs dating back to 1939 was performed to identify areas of cut and fill associated with the development of the EMSA and to map surficial deposits. Large areas of the southern and southeastern portion of the EMSA have been excavated to create flat building pads for existing and former structures associated with former industrial operations (Figure 5). Other areas have been previously used for disposal of waste rock materials, and for stockpiling of aggregate products.

The central and northern areas of the site consist of native soils and rock exposed at the surface except for access road construction. In this area several colluvial-filled drainages were mapped (shown where estimated to be greater than approximately five to six feet thick). Southeast of the site, Permanente creek parallels the southeast margin of the site, and is mapped as containing alluvium and artificial fill related to development of the railroads right-of-way and the main access road to the facility.

In general, exposures of bedrock are poor in the EMSA due to surface weathering and soil formation and heavy vegetation in native areas. Occasional, highly weathered outcrops are exposed in the larger cutslope. In general, with minor modifications, the bedrock geology conforms with that previously mapped by regional investigators (Rogers and Armstrong, 1973; Sorg and McLaughlin, 1975; Vanderhurst, 1981).

3.2.2 Subsurface Drilling

Five hollow stem auger borings (EMSA-1 through -5) were drilled in the EMSA with a CME 75 drilling rig (see Figure 4 for borehole locations). The borings were drilled at locations where the proposed waste rock fill will have greater thickness and steeper slopes. The borings were drilled under the supervision of a Golder geologist and logged and sampled using Golder's procedures and methods that follow industry standards (see Appendix A for summary boring logs).

The sampling sequence included the use of a Shelby tube pushed at the beginning of each borehole, if the material was suitable, followed by driven Standard Penetration Test (SPT) samples at approximate five-foot depth intervals. All boreholes were advanced until refusal or a depth of 45 feet. Refusal for the driven sampler (> 50 blows) was common below approximately 15 to 30 feet. Auger refusal was reached at depths starting at about 32 feet below ground surface (bgs).

Groundwater was not encountered during drilling. Borings were backfilled with cuttings to the ground surface. The geotechnical samples were sent to Cooper Testing Laboratory in Mountain View, California for laboratory testing.

3.2.3 Earth Materials

The following section describes the general geologic character of the surficial materials and bedrock units encountered in the field investigations.

3.2.3.1 *Bedrock Materials*

Bedrock materials in the EMSA included greenstone, limestone and graywacke (sandstone) within the sheared Franciscan Assemblage rocks, and poorly consolidated sandstone, gravels and siltstone of the Santa Clara Formation. All of the bedrock materials encountered in the EMSA were weathered to highly weathered and dry. The Franciscan materials were typically angular to sub-angular, and contained hard, consolidated clasts. Colors ranged from dark reddish brown to gray to green. The Santa Clara formation was typically mottled yellowish brown in color and contained sub-rounded to sub-angular gravels comprised of Franciscan Assemblage rocks.

3.2.3.2 *Colluvium*

Colluvial deposits were encountered at the surface in some of the EMSA borings and were also mapped in the larger natural swales in the area. The colluvial materials encountered were predominantly dark yellowish brown clayey sand with gravel to clayey gravel, with some gravelly clay. Gravel size was up to 3-inches. In general, the colluvium was dry and loose to very stiff/dense.

3.2.4 Geotechnical Laboratory Testing

Geotechnical testing consisted of grain-size distribution and Atterberg limits completed by Cooper Testing Laboratories located in Mountain View, California. Attempts were made to obtain intact samples of the clayey portion of the waste fill, and the native foundation soil at the base of the waste fill. However, the samples contained abundant gravel and larger rock fragments that were not suitable for use in laboratory shear strength testing.

The samples obtained of the native foundation soils at the EMSA ranged from a silty sand and gravel to gravelly and sandy clay. Atterberg limits were completed on the finer portion of the waste materials with Plastic Indices ranging from 14 to 26, but generally between 23 and 26.

In all cases, the Plastic Indices were measured on the finer portion of the soil materials that were sampled. These Atterberg limits results are representative of individual soil samples and not necessarily of all of the soil materials sampled.

The geotechnical characterization of the units encountered is discussed in more detail in Section 4.

4.0 SLOPE STABILITY EVALUATIONS

The purpose of this study was to evaluate the geotechnical aspects of the EMSA reclamation for compliance with SMARA and the applicable requirements of Title 14 of the California Code of Regulations (CCR).

4.1 Regulatory Issues

SMARA (including the State Mining and Geology Board Reclamation Regulations) is flexible with respect to addressing geotechnical slope stability for both fill slopes and cut slopes. SMARA does not specify a minimum factor of safety for slope stability. However, Title 14, Chapter 8, CCR Section 3502(b)(3) indicates that final reclaimed slopes shall be flatter than the critical gradient, which implies that static factors of safety should be greater than 1.0. This section further states “Wherever final slopes approach the critical gradient for the type of material involved, regulatory agencies shall require an engineering analysis of slope stability. Special emphasis on slope stability and design shall be taken when public safety or adjacent property are affected.”

For fill slopes, Section 3704 (d) states that fill slopes shall be 2H:1V or flatter. Slopes steeper than 2H:1V must be supported by site-specific geologic and engineering analyses to indicate that the minimum factor of safety is suitable for the proposed end use. For the Permanente Quarry, the proposed end use is undeveloped open space.

The proposed overall slopes for the EMSA are between 2.5H:1V and 2.6H:1V overall with interbench slopes of 2H:1V. Therefore, slope stability analyses are not explicitly required from a SMARA perspective for this project. However, due to the complex geological conditions of the region, the size of the EMSA fills, and the regional seismicity, it is Golder’s opinion that prudent engineering of the EMSA will include slope stability analyses.

For this project, slope stability of the EMSA does not have the potential to adversely impact adjacent property or public safety. Therefore, we consider a minimum static factor of safety of 1.3 appropriate for the EMSA rock fill. For seismic conditions, permanent seismically induced displacements of less than 2 to 3 feet under the design earthquake conditions were set as the seismic stability criterion.

4.2 Approach and Assumptions

4.2.1 Methodology

Golder completed static and seismic slope stability analyses to evaluate stability conditions of the proposed reclaimed slopes of the EMSA. The slopes of the EMSA at the conclusion of the Phase C reclamation represent the most critical condition for slope stability. The computer program SLIDE 5.0 (Rocscience, 2003) was used to calculate the factors-of-safety against potential slope failures. This program uses two-dimensional, limit-equilibrium theory to calculate safety factors (FOS) for slope stability problems. This program allows both circular and noncircular sliding surfaces to be either defined or generated automatically. Spencer’s Method was used for FOS calculations.

Pseudo-static analyses were performed to evaluate slope stability under earthquake loading. In a pseudo-static limit equilibrium analysis, a lateral force is added to a potential failure mass, with magnitude equal to some fraction of the weight of the slide mass. The fraction is defined in the form of a seismic coefficient, which is typically assumed to be less than the peak ground acceleration and is expressed as a percentage of gravity. Selection of a seismic coefficient and allowable factor of safety was based on the recommendations by Seed (1979), i.e., $k_s = 0.10$ for earthquakes of magnitude 6-1/2 or less, and $k_s = 0.15$ for earthquakes of magnitude as great as 8-1/4, with an

acceptable FOS on the order of 1.15. If the calculated FOS is greater than the acceptable value, the slope is expected to experience acceptable deformation; if the calculated factor of safety is below the acceptable, a more rigorous method, such as dynamic deformation analyses, is performed.

Dynamic deformation analyses were performed using a predictive model recently developed by Bray and Travasarou (2007). The Bray and Travasarou model is a semi-empirical simplified model for estimating permanent displacements due to earthquake-induced deviatoric deformations. The Bray and Travasarou model can also be implemented within a fully probabilistic framework or be used deterministically to evaluate seismic displacement potential. The following equation is used by Bray and Travasarou (2007) to predict the seismic displacement (D) assuming potential slide mass is a rigid sliding block:

$$\ln(D) = -0.22 - 2.83 \ln(k_y) - 0.333 (\ln(k_y))^2 + 0.566 \ln(k_y) \ln(PGA) + 3.04 \ln(PGA) - 0.244 (\ln(PGA))^2 + 0.287 (M - 7) \pm \varepsilon$$

Where, D = seismic displacement in cm

k_y = yield coefficient

PGA = peak ground acceleration

M = moment magnitude

ε = normally distributed random variable with zero mean and standard deviation $\sigma = 0.67$.

4.2.2 Modeling Inputs and Assumptions

4.2.2.1 *Model Geometries*

Sections E1 and E3 for the EMSA (Figure 6) were used as representative sections for stability evaluation. These sections were developed based on pre-storage and current topographic maps, and proposed reclamation designs, provided by Lehigh, as well as on subsurface investigations performed by Golder.

4.2.2.2 *Material Properties*

The following units were included in the stability modeling of the EMSA:

- **Coarse Waste Fill:** For cohesionless rock materials characteristic of the coarse waste at the site, the angle-of-repose of waste fill slopes is often used to approximate the shear strength of a rock material. Based on review of existing topographic maps, the angle-of-repose of the WMSA and EMSA fills generally ranges from 34 degrees to 37 degrees, and averages around 35 degrees. Assuming a cohesion value of zero, this corresponds with an internal friction angle of approximately 35 degrees. Accordingly, coarse waste was assigned average strength parameters based on an internal friction angle of 35 degrees and no cohesion. This friction angle is slightly lower than the value of 36 degrees that Mines Group used (MGI, 2001). A moist unit weight of 125 pcf was assumed for stability modeling.

- **Foundation Soils:** According to the subsurface investigation summarized in Section 3, the foundation soils beneath the proposed EMSA are generally characterized as “a sandy clay to clayey sand with gravel to a silty or clayey gravel with sand”. Based on in-situ strength characterization performed using Standard Penetration Testing (SPT), an internal friction angle of 28 degrees with no cohesion was conservatively used to represent the mean drained strength of the Foundation Soil under the EMSA for long-term stability modeling. An average thickness of 10 ft and a moist unit weight of 120 pcf were assumed.
- **Bedrock:** As discussed in Section 3.1.3, a shear strength characterized with a cohesion of 10 psi or 1,440 psf and a friction angle of 23 degrees was used in stability models to represent the Greenstone in Section E1 in accordance with Golder (2008) and the Greywacke in Section E3.

The material properties used for stability modeling are summarized in Table 1.

4.2.2.3 Water Level

Available historical data indicate groundwater depths ranging from approximately 40 feet to over 200 feet below ground surface. No groundwater was encountered in any of the Golder borings drilled at the EMSA in 2007. Golder conservatively assumed that permanent groundwater is approximately 30 ft to 100 ft below existing ground surface with water levels more shallow at the toe of the proposed waste fill slope. The estimated groundwater depths do not adversely affect the stability of the EMSA slopes.

4.2.2.4 Seismic Parameters

Consistent with previous discussions, the waste fill reclamation stability modeling was based on the following seismic parameters:

- Horizontal seismic coefficient of 0.15g;
- Design Moment Magnitude: $M_w = 6.8\sim 7.1$; and
- Peak horizontal ground acceleration (a_{max}) = 0.6 g (Golder, 2007).

4.3 Static Analyses

4.3.1 Static Stability Conditions of EMSA

As shown in Figure 2, the proposed reclamation plan for the EMSA has overall slopes no steeper than 2.5H:1V to 2.6H:1V and inter-bench slopes no steeper than 2H:1V. Sections E1 and E3 were developed as a representative section to evaluate the stability of the proposed EMSA reclamation slopes. The static stability modeling results were presented in Appendix C. The calculated FOS values against potential multi-bench failure (or global failure) are 1.69 for Section E1 and 1.73 for Section E3, which exceed the minimum static slope stability design criterion of 1.3. The calculated FOS against potential inter-bench slope failure is approximately 1.42, which also exceeds the acceptable minimum FOS value.

4.4 Seismic Analyses

The pseudo-static limit equilibrium analyses for Sections E1 and E3 with the horizontal seismic coefficient of 0.15g are shown in Appendix C (see Appendices C-3 and C-4), which indicate that the minimum FOS against global failure is about 1.16 for Section E1 and 1.12 for Section E3. Seismic displacement analyses (Table 2) were completed on Section E3, which is the more critical section with respect to seismic slope stability. The computed permanent slope deformations could range between 2-inches and 8-inches with an average of approximately 4-inches.

The pseudo-static limit equilibrium analyses on potential inter-bench failure result in a computed minimum FOS of approximately 1.01 to 1.02. Seismic displacement analyses (Table 2) estimate that the potential inter-bench permanent slope deformation could range between 3-inches and 13-inches with an average of 6-inches. The inter-bench seismic displacement is anticipated to be shallow and will be contained with the 25-foot wide benches between lifts.

4.5 Additional Analyses

Additional slope stability analyses were completed to address specific waste storage area construction requirements.

4.5.1 Presence of Fine Waste

The washing of limestone aggregate produces a fine waste material that consists of an unconsolidated saturated clayey silt (ML) and silty clay (CL). The fine waste fill is placed in the middle portion of the waste storage areas in lifts no higher than 8 feet. These lifts are then covered by at least a 25-foot thick lift of coarse waste. The fine waste is maintained at a minimum offset of 30 feet from the final outer slope of the waste storage area.

To evaluate the impact of the fine waste deposit on local slope stability, slope stability analyses were completed. The drained strength of the fine waste was modeled using Mohr-Coulomb shear strength envelope characterized by an internal friction angle of 28 degree with no cohesion. This assumed shear strength is consistent with the results of the soil index laboratory tests and slightly lower than the results from two consolidated undrained (CU) triaxial tests performed on the fine waste material (Appendix B).

The stability modeling results shown in Appendix C-5 indicate that under static conditions, block failures through fine waste will unlikely become critical or controlling failure paths and the local stability of the EMSA slope with the fine waste fill is unlikely affected by the presence of the fine waste fill provided the fine wastes remain drained.

Pseudo-static analysis was also performed to evaluate the stability of the EMSA with the fine waste fill. Since the fine waste fill mostly consists of clay and silt and could be locally or partially saturated due to its relatively lower permeable nature, a strength reduction of 20 percent was conservatively applied to the peak undrained strength for seismic stability modeling. As shown in Appendix C-5, the calculated minimum FOS against local block failures through Fine Waste is approximately 0.91. Seismic slope displacement analyses (Table 2) indicate that the permanent slope deformation caused by the design earthquake loading is estimated to be between 6 and 24-inches, with a mean displacement of 12-inches, which is within the acceptable displacement criterion.

4.5.2 Subgrade Preparation

The placement of the EMSA materials on organic rich topsoil, soft or clayey colluvium, or over saturated soils could result in foundation soil conditions with lower effective shear strengths than assumed in this study. A series of slope stability analyses were completed to determine the extent of foundation improvements that should be completed for the EMSA construction.

Based on the results of these analyses, Golder concludes that foundation preparation should be completed on the outer 50 feet of the EMSA fill. The foundation preparation should include over-excavation of the upper topsoil, organic debris, and fine grained colluvium with high plasticity index to expose firm bedrock, granular soils or lean clay. In areas where the outer 50 feet of the footprint is founded on a native slope that is steeper than 5H:1V, the topsoil and colluvium over-excavation should be extended to 100 feet from the outer slope. Appendices C-6 through C-9 present the slope stability analyses.

5.0 CONCLUSIONS AND RECOMMENDATIONS

5.1 Conclusions

Based on previous studies and investigations, laboratory testing, and slope stability analyses completed by Golder, the following conclusions are provided for the EMSA:

- The EMSA will be reclaimed as undeveloped open space and will not pose a threat to public safety or to adjacent properties.
- The static FOS for global slope stability is approximately 1.7. The static FOS for the 2H:1V slope between benches is 1.4. These values exceed the minimum factor of safety of 1.3 criterion for static conditions established for the EMSA.
- Permanent, seismically-induced displacements are estimated to be an average of 6-inches or less for the waste rock fill. These displacements could average 12-inches when considering the placement of fine waste material in maximum 8-foot lifts with an offset of 30 feet from the final outer slope face. These computed displacements are well within the maximum displacement criterion of 2 to 3 feet for the EMSA.

Therefore, the proposed reclaimed EMSA slopes are stable under static and the design seismic loading conditions.

5.2 Recommendations

Golder recommends implementing the following recommendations during construction of the EMSA:

- Foundation preparation should be completed prior to fill placement of the outer 50 feet beneath the EMSA fill. Foundation preparation should consist of over-excavation of outer 50 feet of topsoil, organic materials (trees, brush, grasses), fine-grained colluvium with a Plastic Index greater than 25, or other unsuitable soils until firm bedrock, granular soils, or clay soils with a Plastic Index less than 25 are exposed. If the exposed foundation surface is inclined at 5H:1V or steeper, the over-excavation distance from the outer slope should be extended from 50 feet to 100 feet. Furthermore, the fill placed on slopes of 5H:1V or steeper should be benched into the slope with individual bench heights of at least 2 feet and up to approximately 5 feet. Figure 7 illustrates the subgrade preparation requirements.
- A qualified California Professional Geologist, Certified Engineering Geologist, or a California Registered Civil Engineer with geotechnical experience should inspect the foundation preparation to ensure all unsuitable materials are removed prior to placement of the outer 50 to 100 feet of EMSA fill.
- If seepage or wet zones are observed in the foundation, suitable drainage provisions should be incorporated into the foundation prior to fill placement. Suitable drainage provisions include the placement of a blanket of free-draining sand or gravel over the seepage/wet zone in conjunction with a perforated, polyvinyl (PVC) or high-density polyethylene (HDPE) drain pipe that drains positively toward and daylight at the slope face. The sand or gravel drainage material should be fully covered with a minimum 8-oz/square yard, non-woven, geotextile filter to provide separation from the EMSA materials.

- The fine waste materials should be placed in maximum 8-foot thick lifts and offset a minimum of 30 feet from the final slope face. Each lift of fine waste should be covered by a minimum 25-foot thick lift of waste rock.
- Golder should be contacted to review any modifications to EMSA fill geometry including increases to the maximum overall slope inclination, maximum inter-bench slope inclination, slope height, or footprint. Such modifications may require further slope stability analyses.

6.0 LIMITATIONS

This report has been prepared for the exclusive use of Lehigh Southwest Cement Company for specific application to the evaluation of the EMSA slope reclamation for compliance with SMARA. The findings, conclusions, and recommendations presented in this report were prepared in accordance with generally accepted geotechnical engineering practice that exists within the area at the time of the work. No other warranty, expressed or implied, is made.

The analyses and recommendations contained in this report are based on data obtained from the results of previous subsurface explorations by others as well as the explorations and mapping conducted by Golder. The methods used generally indicate subsurface conditions at the time and locations explored and sampled. Boring logs may not reflect strata variations that may exist between all sampling locations. In addition, groundwater conditions can vary with time.

7.0 REFERENCES

- Bray, J. D., and Travasarou, T. (2007), "Simplified Procedure for Estimating Earthquake-Induced Deviatoric Slope Displacements", *Journal of the Geotechnical and Geoenvironmental Engineering*, ASCE, Vol. 133, No. 4, pp. 381-392.
- Call and Nicholas Inc. (CNI, 1998), "Slope Stability Analysis Northwest Wall of the Permanente Quarry", Report Prepared for Hanson Permanente Cement Company, Dated February 1998.
- Call and Nicholas (2002a), "Slope Stability Study, East Wall of Hanson Permanente Quarry," prepared for Hanson Permanente Cement, dated August, 2002.
- Call and Nicholas (2002b), "Addendum 1 - Slope Stability Study, East Wall of Hanson Permanente Quarry," letter report to David Disbrow, dated October 14, 2002.
- Foruria, J., 2004. Geology of the Permanente Limestone and Aggregate Quarry, Santa Clara County, California. Report prepared for Hanson Permanente Cement dated September 24, 2004.
- Gibson, R. E. (1953), "Experimental Determination of the True Cohesion and True Angle of Internal Friction in Clays", *Proceedings, 3rd Internal Conference on Soil Mechanics and Foundation Engineering*, Zurich, Switzerland, pp. 126-130.
- Golder Associates Inc (2007), "Plan Review, East of Quarry Wall- Mid-Peninsula Slope Stability Re-grading Plan, Hanson Permanente Quarry, Cupertino, California," prepared for EnvironMINE, Inc, dated January 4, 2007.
- Golder Associates, Inc., (2008), "Slope Stability Evaluation for Compliance with SMARA, West Materials Storage Area, Permanente Quarry, Santa Clara County, California", Report prepared for Hanson Aggregates, dated November 2008.
- Mathieson, E.L., 1982, Geology of the Permanente Property, Kaiser Corporation, Permanente, California, unpublished Kaiser Permanente Cement Company report, 34 p.
- Mines Group, Inc (2001), "Hanson Permanente Cement, Waste Rock Dump Conceptual Drainage, Sediment Control, and Reclamation Design", Report prepared for Hanson Permanente Cement dated November 19, 2001.
- Rocscience, "SLIDE 5.0", Manual and Software, 2003.
- Rogers, T.H. and Armstrong, C.F., 1973, Environmental Geologic Analysis of the Monte Bello Ridge Mountain Study Area, Santa Clara County, California, California Division of Mines and Geology Preliminary Report 17.
- Seed, H. B. (1979), "Considerations in the Earthquake-Resistant Design of Earth and Rockfill Dams," *Geotechnique*, vol. 29, No. 3, pp. 215-263.
- Sorg, D.H., and McLaughlin, R.J., 1975. Geologic Map of the Sargent-Berrocal Fault Zone Between Los Gatos and Los Altos Hills, Santa Clara County, California: U.S. Geological Survey Miscellaneous Field Studies Map MF-643, scale 1:24,000
- United States Department of Agriculture, Forest Service, "Level I Stability Analysis Documentation for Version 2.0," General Technical Report INT-285, April 1992.

United States Department of Agriculture, Forest Service, "Slope Stability Reference Guide for National Forests in the United States, Volume II," EM 7170-13, August 1994.

Vanderhurst, W., 1981, The Santa Clara Formation and Orogenesis of Monte Bello Ridge, 114 p.

TABLES

TABLE 1
MATERIAL PROPERTIES FOR STABILITY ANALYSES

Material	Unit Weight, pcf	Drained Strength		Undrained Strength	
		Cohesion c' , psf	Friction Angle ϕ' , °	Cohesion c , psf	Friction Angle ϕ , °
Coarse Waste Fill ¹	125	0	35	0	35
Foundation Soil – EMSA ²	120	0	28	0	28
Bedrock ³	165	1,440	23	1,440	23
Fine Waste Fill ⁴	110	0	28	0	18

Notes:

1. Design values assumed based on back analyses and field observations;
2. Design values based on in-situ strength characterization and correlation recommendation in literatures;
3. Design values based on review of past studies (Golder, 2008);
4. Design values based on laboratory testing data and correlation recommendation in literatures.

TABLE 2
Summary of Dynamic Deformation Analysis

Selected Notations			
M_w =	Moment magnitude	k_y =	Yield acceleration
a_{brk} =	Peak Horizontal Acceleration at the bedrock	U =	Dynamic deformation along critical slide surface
a_{max} =	Peak Horizontal Acceleration at the crest of slope		

Earthquake Characterization		
M_w	a_{brk}	a_{max} (Reference 1)
	g	g
7.1	0.60	0.60

Deformation Calculation (Reference 2)							
SITE	Section	Failure Modes	k_y	k_y/a_{max}	Slope Deformation, U (in) (Bray and Travasarou)		
			g		84% Exc.	16% Exc.	50% Exc.
EMSA	E1	Inter-Bench	0.16	0.27	3	13	6
	E3	Inter-Bench	0.16	0.27	3	13	6
	E3	Global Stability	0.20	0.33	2	8	4
Mud Dump	Conceptual	Local Block Failure	0.11	0.18	6	24	12

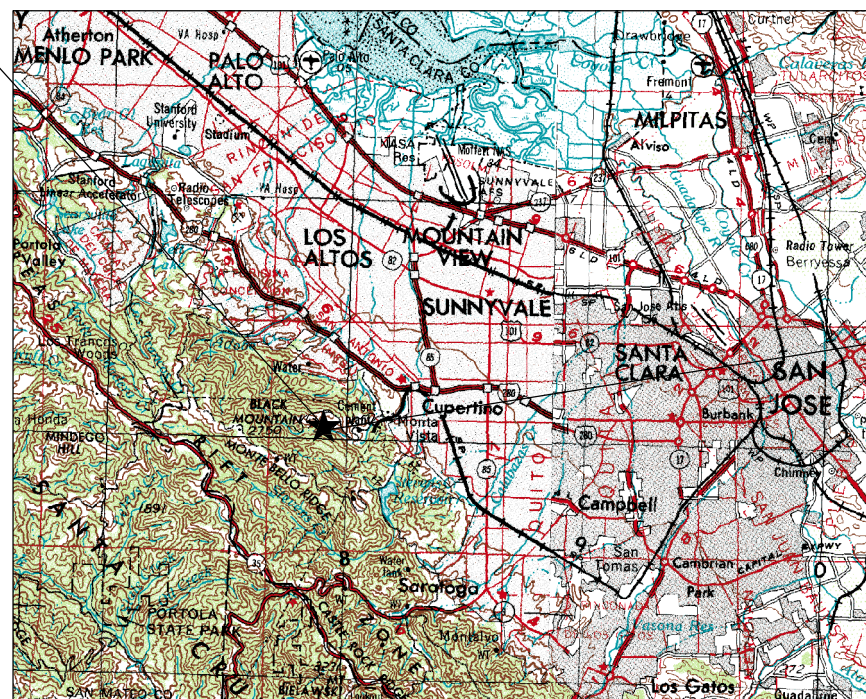
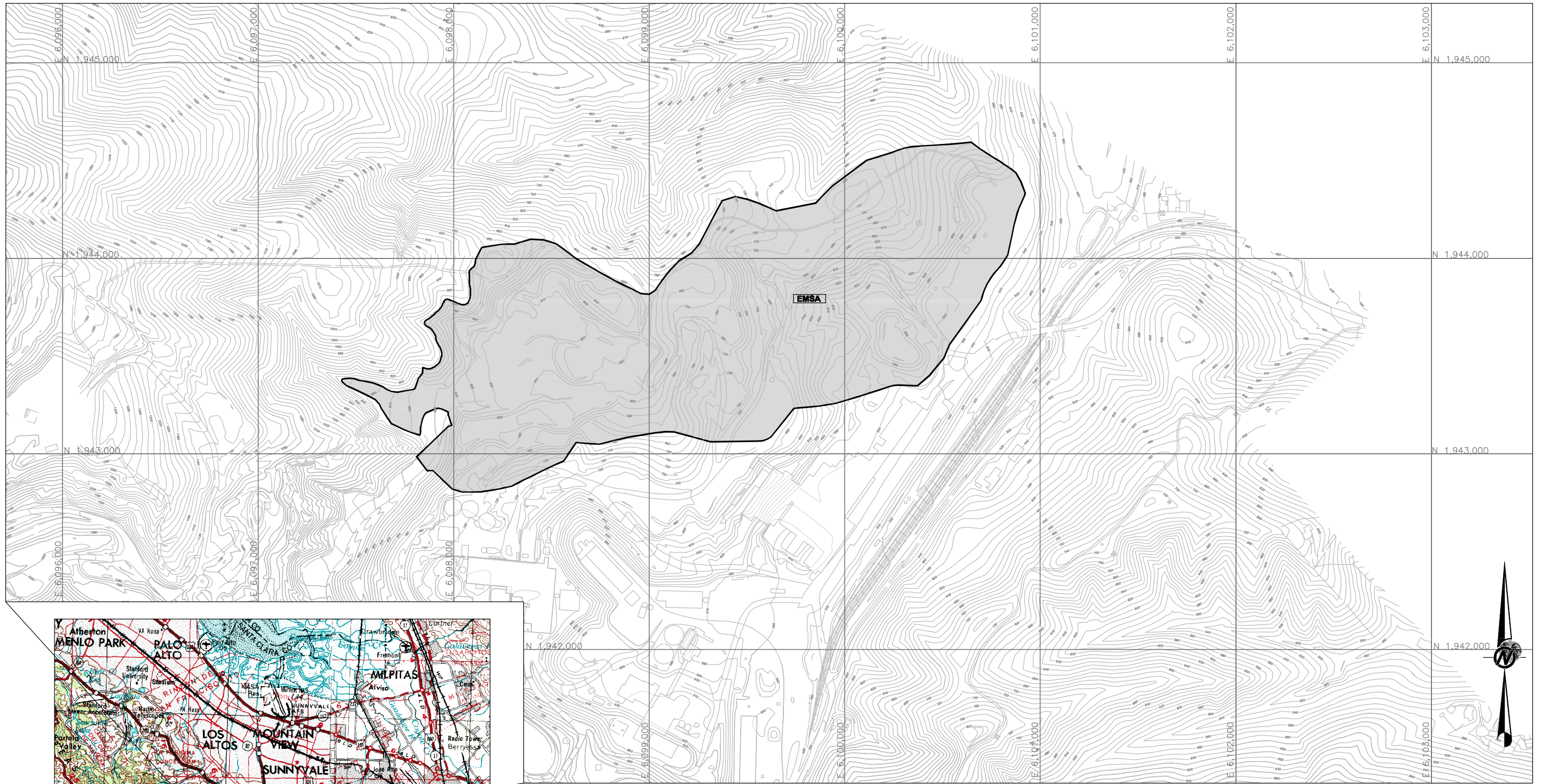
References:

1. Seed, H. B. and Idriss, I. M. (1982), Ground Motions and Soil Liquefaction During Earthquakes Monograph No. 5, Earthquake Engineering Research Institute, Berkeley, California.
2. Bray, J. D. and Travasarou, T. (2007), Simplified Procedure for Estimating Earthquake-Induced Deviatoric Slope Displacement Journal of the Geotechnical and Geoenvironmental Engineering, ASCE, Vol. 133, No. 4, pp. 381-392.

Note: This spreadsheet is only intended to estimate seismic deformation under the above shown earthquake events and sections.

FIGURES

Drawing file: Figure 1.dwg Apr 09, 2009 - 4:43pm



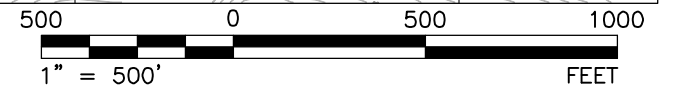
MAP OF REGION


LEGEND

- ★ PROJECT LOCATION
- APPROXIMATE LIMIT OF STUDIED AREA

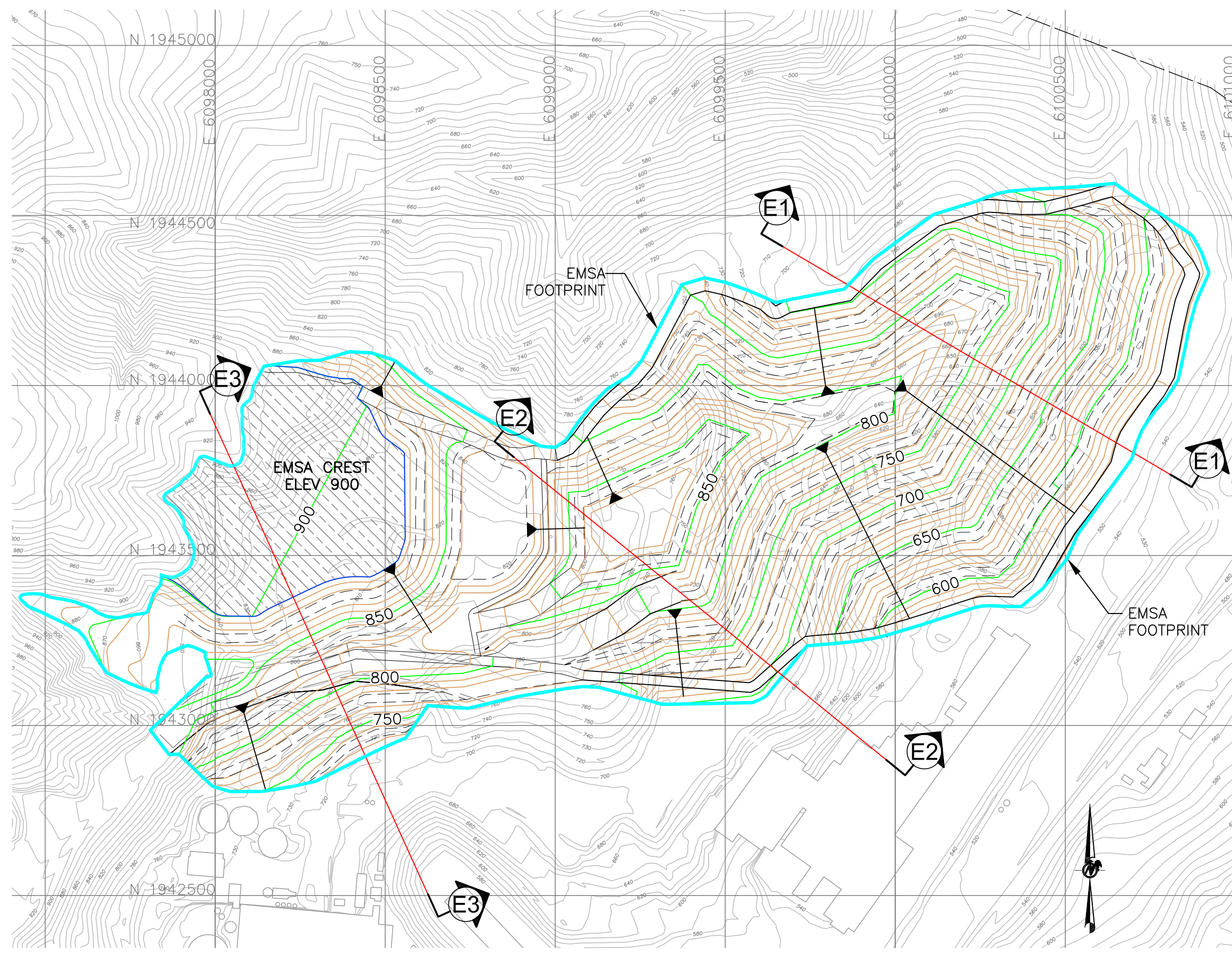
NOTE

1. REGIONAL MAP BASED FROM USGS 250K QUAD MAPS:
 - SAN FRANCISCO, 1980
 - SAN JOSE, 1969



PROJECT		PROPOSED RECLAMATION PLAN EAST MATERIALS STORAGE AREA LEHIGH SOUTHWEST CEMENT COMPANY, CALIFORNIA		
TITLE		SITE LOCATION MAP		
 Golder Associates Sunnyvale, California	PROJECT No.	063-7109	FILE No.	FIGURE 1
	DESIGN	PHY	03/09	SCALE AS SHOWN
	CADD	CJM	03/09	REV. A
	CHECK	PHY	03/09	
	REVIEW	KGH	03/09	
FIGURE 1				

Drawing file: Figure 2.dwg Apr 08, 2009 - 3:17pm



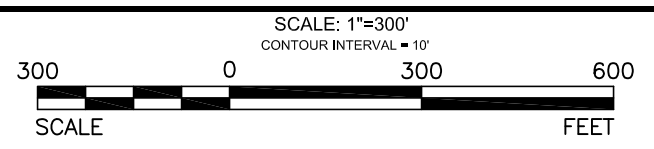
LEGEND

- PREDUMP TOPOGRAPHY AS OF APRIL 2007 (10 FT INTERVAL)
- EMSA DESIGN TOPOGRAPHY
- ADJACENT STRUCTURES AND FACILITIES
- SECTION ID
- EMSA CREST ELEV. 900
- EMSA FOOTPRINT

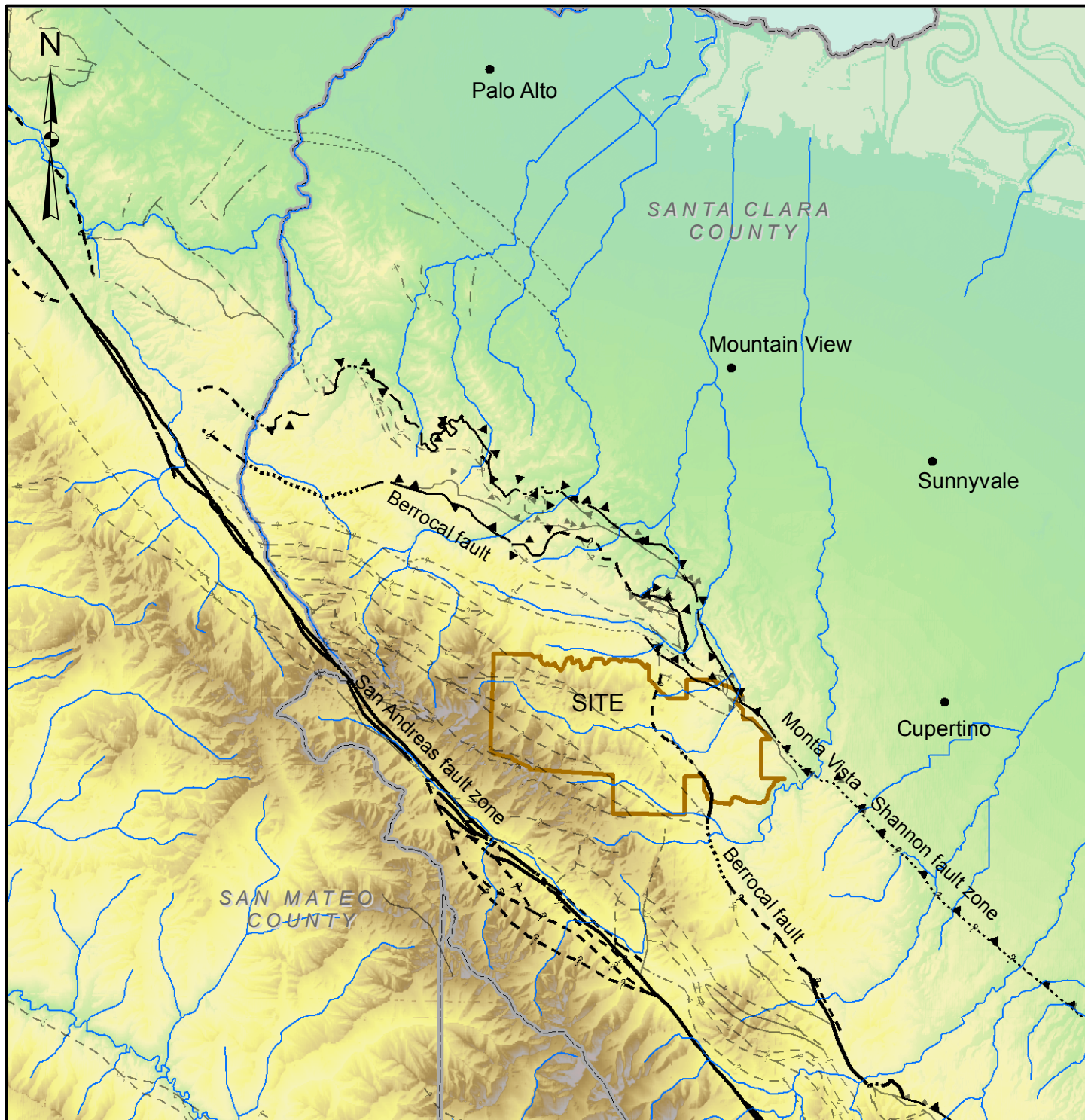
NOTE

1. PRE-DUMP TOPOGRAPHIC INFORMATION PROVIDED BY HAMMON, JENSEN, WALLEN AND ASSOCIATES. DATE OF TOPOGRAPHY: 4-9-07.

EAST MATERIALS STORAGE AREA SITE PLAN



PROJECT		PROPOSED RECLAMATION PLAN EAST MATERIALS STORAGE AREA LEHIGH SOUTHWEST CEMENT COMPANY, CALIFORNIA		
TITLE		SITE PLAN EAST MATERIALS STORAGE AREA		
	PROJECT No.	063-7109	FILE No.	FIGURE 2
	DESIGN	PHY	03/09	SCALE AS SHOWN
	CADD	CJM	03/09	REV. A
	CHECK	PHY	03/09	FIGURE 2
REVIEW	KGH	03/09		



LEHIGH SOUTHWEST CEMENT COMPANY



Legend

- Stream
- Fault (surface expression):**
 - Certain
 - Concealed
 - Inferred
 - Thrust (teeth in dip direction)
Dashed where approx., queried where uncertain; dotted where concealed.

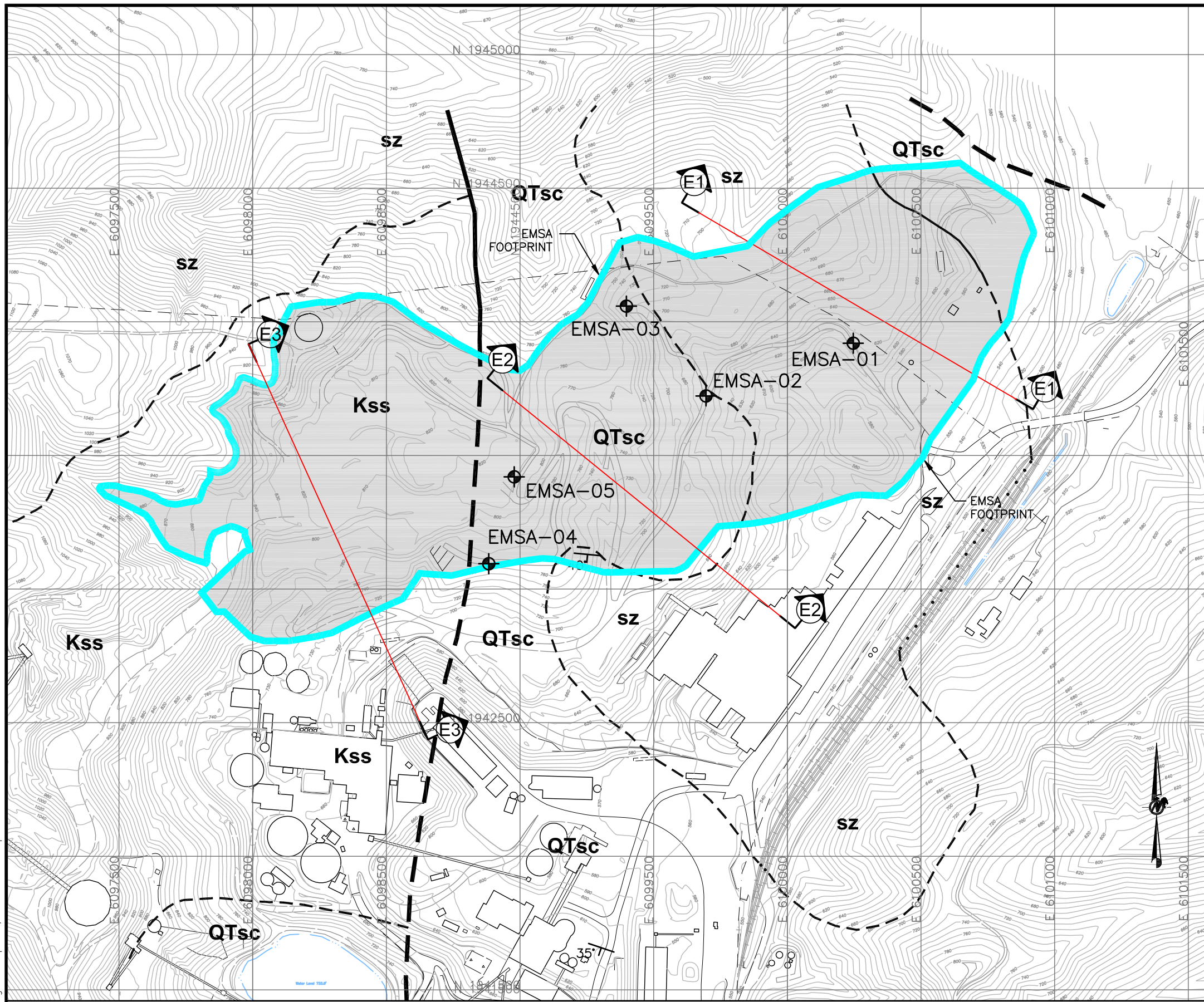
Fault source: Brabb, et. al. (2000)
 Faults discussed in text have heavier line weight.

REV.	DATE	DES	REVISION DESCRIPTION	GIS	CHK	RVW
PROJECT: PROPOSED RECLAMATION PLAN EAST MATERIALS STORAGE AREA LEHIGH SOUTHWEST CEMENT COMPANY, CA						
TITLE: REGIONAL GEOTECTONIC SETTING						
PROJECT No. 063-7109			FILE No.			
DESIGN	DLM	3/13/2009	SCALE: AS SHOWN		REV. 0	
GIS	DLM	3/13/2009	FIGURE 3			
CHECK	WLF	3/25/2009				
REVIEW	WLF	3/25/2009				



G:\Projects\063-7109 (Hanson Permanent Quarry)\GIS\Hanson_geotectonic_map_20Mar2009.mxd

Drawing file: Figure 4.dwg Apr 08, 2009 - 5:28pm



LEGEND

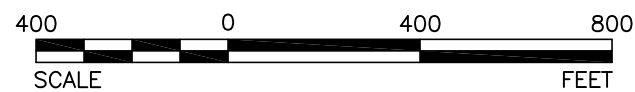
- GEOLOGIC CONTACT, CERTAIN
- - - - - GEOLOGIC CONTACT, APPROXIMATE
- GEOLOGIC CONTACT, CONCEALED
- FAULT CONTACT, CERTAIN
- - - - - FAULT CONTACT, APPROXIMATE
- 35° ↘ STRIKE AND DIP OF BEDDING
- QTsc** SANTA CLARA FORMATION
- Kss** FRANCISCAN COMPLEX SANDSTONE (GREYWACKE)
- SZ** SHEAR ZONE, MELANGE OF FRANCISCAN COMPLEX ROCKS – METABASALTS (GREENSTONE), SANDSTONE (GREYWACKE), LIMESTONE, AND SERPENTINE
- ⬆️ **E2** SECTION ID
- ◻ EMSA FOOTPRINT
- ⊕ **EMSA-05** GEOTECHNICAL BOREHOLE – GOLDER, 2007

NOTE

1. GEOLOGY MODIFIED AFTER ROGERS, T.H. AND ARMSTRONG, C.F., 1973, ENVIRONMENTAL GEOLOGIC ANALYSIS OF THE MONTE BELLO RIDGE MOUNTAIN STUDY AREA, SANTA CLARA COUNTY, CALIFORNIA, CALIFORNIA DIVISION OF MINES AND GEOLOGY PRELIMINARY REPORT 17.

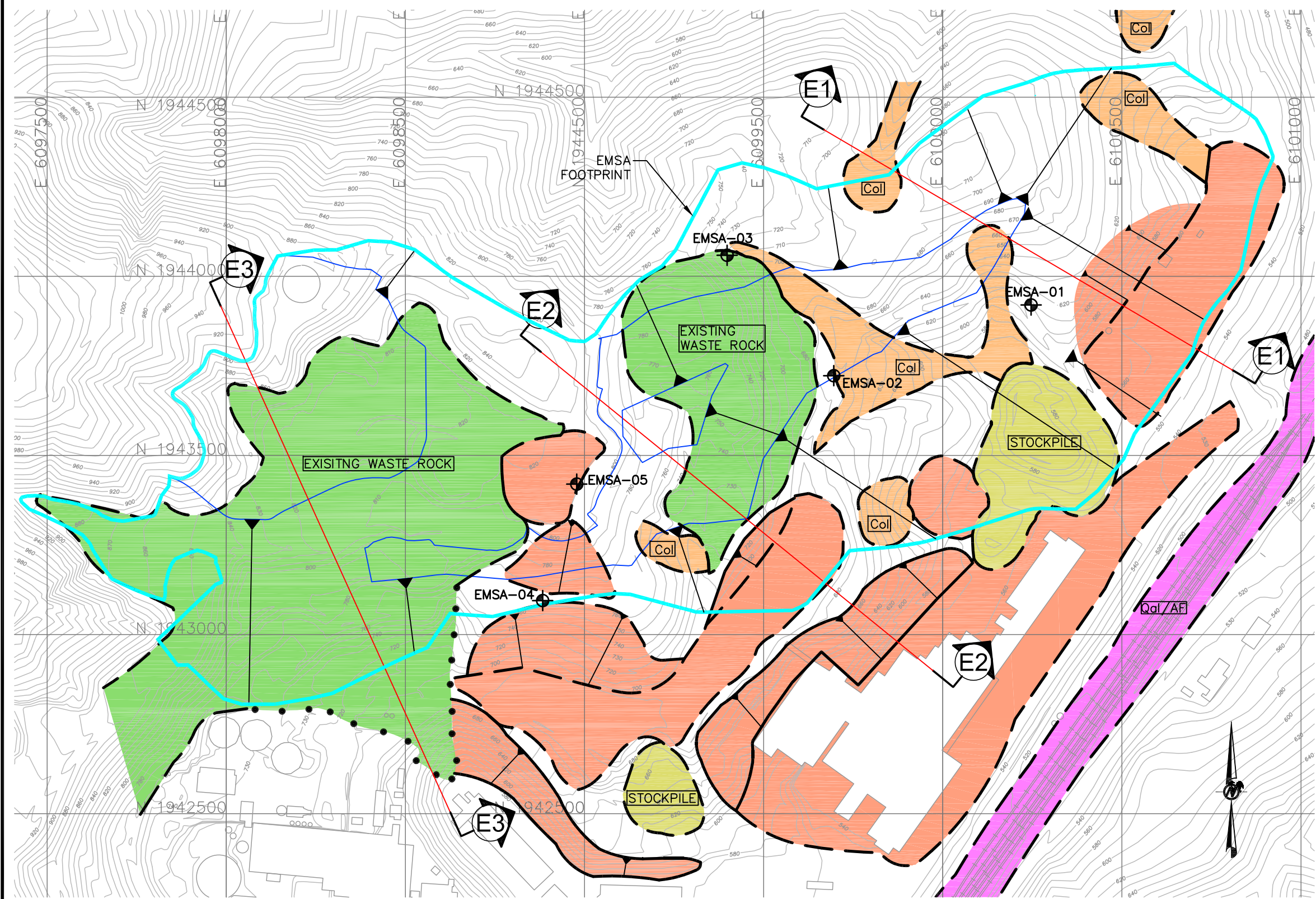
EAST MATERIALS STORAGE AREA GEOLOGIC MAP

SCALE: 1"=400'



PROJECT		PROPOSED RECLAMATION PLAN EAST MATERIALS STORAGE AREA LEHIGH SOUTHWEST CEMENT COMPANY, CALIFORNIA		
TITLE		GEOLOGIC MAP EAST MATERIALS STORAGE AREA		
 Golder Associates Sunnvale, California	PROJECT No.	063-7109	FILE No.	FIGURE 4
	DESIGN	PHY	03/09	SCALE AS SHOWN
	CADD	CJM	03/09	REV. A
	CHECK	PHY	03/09	
REVIEW	KGH	03/09		
FIGURE 4				

Drawing file: Figure 5.dwg Apr 08, 2009 - 5:52pm



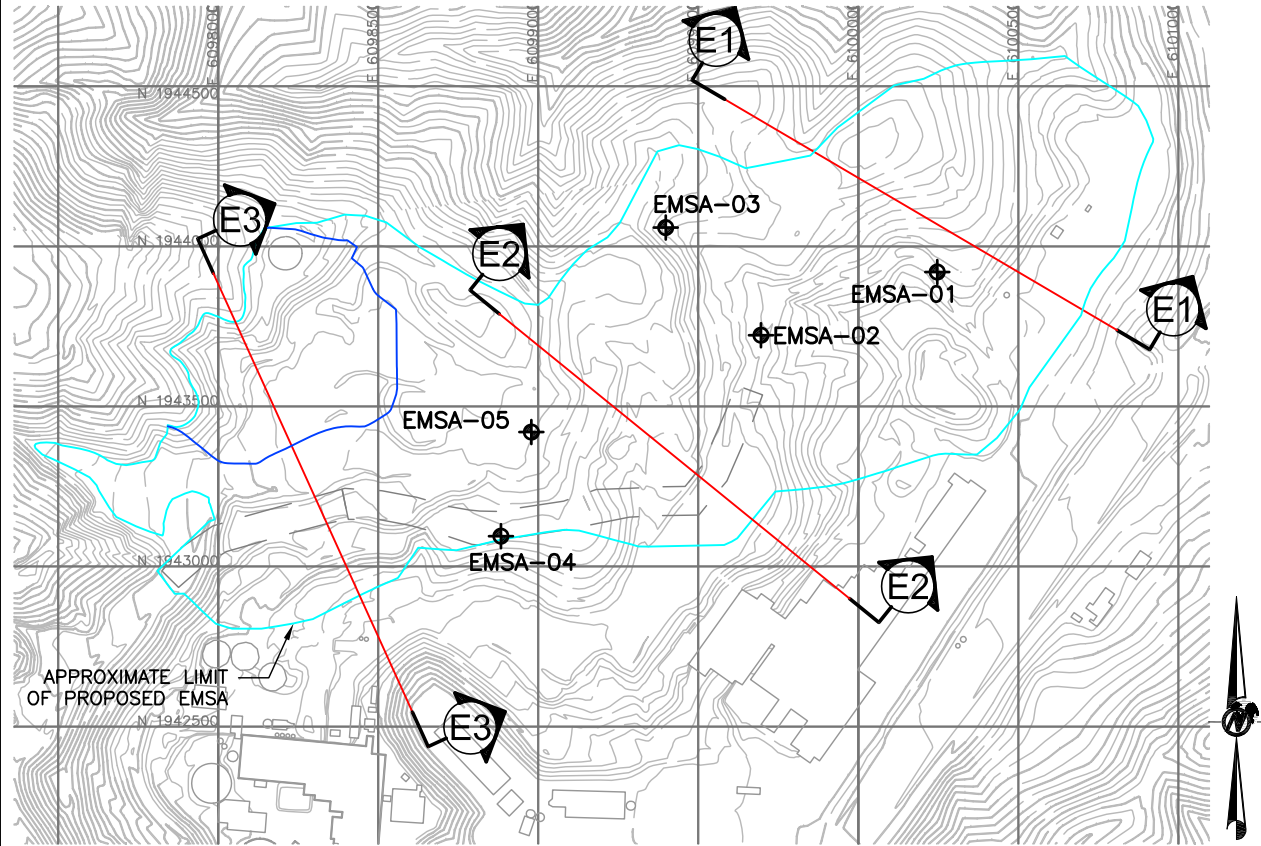
- LEGEND:**
- 1550 PREDUMP TOPOGRAPHY AS OF APR-07 (10 FT INTERVAL)
 - SECTION ID
 - EMSA-05 GEOTECHNICAL BOREHOLE - GOLDER, 2007
 - EMSA FOOTPRINT
 - EMSA CREST
 - COLLUVIUM (>5 FEET THICK)
 - Qal / ARTIFICIAL FILL
 - STOCKPILE
 - EXISTING WASTE ROCK
 - CUT AREA
- SURFACE SEPARATION:**
- CERTAIN
 - APPROXIMATE
 - UNCERTAIN

EAST MATERIALS STORAGE AREA SURFACE MAPPING

SCALE: 1"=300'



PROJECT		PROPOSED RECLAMATION PLAN EAST MATERIALS STORAGE AREA LEHIGH SOUTHWEST CEMENT COMPANY, CALIFORNIA		
TITLE		SURFACE MAPPING EAST MATERIALS STORAGE AREA		
 Golder Associates Sunnvale, California	PROJECT No.	063-7109	FILE No.	FIGURE 5
	DESIGN	PHY	03/09	SCALE AS SHOWN
	CADD	CJM	03/09	REV. A
	CHECK	PHY	03/09	
	REVIEW	KGH	03/09	
FIGURE 5				



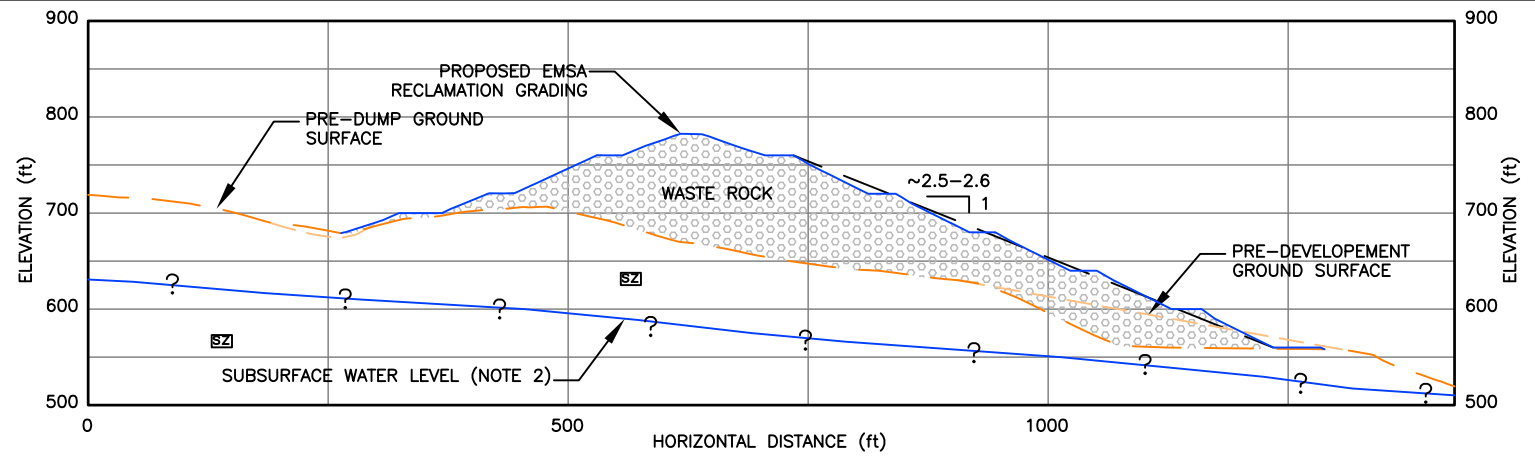
EAST MATERIALS STORAGE AREA SITE PLAN

SCALE: 1"=600'
CONTOUR INTERVAL = 10'



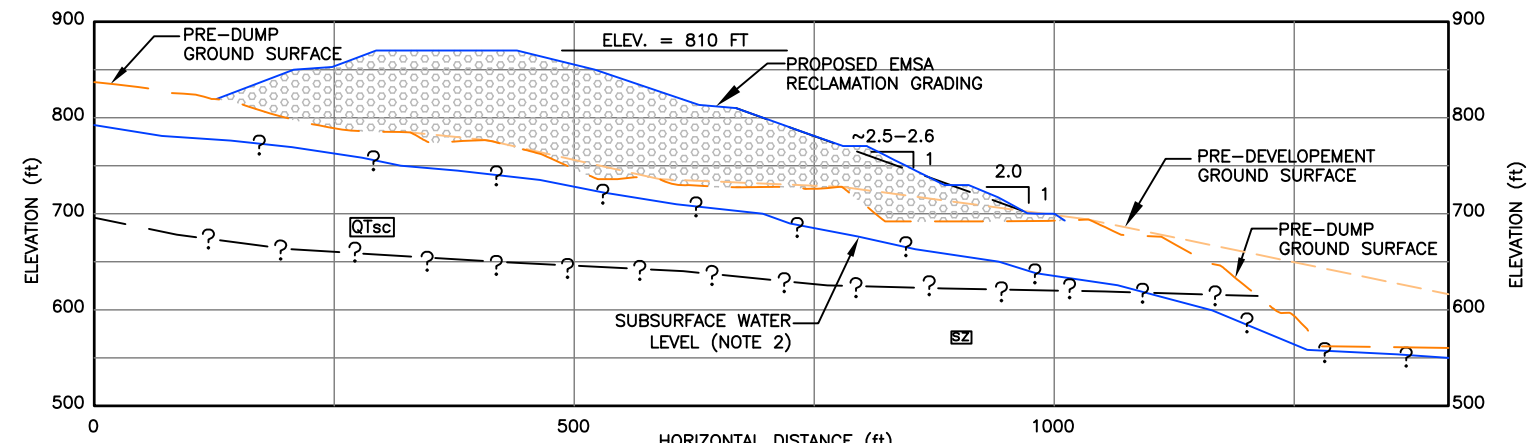
LEGEND

- EXISTING TOPOGRAPHY (10 FT INTERVAL)
- ADJACENT STRUCTURES AND FACILITIES
- SECTION ID/REFERENCE FIGURE NUMBER
- EMSA FOOTPRINT
- EMSA CREST
- SUBSURFACE WATER LEVEL PROFILE (NOTE 2)
- GEOLOGIC UNITS CONTACT PROFILE
- EMSA-05 GEOTECHNICAL BOREHOLE - GOLDER, 2007
- SANTA CLARA FORMATION
- FRANCISCAN COMPLEX SANDSTONE (GREYWACKE)
- SHEAR ZONE, MELANGE OF FRANCISCAN COMPLEX ROCKS - METABASALTS (GREENSTONE), SANDSTONE (GREYWACKE), LIMESTONE, AND SERPENTINE
- ARTIFICIAL FILL



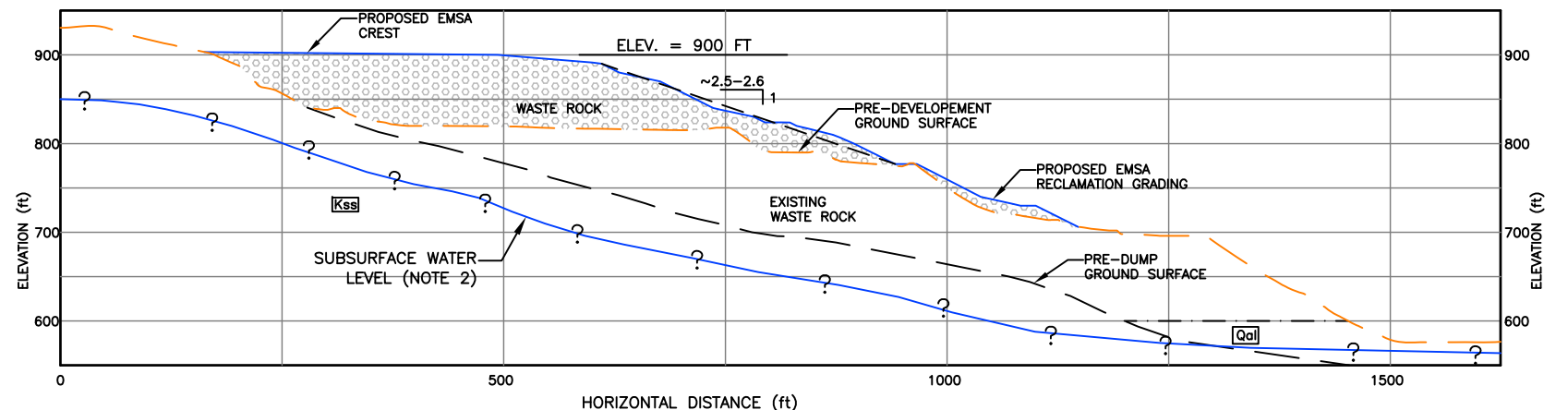
EMSA SECTION E1

SCALE H/V: 1"=200"



EMSA SECTION E2

SCALE: H/V 1"=200'



EMSA SECTION E3

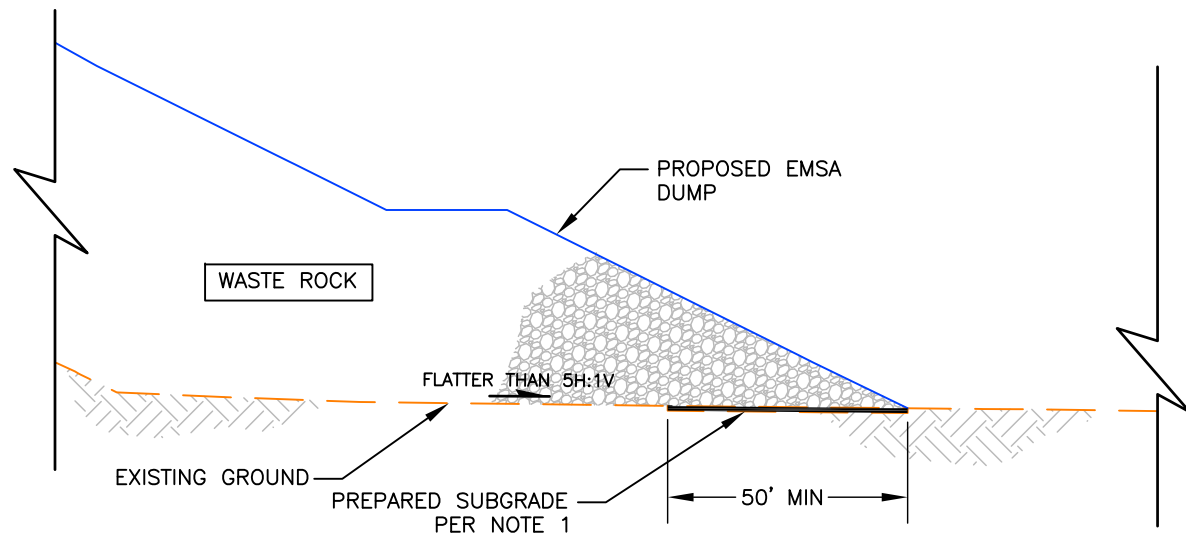
SCALE: H/V 1"=200'



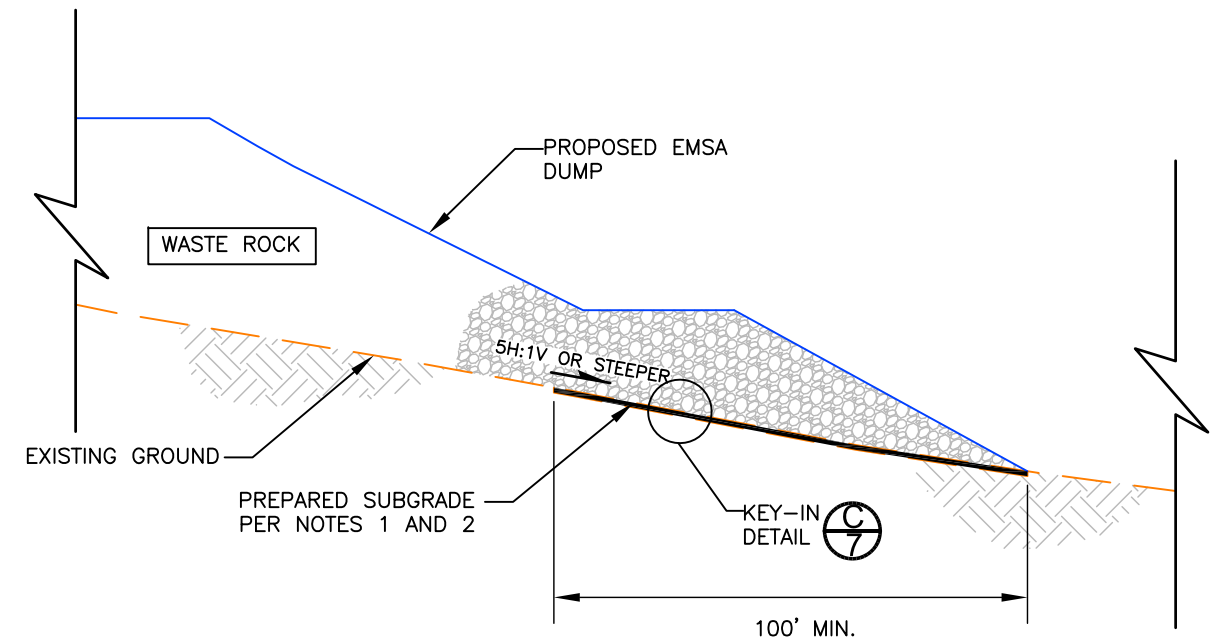
NOTE

- TOPOGRAPHIC INFORMATION PROVIDED BY HAMMON, JENSEN, WALLEN AND ASSOCIATES. DATE OF TOPOGRAPHY: APRIL 9, 2007.
- WATER LEVELS ARE ASSUMED BASED ON SUBSURFACE INVESTIGATIONS BY GOLDER (2007) AND OTHER HISTORIC DATA.

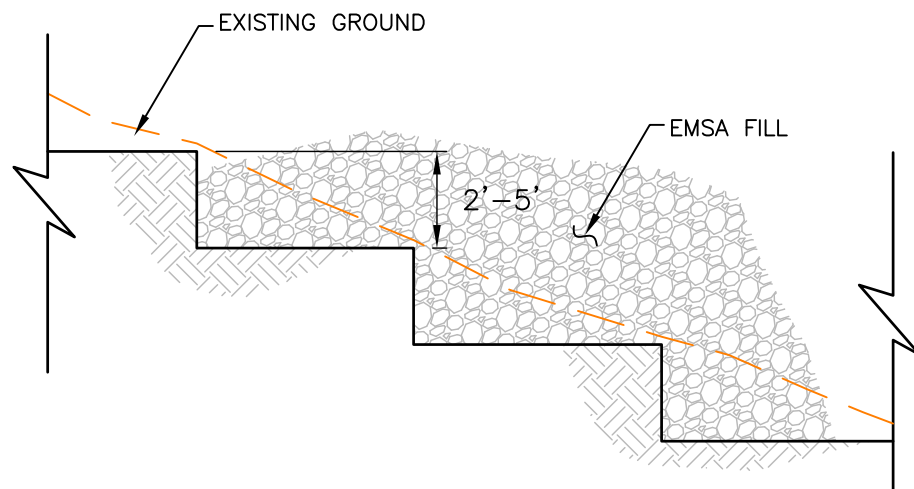
PROJECT		PROPOSED RECLAMATION PLAN EAST MATERIALS STORAGE AREA LEHIGH SOUTHWEST CEMENT COMPANY, CALIFORNIA			
TITLE		CROSS-SECTIONS EAST MATERIALS STORAGE AREA			
	PROJECT No.	063-7109	FILE No.	FIGURE 6	
	DESIGN	PHY	02/09	SCALE	AS SHOWN
	CADD	CJM	02/09	REV.	A
	CHECK	PHY	02/09		
	REVIEW	KGH	02/09		



A SUBGRADE PREPARATION FOR OUTWARD SLOPING
EXISTING GROUND FLATTER THAN 5H:1V
 NTS



B SUBGRADE PREPARATION FOR OUTWARD SLOPING
EXISTING GROUND 5H:1V OR STEEPER
 NTS



C BENCH KEY-IN DETAIL
 NTS

NOTE

1. SUBGRADE PREPARATION SHALL CONSIST OF OVER-EXCAVATION OF TOPSOIL, VEGETATION, AND FAT CLAYS. OVER-EXCAVATION SHALL BE PERFORMED UNTIL BEDROCK, GRANULAR SOIL, OR LEAN CLAY IS ENCOUNTERED. LEAN CLAY SHALL BE MEASURED TO HAVE A PLASTICITY INDEX (PI) NO GREATER THAN 25.
2. SUBGRADE PREPARATION OF SLOPES 5H:1V OR STEEPER SHOULD ALSO CONSIST OF BENCHING THE SLOPES WITH INDIVIDUAL BENCH HEIGHTS OF AT LEAST 5 FEET AS SHOWN IN DETAIL C.

Drawing file: Figure 7.dwg Apr 08, 2009 - 5:49pm

PROJECT		PROPOSED RECLAMATION PLAN EAST MATERIALS STORAGE AREA LEHIGH SOUTHWEST CEMENT COMPANY, CALIFORNIA			
TITLE		SUBGRADE PREPARATION EAST MATERIALS STORAGE AREA			
PROJECT No.		063-7109		FILE No.	
DESIGN	PHY	03/09	SCALE	AS SHOWN	FIGURE 7
CADD	CJM	03/09	REV.	A	
CHECK	PHY	03/09	FIGURE 7		
REVIEW	KGH	03/09			



APPENDIX A

GEOTECHNICAL BORING LOGS

SUMMARY: BORING NO. EMSA-1

SHEET 1 OF 3

DATE DRILLED: 5/21/07 - 5/21/07

COORDINATES: N 1,943,921.0 FT
E 610,028.0 FT

DRILLING METHOD: CME 75 / 6" Hollow Stem Auger / SPT-Automatic 140LB Hammer

SURFACE CONDITIONS: Sand AND gravel to 3" diameter, dry

ELEVATION: 614.0 FT

DEPTH IN FEET	SAMPLE NO.	RECOVERY	BLOWS/6"	SAMPLE TYPE	LAB MOISTURE % OF DRY WEIGHT	LAB TEST	LITHOLOGY	DESCRIPTION	SYMBOL	MOISTURE	CONSISTENCY	DEPTH IN FEET
0												0
5	EMSA-1-5 EMSA-1-(5-7)	4 4 6	4 4 6	SPT Shelby		G G	CLAYEY SAND (SC) w/ few gravel, dark brown, gravel to 1" diameter, loose, dry		SC	dry	medium dense	5
10	EMSA-1-10	12 13 18	12 13 18	SPT		A, G	LIMESTONE (low grade), grey, to 3" diameter, subangular, medium weathered, hard, dry		LS		dense	10
15		5 10 15	5 10 15	SPT			GREENSTONE, dark brown/green, to 2" diameter, subangular, fine grained, medium to highly weathered, hard, dry		GS		medium dense	15
20	EMSA-1-20	10 19 21	10 19 21	SPT		A, G	LIMESTONE (low grade), grey/dark red, to 3" diameter, fine grained, subangular, some calcite fractures, medium weathered, hard, dry		LS		medium dense	20
							GREENSTONE, green, to 1.5" diameter, fine grained, subrounded, trace calcite, medium weathered, dry		GS		dense	20

Continued Next Page

- A. 2" O.D. SPLIT-SPOON SAMPLER
- B. 3" O.D. THIN WALL SAMPLER
- C. 3-1/4" O.D. x 2-1/2" LINER

- D. 3-1/2" O.D. SPLIT-BARREL SAMPLER
- E. 2" I.D. SPLIT-SPOON SAMPLER
- X. SAMPLE NOT RECOVERED

- A. - ATTERBERG
- G. - GRAIN SIZE
- C. - CONSOLIDATION

- DS - DIRECT SHEAR
- T - TRIAXIAL
- P - PERMEABILITY

- ▽ WATER LEVEL - ATD
- ▼ WATER LEVEL - AD

BOREHOLE LOG HANSON EMSA 063-7109.GPJ GLDR_OAK.GDT 2/11/09



Hanson Permanente Cement Quarry

Job No 063-7109
Engr D.S.F.
Date 2/11/09

Hanson Permanente Cement Quarry
Cupertino, CA
East Materials Storage Area

SUMMARY: BORING NO. EMSA-1

SHEET 2 OF 3

DATE DRILLED: 5/21/07 - 5/21/07

DRILLING METHOD: CME 75 / 6" Hollow Stem Auger / SPT-Automatic 140LB Hammer

SURFACE CONDITIONS: Sand AND gravel to 3" diameter, dry

COORDINATES: N 1,943,921.0 FT
E 610,028.0 FT

ELEVATION: 614.0 FT

DEPTH IN FEET	SAMPLE NO.	RECOVERY	BLOWS/6"	SAMPLE TYPE	LAB MOISTURE % OF DRY WEIGHT	LAB TEST	LITHOLOGY	DESCRIPTION	SYMBOL	MOISTURE	CONSISTENCY	DEPTH IN FEET
20												20
25			13 19 21	SPT				@25': Green/dark brown, highly weathered, to 0.5" diameter, loose			dense	25
30			10 50 >50	SPT				@30': No recovery	GS		very dense	30
35			>50 >50 >50	SPT							very dense	35
40			>50 >50 >50	SPT				@39': Very hard			very dense	40

Continued Next Page

- | | | | | |
|--------------------------------|-------------------------------------|--------------------|-------------------|---------------------|
| A. 2" O.D. SPLIT-SPOON SAMPLER | D. 3-1/2" O.D. SPLIT-BARREL SAMPLER | A. - ATTERBERG | DS - DIRECT SHEAR | ▽ WATER LEVEL - ATD |
| B. 3" O.D. THIN WALL SAMPLER | E. 2" I.D. SPLIT-SPOON SAMPLER | G. - GRAIN SIZE | T - TRIAXIAL | ▼ WATER LEVEL - AD |
| C. 3-1/4" O.D. x 2-1/2" LINER | X. SAMPLE NOT RECOVERED | C. - CONSOLIDATION | P - PERMEABILITY | |

BOREHOLE LOG HANSON EMSA 063-7109.GPJ GLDR_OAK.GDT 2/11/09



Hanson Permanente Cement Quarry

Job No 063-7109
Engr D.S.F.
Date 2/11/09

Hanson Permanente Cement Quarry
Cupertino, CA
East Materials Storage Area

SUMMARY: BORING NO. EMSA-1

SHEET 3 OF 3

DATE DRILLED: 5/21/07 - 5/21/07

COORDINATES: N 1,943,921.0 FT
E 610,028.0 FT

DRILLING METHOD: CME 75 / 6" Hollow Stem Auger / SPT-Automatic 140LB Hammer

SURFACE CONDITIONS: Sand AND gravel to 3" diameter, dry

ELEVATION: 614.0 FT

DEPTH IN FEET	SAMPLE NO.	RECOVERY	BLOWS/6"	SAMPLE TYPE	LAB MOISTURE % OF DRY WEIGHT	LAB TEST	LITHOLOGY	DESCRIPTION	SYMBOL	MOISTURE	CONSISTENCY	DEPTH IN FEET
40								Auger Refusal @ 40.5' BGS End of Boring @40.5' BGS No Water Encountered	GS			40
45												45
50												50
55												55
60												60

- | | | | | |
|--------------------------------|-------------------------------------|--------------------|-------------------|---------------------|
| A. 2" O.D. SPLIT-SPOON SAMPLER | D. 3-1/2" O.D. SPLIT-BARREL SAMPLER | A. - ATTERBERG | DS - DIRECT SHEAR | ▽ WATER LEVEL - ATD |
| B. 3" O.D. THIN WALL SAMPLER | E. 2" I.D. SPLIT-SPOON SAMPLER | G. - GRAIN SIZE | T - TRIAXIAL | ▼ WATER LEVEL - AD |
| C. 3-1/4" O.D. x 2-1/2" LINER | X. SAMPLE NOT RECOVERED | C. - CONSOLIDATION | P - PERMEABILITY | |

BOREHOLE LOG HANSON EMSA 063-7109.GPJ GLDR_OAK.GDT 2/11/09



Hanson Permanente Cement Quarry

Job No 063-7109
Engr D.S.F.
Date 2/11/09

Hanson Permanente Cement Quarry
Cupertino, CA
East Materials Storage Area

SUMMARY: BORING NO. EMSA-2

SHEET 1 OF 3

DATE DRILLED: 5/22/07 - 5/22/07

COORDINATES: N 1,943,814.0 FT
E 6,099,713.0 FT

DRILLING METHOD: CME 75 / 6" Hollow Stem Auger / SPT-Automatic 140LB Hammer

SURFACE CONDITIONS: Gravel to 3" diameter

ELEVATION: 640.0 FT

DEPTH IN FEET	SAMPLE NO.	RECOVERY	BLOWS/6"	SAMPLE TYPE	LAB MOISTURE % OF DRY WEIGHT	LAB TEST	LITHOLOGY	DESCRIPTION	SYMBOL	MOISTURE	CONSISTENCY	DEPTH IN FEET
0								CLAYEY SAND (SC) w/ little gravel, dark yellowish brown, gravel to 2" diameter, loose, dry				0
5	EMSA-2-5	2 4 2	2 4 2	SPT Shelby		A, G		@5.5': Increasing gravel size (limestone), medium to high plasticity fines	SC		loose	5
10								@9': Mottled, greenstone and limestone gravel to 2" diameter			dense	10
15	EMSA-2-15	4 8 10	3 6 27	SPT		A, G		GREENSTONE, yellowish brown, mottled, to 3" diameter, subrounded, highly weathered, hard, dry	GS		medium dense	15
20											medium dense	20

Continued Next Page

- A. 2" O.D. SPLIT-SPOON SAMPLER D. 3-1/2" O.D. SPLIT-BARREL SAMPLER A. - ATTERBERG DS - DIRECT SHEAR ▽ WATER LEVEL - ATD
- B. 3" O.D. THIN WALL SAMPLER E. 2" I.D. SPLIT-SPOON SAMPLER G. - GRAIN SIZE T - TRIAXIAL ▾ WATER LEVEL - AD
- C. 3-1/4" O.D. x 2-1/2" LINER X. SAMPLE NOT RECOVERED C. - CONSOLIDATION P - PERMEABILITY

BOREHOLE LOG HANSON EMSA 063-7109.GPJ GLDR_OAK.GDT 2/11/09



Hanson Permanente Cement Quarry

Job No	063-7109	Hanson Permanente Cement Quarry Cupertino, CA East Materials Storage Area
Engr	D.S.F.	
Date	2/11/09	

SUMMARY: BORING NO. EMSA-2

SHEET 2 OF 3

DATE DRILLED: 5/22/07 - 5/22/07

COORDINATES: N 1,943,814.0 FT
E 6,099,713.0 FT

DRILLING METHOD: CME 75 / 6" Hollow Stem Auger / SPT-Automatic 140LB Hammer

SURFACE CONDITIONS: Gravel to 3" diameter

ELEVATION: 640.0 FT

DEPTH IN FEET	SAMPLE NO.	RECOVERY	BLOWS/6"	SAMPLE TYPE	LAB MOISTURE % OF DRY WEIGHT	LAB TEST	LITHOLOGY	DESCRIPTION	SYMBOL	MOISTURE	CONSISTENCY	DEPTH IN FEET
20												20
25			3 8 15	SPT				@25': Very mottled, brown/green/orange/red, mostly dark brown, some fines, completely weathered, fine gravel			medium dense	25
30			10 14 30	SPT					GS		dense	30
35			6 23 39	SPT				@35': Medium to highly weathered			very dense	35
40			8 21 42	SPT							very dense	40

Continued Next Page

- A. 2" O.D. SPLIT-SPOON SAMPLER
- B. 3" O.D. THIN WALL SAMPLER
- C. 3-1/4" O.D. x 2-1/2" LINER

- D. 3-1/2" O.D. SPLIT-BARREL SAMPLER
- E. 2" I.D. SPLIT-SPOON SAMPLER
- X. SAMPLE NOT RECOVERED

- A. - ATTERBERG
- G. - GRAIN SIZE
- C. - CONSOLIDATION

- DS - DIRECT SHEAR
- T - TRIAXIAL
- P - PERMEABILITY

- ▽ WATER LEVEL - ATD
- ▼ WATER LEVEL - AD

BOREHOLE LOG HANSON EMSA 063-7109.GPJ GLDR_OAK.GDT 2/11/09



Hanson Permanente Cement Quarry

Job No 063-7109
Engr D.S.F.
Date 2/11/09

Hanson Permanente Cement Quarry
Cupertino, CA
East Materials Storage Area

SUMMARY: BORING NO. EMSA-2

SHEET 3 OF 3

DATE DRILLED: 5/22/07 - 5/22/07

COORDINATES: N 1,943,814.0 FT
E 6,099,713.0 FT

DRILLING METHOD: CME 75 / 6" Hollow Stem Auger / SPT-Automatic 140LB Hammer

SURFACE CONDITIONS: Gravel to 3" diameter

ELEVATION: 640.0 FT

DEPTH IN FEET	SAMPLE NO.	RECOVERY	BLOWS/6"	SAMPLE TYPE	LAB MOISTURE % OF DRY WEIGHT	LAB TEST	LITHOLOGY	DESCRIPTION	SYMBOL	MOISTURE	CONSISTENCY	DEPTH IN FEET
40												40
45			6 50 >50	SPT					GS		very dense	45
50								End of Borehole @ 45' BGS No Water Encountered				50
55												55
60												60

- A. 2" O.D. SPLIT-SPOON SAMPLER
- B. 3" O.D. THIN WALL SAMPLER
- C. 3-1/4" O.D. x 2-1/2" LINER

- D. 3-1/2" O.D. SPLIT-BARREL SAMPLER
- E. 2" I.D. SPLIT-SPOON SAMPLER
- X. SAMPLE NOT RECOVERED

- A. - ATTERBERG
- G. - GRAIN SIZE
- C. - CONSOLIDATION

- DS - DIRECT SHEAR
- T - TRIAXIAL
- P - PERMEABILITY

- ▽ WATER LEVEL - ATD
- ▼ WATER LEVEL - AD

BOREHOLE LOG HANSON EMSA 063-7109.GPJ GLDR_OAK.GDT 2/11/09



Hanson Permanente Cement Quarry

Job No 063-7109
Engr D.S.F.
Date 2/11/09

Hanson Permanente Cement Quarry
Cupertino, CA
East Materials Storage Area

SUMMARY: BORING NO. EMSA-3

SHEET 1 OF 2

DATE DRILLED: 5/23/07 - 5/23/07

COORDINATES: N 1,944,094.0 FT
E 6,099,499.0 FT

DRILLING METHOD: CME 75 / 6" Hollow Stem Auger / SPT-Automatic 140LB Hammer

SURFACE CONDITIONS: High grass

ELEVATION: 709.0 FT

DEPTH IN FEET	SAMPLE NO.	RECOVERY	BLOWS/6"	SAMPLE TYPE	LAB MOISTURE % OF DRY WEIGHT	LAB TEST	LITHOLOGY	DESCRIPTION	SYMBOL	MOISTURE	CONSISTENCY	DEPTH IN FEET
0												0
5	EMSA-3-5	8 15 17	SPT	G			SANDSTONE (Santa Clara Fm), yellowish brown, red, mottled, some gravel to 1", fine grained, poorly sorted, subrounded, highly weathered, dry			dry	dense	5
10		11 24 30	SPT				@9': Trace fines, gravel, to 1.5" diameter, some quartz veins	SS			very dense	10
15		15 50 >50	SPT				@14': Greywacke, quartz				very dense	15
20		11 17 30	SPT				@19': Large pieces of quartz				dense	20

Continued Next Page

- | | | | | |
|--------------------------------|-------------------------------------|--------------------|-------------------|---------------------|
| A. 2" O.D. SPLIT-SPOON SAMPLER | D. 3-1/2" O.D. SPLIT-BARREL SAMPLER | A. - ATTERBERG | DS - DIRECT SHEAR | ▽ WATER LEVEL - ATD |
| B. 3" O.D. THIN WALL SAMPLER | E. 2" I.D. SPLIT-SPOON SAMPLER | G. - GRAIN SIZE | T - TRIAXIAL | ▼ WATER LEVEL - AD |
| C. 3-1/4" O.D. x 2-1/2" LINER | X. SAMPLE NOT RECOVERED | C. - CONSOLIDATION | P - PERMEABILITY | |

BOREHOLE LOG HANSON EMSA 063-7109.GPJ GLDR_OAK.GDT 2/11/09



Hanson Permanente Cement Quarry

Job No 063-7109
Engr D.S.F.
Date 2/11/09

Hanson Permanente Cement Quarry
Cupertino, CA
East Materials Storage Area

SUMMARY: BORING NO. EMSA-3

SHEET 2 OF 2

DATE DRILLED: 5/23/07 - 5/23/07

COORDINATES: N 1,944,094.0 FT
E 6,099,499.0 FT

DRILLING METHOD: CME 75 / 6" Hollow Stem Auger / SPT-Automatic 140LB Hammer

SURFACE CONDITIONS: High grass

ELEVATION: 709.0 FT

20 DEPTH IN FEET	SAMPLE NO.	RECOVERY	BLOWS/6"	SAMPLE TYPE	LAB MOISTURE % OF DRY WEIGHT	LAB TEST	LITHOLOGY	DESCRIPTION	SYMBOL	MOISTURE	CONSISTENCY	20 DEPTH IN FEET
20							•••••					20
25		16	50	SPT			•••••	@24': Dark yellowish brown, little fines, more cemented, damp	SS	moist	very dense	25
30		50	>50	SPT			•••••	@30': Gravel to 2" diameter, very hard			very dense	30
35							•••••	Auger Refusal @ 32' BGS End of Borehole @ 32' BGS No Water Encountered				35
40							•••••					40

- | | | | | |
|--------------------------------|-------------------------------------|--------------------|-------------------|---------------------|
| A. 2" O.D. SPLIT-SPOON SAMPLER | D. 3-1/2" O.D. SPLIT-BARREL SAMPLER | A. - ATTERBERG | DS - DIRECT SHEAR | ▽ WATER LEVEL - ATD |
| B. 3" O.D. THIN WALL SAMPLER | E. 2" I.D. SPLIT-SPOON SAMPLER | G. - GRAIN SIZE | T - TRIAXIAL | ▼ WATER LEVEL - AD |
| C. 3-1/4" O.D. x 2-1/2" LINER | X. SAMPLE NOT RECOVERED | C. - CONSOLIDATION | P - PERMEABILITY | |

BOREHOLE LOG HANSON EMSA 063-7109.GPJ GLDR_OAK.GDT 2/11/09



Hanson Permanente Cement Quarry

Job No 063-7109
Engr D.S.F.
Date 2/11/09

Hanson Permanente Cement Quarry
Cupertino, CA
East Materials Storage Area

SUMMARY: BORING NO. EMSA-4

SHEET 1 OF 2

DATE DRILLED: 5/22/07 - 5/22/07

COORDINATES: N 1,943,135.0 FT
E 6,098,783.0 FT

DRILLING METHOD: CME 75 / 6" Hollow Stem Auger / SPT-Automatic 140LB Hammer

SURFACE CONDITIONS: Gravel to 2" diameter

ELEVATION: 746.0 FT

DEPTH IN FEET	SAMPLE NO.	RECOVERY	BLOWS/6"	SAMPLE TYPE	LAB MOISTURE % OF DRY WEIGHT	LAB TEST	LITHOLOGY	DESCRIPTION	SYMBOL	MOISTURE	CONSISTENCY	DEPTH IN FEET
0								SANDSTONE (Shear Zone), w/ some greywacke, gravel to 2" diameter, yellowish brown, red, mottled, fine grained, subrounded to subangular, highly weathered, dry				0
5	EMSA-4-5	10 11 12	SPT			G				dry	medium dense	5
	EMSA-4-(5.5-			Shelby		G		@ 5.5': Cobbles to 4" diameter				
10		6 8 13	SPT						SS		medium dense	10
15		6 7 12	SPT					@14': Increasing greywacke to 3" diameter, green, brown, fine grained, subangular, highly weathered, dry			medium dense	15
20		7 10 13	SPT					@19': Mottled, red, yellow, brown, completely weathered			medium dense	20

Continued Next Page

- A. 2" O.D. SPLIT-SPOON SAMPLER
- B. 3" O.D. THIN WALL SAMPLER
- C. 3-1/4" O.D. x 2-1/2" LINER

- D. 3-1/2" O.D. SPLIT-BARREL SAMPLER
- E. 2" I.D. SPLIT-SPOON SAMPLER
- X. SAMPLE NOT RECOVERED

- A. - ATTERBERG
- G. - GRAIN SIZE
- C. - CONSOLIDATION

- DS - DIRECT SHEAR
- T - TRIAXIAL
- P - PERMEABILITY

- ▽ WATER LEVEL - ATD
- ▼ WATER LEVEL - AD

BOREHOLE LOG HANSON EMSA 063-7109.GPJ GLDR_OAK.GDT 2/11/09



Hanson Permanente Cement Quarry

Job No 063-7109
Engr D.S.F.
Date 2/11/09

Hanson Permanente Cement Quarry
Cupertino, CA
East Materials Storage Area

SUMMARY: BORING NO. EMSA-4

SHEET 2 OF 2

DATE DRILLED: 5/22/07 - 5/22/07

COORDINATES: N 1,943,135.0 FT
E 6,098,783.0 FT

DRILLING METHOD: CME 75 / 6" Hollow Stem Auger / SPT-Automatic 140LB Hammer

SURFACE CONDITIONS: Gravel to 2" diameter

ELEVATION: 746.0 FT

20 DEPTH IN FEET	SAMPLE NO.	RECOVERY	BLOWS/6"	SAMPLE TYPE	LAB MOISTURE % OF DRY WEIGHT	LAB TEST	LITHOLOGY	DESCRIPTION	SYMBOL	MOISTURE	CONSISTENCY	20 DEPTH IN FEET
20							[Dotted Pattern]		SS	moist	medium dense	20
25			5 6 8	SPT			[Dotted Pattern]	SILTY SAND (SM) w/ little gravel to 0.5", very dark brown, soft, moist, slight sheen, slight odor	SM			25
30			7 14 18	SPT			[Dotted Pattern]	SANDSTONE (Shear Zone), w/ some greywacke, gravel to 2" diameter, yellowish brown, red, mottled, fine grained, subrounded to subangular, highly weathered, dry		dry	dense	30
35			13 50 >50	SPT			[Dotted Pattern]		SS		very dense	35
40								Auger Refusal @ 38' BGS End of Borehole @ 38' BGS No Water Encountered				40

- | | | | | |
|--------------------------------|-------------------------------------|--------------------|-------------------|---------------------|
| A. 2" O.D. SPLIT-SPOON SAMPLER | D. 3-1/2" O.D. SPLIT-BARREL SAMPLER | A. - ATTERBERG | DS - DIRECT SHEAR | ▽ WATER LEVEL - ATD |
| B. 3" O.D. THIN WALL SAMPLER | E. 2" I.D. SPLIT-SPOON SAMPLER | G. - GRAIN SIZE | T - TRIAXIAL | ▼ WATER LEVEL - AD |
| C. 3-1/4" O.D. x 2-1/2" LINER | X. SAMPLE NOT RECOVERED | C. - CONSOLIDATION | P - PERMEABILITY | |

BOREHOLE LOG HANSON EMSA 063-7109.GPJ GLDR_OAK.GDT 2/11/09



Hanson Permanente Cement Quarry

Job No	063-7109	Hanson Permanente Cement Quarry	
Engr	D.S.F.	Cupertino, CA	
Date	2/11/09	East Materials Storage Area	

SUMMARY: BORING NO. EMSA-5

SHEET 1 OF 2

DATE DRILLED: 5/22/07 - 5/22/07

COORDINATES: N 1,943,360.0 FT
E 6,098,978.0 FT

DRILLING METHOD: CME 75 / 6" Hollow Stem Auger / SPT-Automatic 140LB Hammer

SURFACE CONDITIONS: Grass, sand, gravel to 3"

ELEVATION: 792.0 FT

DEPTH IN FEET	SAMPLE NO.	RECOVERY	BLOWS/6"	SAMPLE TYPE	LAB MOISTURE % OF DRY WEIGHT	LAB TEST	LITHOLOGY	DESCRIPTION	SYMBOL	MOISTURE	CONSISTENCY	DEPTH IN FEET
0												0
5	EMSA-5-5	22	50	SPT	>50	G		SANDSTONE (Santa Clara Fm), yellowish brown, red, mottled, greywacke, to 0.5" diameter, fine grained, subrounded, unconsolidated, highly weathered, dry		dry	very dense	5
10	EMSA-5-10	50	>50	SPT	>50	G			SS		very dense	10
15		50	>50	SPT	>50						very dense	15
20		20	50	SPT	>50						very dense	20

Continued Next Page

- | | | | | |
|--------------------------------|-------------------------------------|--------------------|-------------------|---------------------|
| A. 2" O.D. SPLIT-SPOON SAMPLER | D. 3-1/2" O.D. SPLIT-BARREL SAMPLER | A. - ATTERBERG | DS - DIRECT SHEAR | ▽ WATER LEVEL - ATD |
| B. 3" O.D. THIN WALL SAMPLER | E. 2" I.D. SPLIT-SPOON SAMPLER | G. - GRAIN SIZE | T - TRIAXIAL | ▼ WATER LEVEL - AD |
| C. 3-1/4" O.D. x 2-1/2" LINER | X. SAMPLE NOT RECOVERED | C. - CONSOLIDATION | P - PERMEABILITY | |

BOREHOLE LOG HANSON EMSA 063-7109.GPJ GLDR_OAK.GDT 2/11/09



Hanson Permanente Cement Quarry

Job No	063-7109	Hanson Permanente Cement Quarry Cupertino, CA East Materials Storage Area
Engr	D.S.F.	
Date	2/11/09	

SUMMARY: BORING NO. EMSA-5

SHEET 2 OF 2

DATE DRILLED: 5/22/07 - 5/22/07

COORDINATES: N 1,943,360.0 FT
E 6,098,978.0 FT

DRILLING METHOD: CME 75 / 6" Hollow Stem Auger / SPT-Automatic 140LB Hammer

SURFACE CONDITIONS: Grass, sand, gravel to 3"

ELEVATION: 792.0 FT

DEPTH IN FEET	SAMPLE NO.	RECOVERY	BLOWS/6"	SAMPLE TYPE	LAB MOISTURE % OF DRY WEIGHT	LAB TEST	LITHOLOGY	DESCRIPTION	SYMBOL	MOISTURE	CONSISTENCY	DEPTH IN FEET
20								@20': Gravel to 1.5" diameter, more consolidated				20
25			32 50 >50	SPT				@25': Calcite veins in rock fragments, subangular	SS		very dense	25
30			26 50 >50	SPT							very dense	30
35								Auger Refusal @ 32' BGS End of Borehole @ 32' BGS No Water Encountered				35
40												40

- | | | | | |
|--------------------------------|-------------------------------------|--------------------|-------------------|---------------------|
| A. 2" O.D. SPLIT-SPOON SAMPLER | D. 3-1/2" O.D. SPLIT-BARREL SAMPLER | A. - ATTERBERG | DS - DIRECT SHEAR | ▽ WATER LEVEL - ATD |
| B. 3" O.D. THIN WALL SAMPLER | E. 2" I.D. SPLIT-SPOON SAMPLER | G. - GRAIN SIZE | T - TRIAXIAL | ▼ WATER LEVEL - AD |
| C. 3-1/4" O.D. x 2-1/2" LINER | X. SAMPLE NOT RECOVERED | C. - CONSOLIDATION | P - PERMEABILITY | |

BOREHOLE LOG HANSON EMSA 063-7109.GPJ GLDR_OAK.GDT 2/11/09



Hanson Permanente Cement Quarry

Job No	063-7109	Hanson Permanente Cement Quarry Cupertino, CA East Materials Storage Area
Engr	D.S.F.	
Date	2/11/09	

APPENDIX B

SUMMARY OF LABORATORY TEST RESULTS

APPENDIX B-1

FOUNDATION SOILS



#200 Sieve Wash Analysis ASTM D 1140

Job No.: <u>287-031a</u>	Project No.: <u>063-7109.011</u>	Run By: <u>MD</u>
Client: <u>Golder Associates</u>	Date: <u>6/21/2007</u>	Checked By: <u>DC</u>
Project: <u>Hanson/East Materials Storage Area</u>		

	EMSA-1	EMSA-1	EMSA-1	EMSA-2	EMSA-2	EMSA-3	EMSA-4	EMSA-5
Boring:	1	3	5	1	4	1	1	1
Sample:	1	3	5	1	4	1	1	1
Depth, ft.:	5	10	20	5	15	5	5	5
Soil Type:	Brown Clayey SAND w/ Gravel	Marbled Blue & Greenish Brown Lean Clayey SAND w/ Gravel	Mottled Gray & Black Sandy Lean CLAY	Brown Lean Clayey SAND	Mottled Brown & Gray Lean Clayey SAND	Light Brownish Yellow Sandy CLAY	Brown Clayey SAND w/ Gravel	Light Bown Clayey SAND
Wt of Dish & Dry Soil, gm	290.8	452.4	657.4	426.9	384.1	564.9	810.3	370.9
Weight of Dish, gm	83.5	77.9	80.4	84.4	84.5	79.8	84.5	81.1
Weight of Dry Soil, gm	207.3	374.5	577.0	342.5	299.6	485.1	725.8	289.8
Wt. Ret. on #4 Sieve, gm	42.5	89.0	79.2	48.7	34.4	25.2	227.5	27.7
Wt. Ret. on #200 Sieve, gm	166.9	225.2	271.2	200.8	161.4	205.4	535.7	168.4
% Gravel	20.5	23.8	13.7	14.2	11.5	5.2	31.3	9.6
% Sand	60.0	36.4	33.3	44.4	42.4	37.1	42.5	48.6
% Silt & Clay	19.5	39.9	53.0	41.4	46.1	57.7	26.2	41.9

Remarks: As an added benefit to our clients, the gravel fraction may be included in this report. Whether or not it is included is dependent upon both the technician's time available and if there is a significant enough amount of gravel. The gravel is always included in the percent retained on the #200 sieve but may not be weighed separately to determine the percentage, especially if there is only a trace amount, (5% or less).



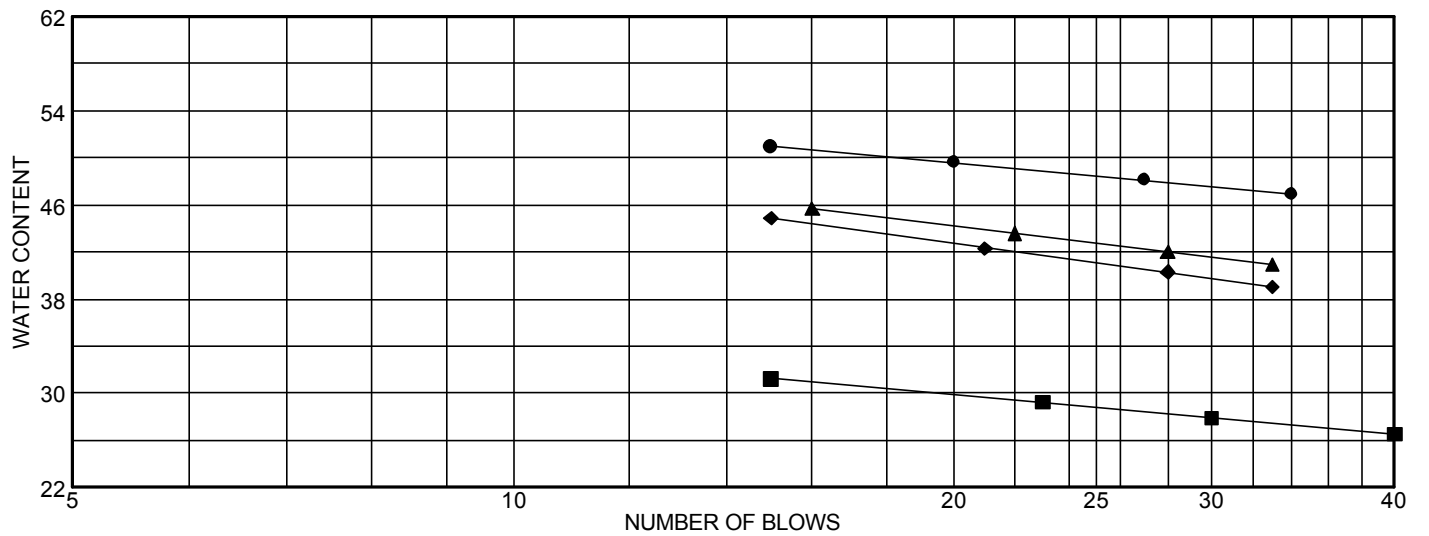
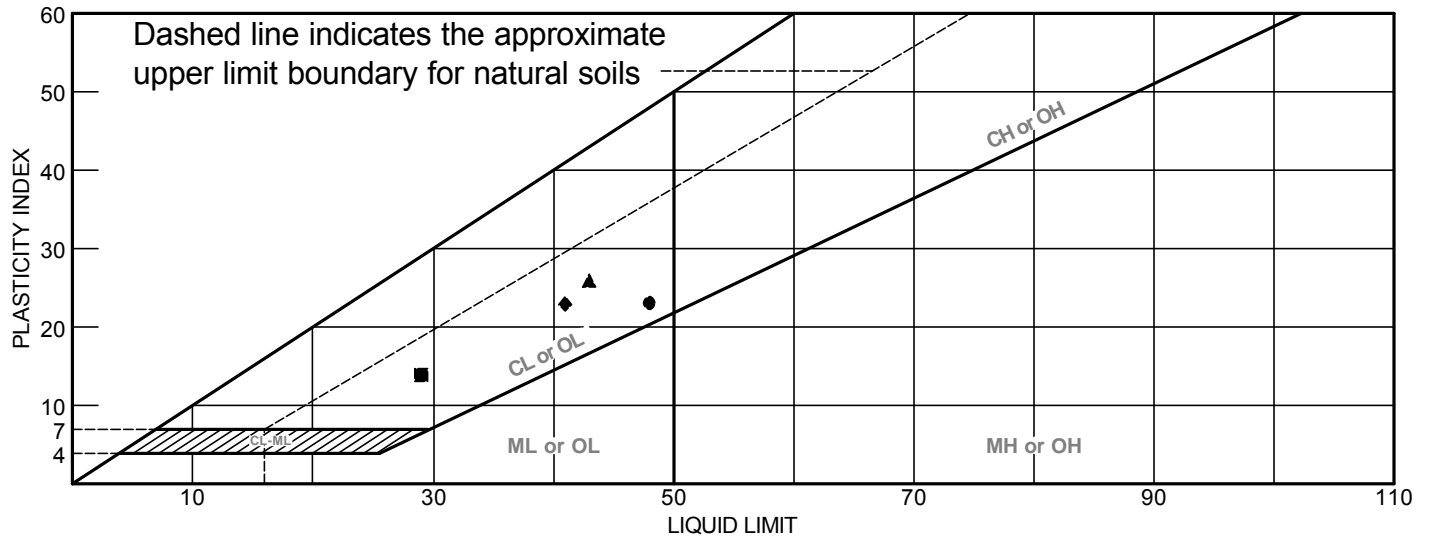
#200 Sieve Wash Analysis ASTM D 1140

Job No.: <u>287-031b</u>	Project No.: <u>063-7109.011</u>	Run By: <u>MD</u>
Client: <u>Golder Associates</u>	Date: <u>6/21/2007</u>	Checked By: <u>DC</u>
Project: <u>Hanson/East Materials Storage Area</u>		

	EMSA-5	EMSA-1	EMSA-4				
Boring:	EMSA-5	EMSA-1	EMSA-4				
Sample:	2						
Depth, ft.:	10	5-7	5.5-8				
Soil Type:	Light Brown Clayey SAND	Gray Sandy CLAY w/ Gravel	Light Yellowish Brown Clayey SAND w/ Gravel				
Wt of Dish & Dry Soil, gm	631.0	611.3	784.5				
Weight of Dish, gm	100.2	174.3	329.5				
Weight of Dry Soil, gm	530.8	437.1	455.0				
Wt. Ret. on #4 Sieve, gm	53.7	66.2	95.7				
Wt. Ret. on #200 Sieve, gm	318.1	188.2	314.1				
% Gravel	10.1	15.1	21.0				
% Sand	49.8	27.9	48.0				
% Silt & Clay	40.1	56.9	31.0				

Remarks: As an added benefit to our clients, the gravel fraction may be included in this report. Whether or not it is included is dependent upon both the technician's time available and if there is a significant enough amount of gravel. The gravel is always included in the percent retained on the #200 sieve but may not be weighed separately to determine the percentage, especially if there is only a trace amount, (5% or less).

LIQUID AND PLASTIC LIMITS TEST REPORT



	MATERIAL DESCRIPTION	LL	PL	PI	%<#40	%<#200	USCS
●	Brown Lean Clayey SAND	48	25	23			
■	Mottled Brown & Gray Lean Clayey SAND	29	15	14			
▲	Marbled Blue & Greenish Brown Lean Clayey SAND w/ Gravel	43	17	26			
◆	Mottled Gray & Black Sandy Lean CLAY	41	18	23			

Project No. 287-031 **Client:** Golder Associates
Project: Hanson/East Materials Storage Area - 063-7109.011

● Source: EMSA-2	● Sample No.: 1	● Elev./Depth: 5'
■ Source: EMSA-2	■ Sample No.: 4	■ Elev./Depth: 15'
▲ Source: EMSA-1	▲ Sample No.: 3	▲ Elev./Depth: 10'
◆ Source: EMSA-1	◆ Sample No.: 5	◆ Elev./Depth: 20'

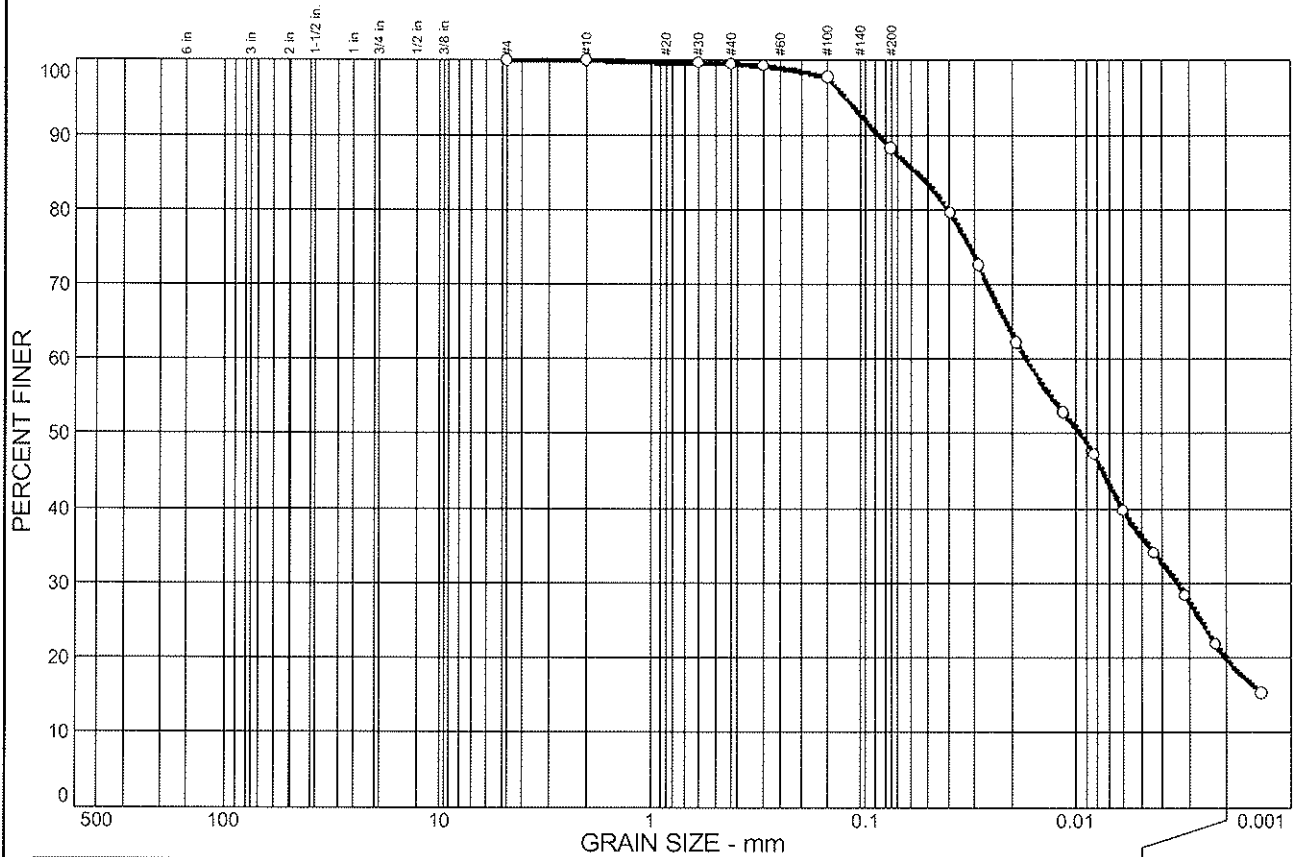
Remarks:

-
-
- ▲
- ◆

APPENDIX B-2

FINE WASTE

PARTICLE SIZE DISTRIBUTION TEST REPORT



% + 3"	% GRAVEL		% SAND			% FINES	
	CRS.	FINE	CRS.	MEDIUM	FINE	SILT	CLAY
0.0	0.0	0.0	0.0	0.5	11.3	68.3	19.9

SIEVE SIZE	PERCENT FINER	SPEC.* PERCENT	PASS? (X=NO)
#4	100.0		
#10	100.0		
#30	99.6		
#40	99.5		
#50	99.2		
#100	97.7		
#200	88.2		
0.0393 mm.	79.5		
0.0288 mm.	72.5		
0.0191 mm.	62.2		
0.015 mm.	52.8		
0.0083 mm.	47.2		
0.0060 mm.	39.7		
0.0043 mm.	34.1		
0.0031 mm.	28.4		
0.0023 mm.	21.9		
0.0014 mm.	15.3		

Soil Description

Gray Silty CLAY

Atterberg Limits

PL= 19 LL= 24 PI= 5

Coefficients

D₈₅= 0.0570 D₆₀= 0.0172 D₅₀= 0.0096
D₃₀= 0.0034 D₁₅= D₁₀=
C_u= C_c=

Classification

USCS= CL-ML AASHTO=

Remarks

* (no specification provided)

Sample No.:
Location:

Source of Sample: (In House 3/5/08)

Date:
Elev./Depth:

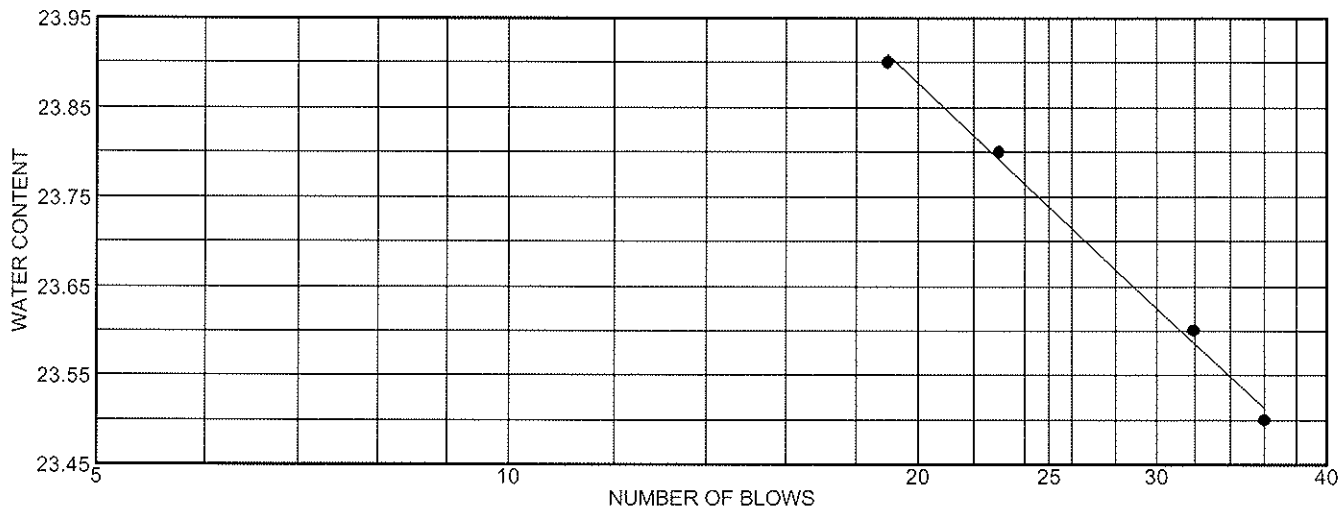
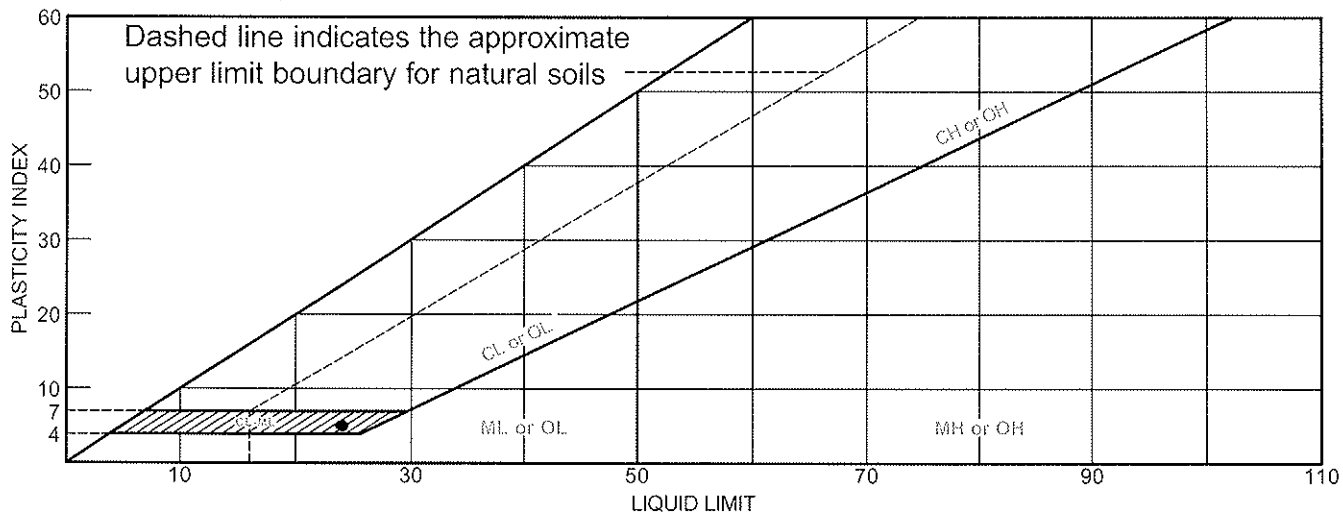
COOPER TESTING LABORATORY

Client: Golder & Associates
Project: Hanson - 0637109-100-103

Project No: 287-035

Figure

LIQUID AND PLASTIC LIMITS TEST REPORT



	MATERIAL DESCRIPTION	LL	PL	PI	%<#40	%<#200	USCS
●	Gray Silty CLAY	24	19	5	99.5	88.2	CL-ML

Project No. 287-035 **Client:** Golder & Associates

Project: Hanson - 0637109-100-103

● **Source:** (In House 3/5/08)

Remarks:

●

LIQUID AND PLASTIC LIMITS TEST REPORT

COOPER TESTING LABORATORY

Figure



Moisture-Density-Porosity Report

Cooper Testing Labs, Inc.

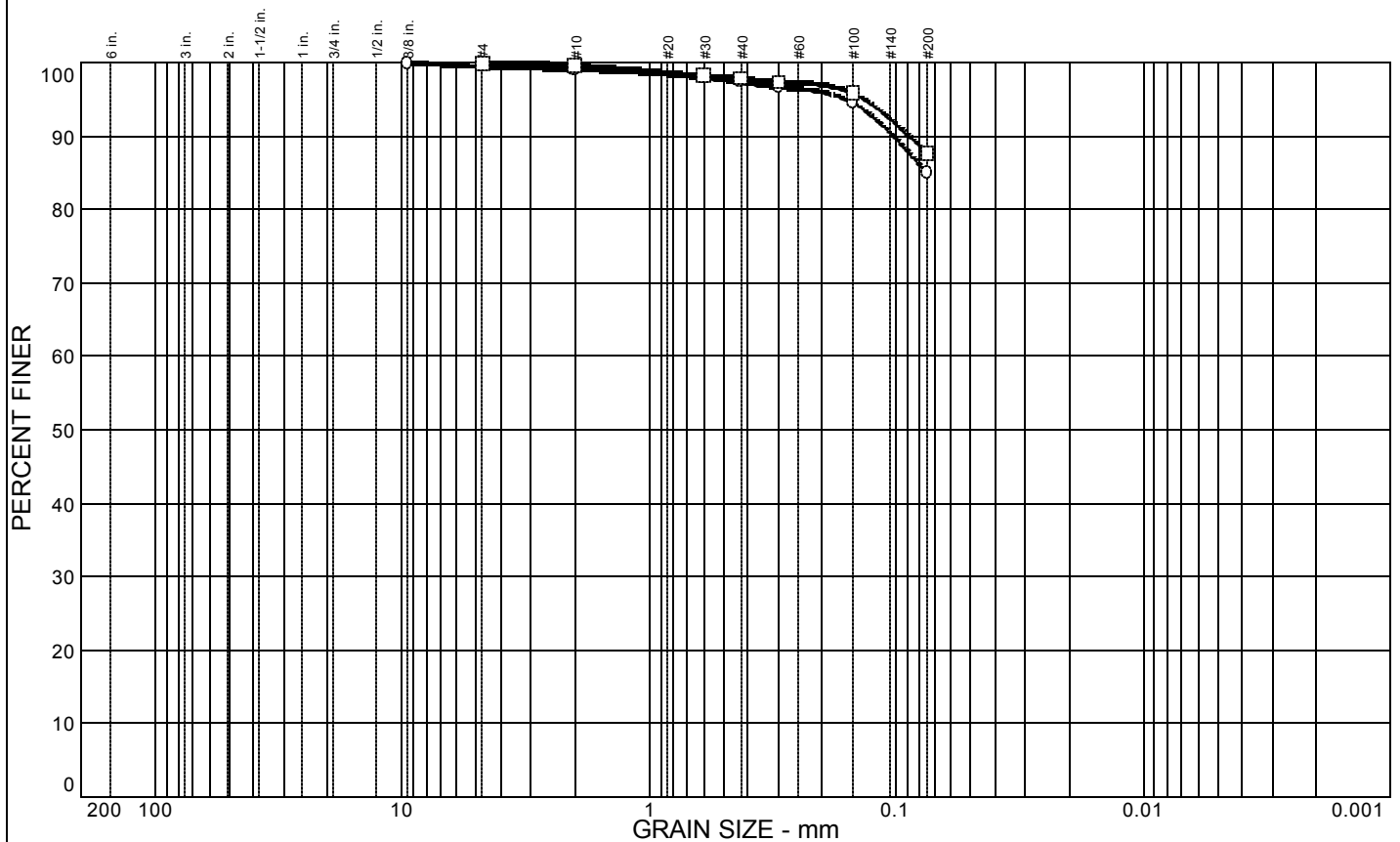
Job No:	<u>287-035</u>	Date:	<u>03/07/08</u>
Client:	<u>Golder Associates</u>	By:	<u>RU</u>
Project:	<u>Hanson - 0637109-100-103</u>	Remarks:	

Boring:	(In House 3/5/08)						
Sample: Depth, ft:							
Visual Description:	Gray Silty CLAY						
Actual G_s							
Assumed G_s	2.70						
Total Vol cc	250.3						
Vol Solids,cc	99.7						
Vol Voids,cc	150.6						
Moisture, %	53.8						
Wet Unit wt, pcf	103.3						
Dry Unit wt, pcf	67.2						
Saturation, %	96.2						
Porosity, %	60.2						
Air filled Poros.,%	2.3						
Water filled Poros.,%	57.9						
Void Ratio	1.51						
Series	1	2	3	4	5	6	7

Note: If an assumed specific gravity (G_s) was used then the saturation, porosities, and void ratio should be considered approximate.



Particle Size Distribution Report



	% COBBLES	% GRAVEL	% SAND	% SILT	% CLAY	USCS	AASHTO	PL	LL
○		0.5	14.4	85.1		CL		18	30
□			12.3	87.7		CL		18	32

SIEVE inches size	PERCENT FINER	
	○	□
3/8	100.0	
GRAIN SIZE		
D ₆₀		
D ₃₀		
D ₁₀		
COEFFICIENTS		
C _c		
C _u		

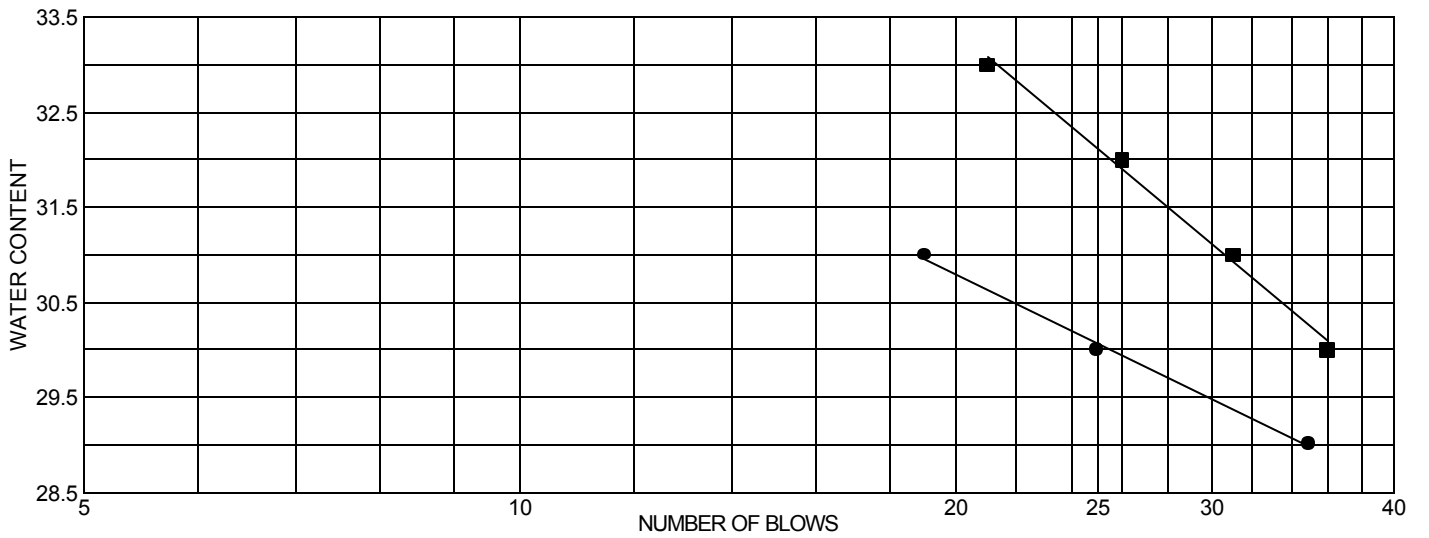
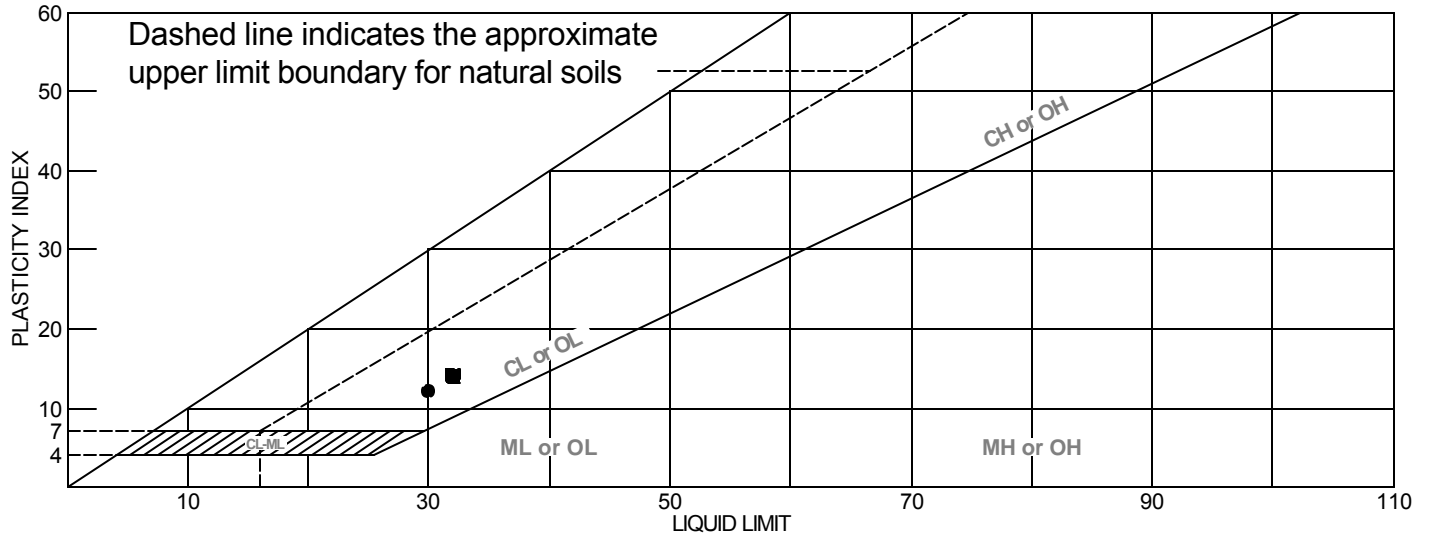
SIEVE number size	PERCENT FINER	
	○	□
#4	99.5	100.0
#10	99.1	99.7
#30	98.0	98.3
#40	97.4	97.9
#50	96.7	97.4
#100	94.6	95.9
#200	85.1	87.7

SOIL DESCRIPTION
 ○ Gray Lean CLAY
 □ Gray Lean CLAY

REMARKS:
 ○
 □

○ Source: FW-1 1/3
 □ Source: FW-2 1/3

LIQUID AND PLASTIC LIMITS TEST REPORT



	MATERIAL DESCRIPTION	LL	PL	PI	%<#40	%<#200	USCS
●	Gray Lean CLAY	30	18	12	97.4	85.1	CL
■	Gray Lean CLAY	32	18	14	97.9	87.7	CL

Project No. 287-037 **Client:** Golder Associates
Project: Hanson Dump Review - 063.730
Source: FW-1 1/3
Source: FW-2 1/3

Remarks:
 ●
 ■



Moisture-Density-Porosity Report

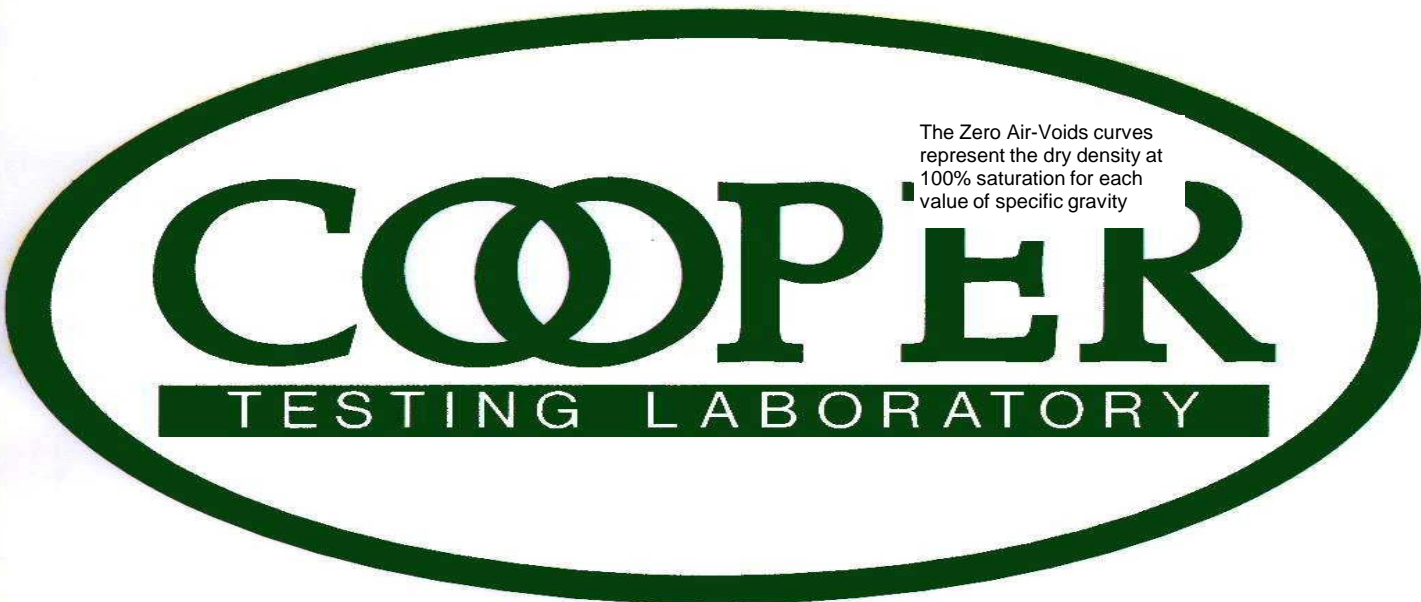
Cooper Testing Labs, Inc.

Job No: <u>287-037</u>	Date: <u>06/24/08</u>
Client: <u>Golder Associates</u>	By: <u>RU</u>
Project: <u>Hanson Dump Review - 063.730</u>	Remarks: <u>FW-2;2/3 - sample disturbed; m/c only.</u>

Boring:	FW-1	FW-2	FW-2					
Sample:	1/3	1/3	2/3					
Depth, ft:	0	0	0					
Visual Description:	Gray Lean CLAY	Gray Lean CLAY	Gray Lean CLAY					

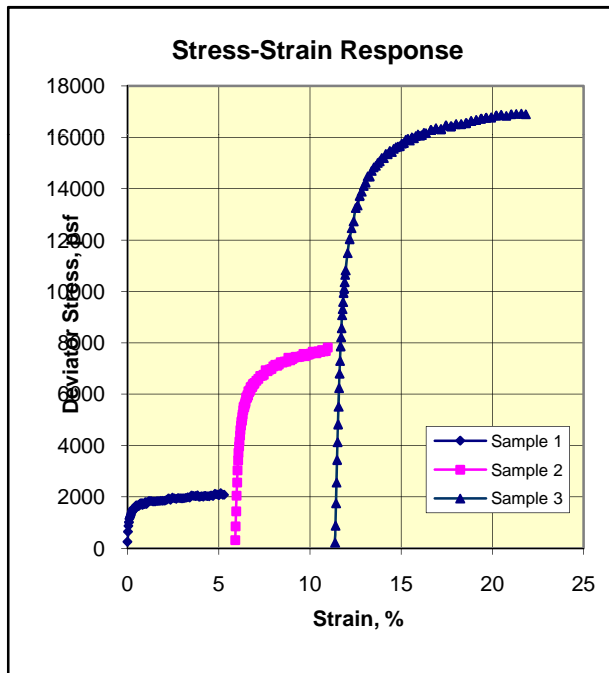
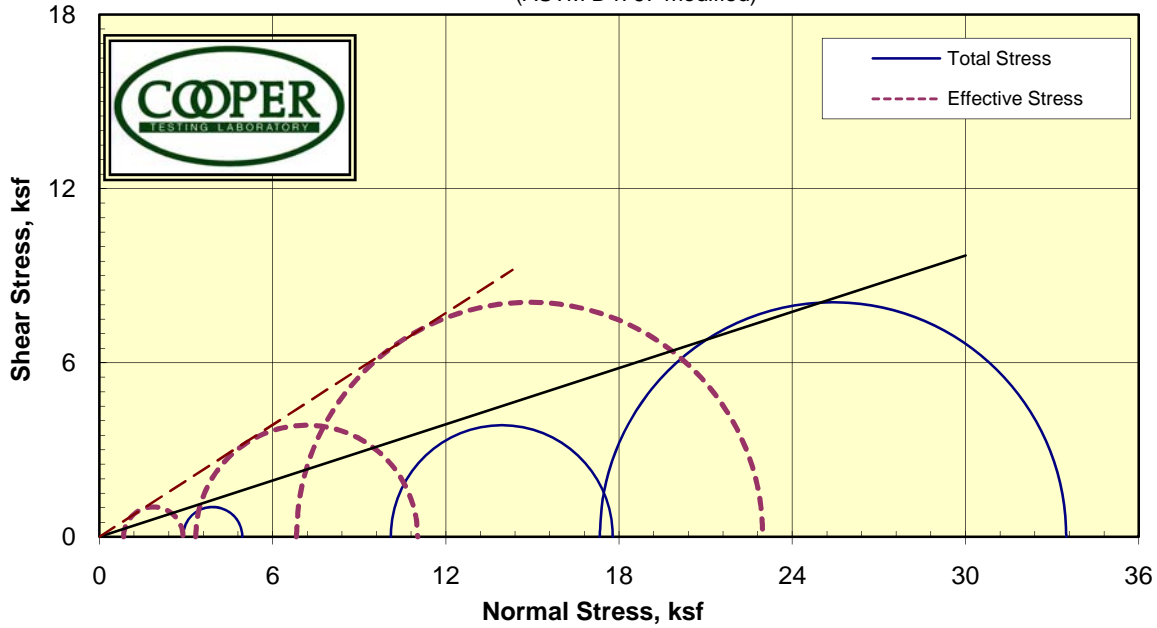
Actual G_s								
Assumed G_s	2.70	2.70	2.70					
Total Vol cc	147.1	150.9	374.1					
Vol Solids,cc	72.0	62.1	180.7					
Vol Voids,cc	75.1	88.7	193.3					
Moisture, %	38.5	50.7	30.6					
Wet Unit wt, pcf	114.4	104.7	106.4					
Dry Unit wt, pcf	82.6	69.5	81.5					
Saturation, %	99.7	95.8	77.2					
Porosity, %	51.0	58.8	51.7					
Air filled Poros.,%	0.1	2.5	11.8					
Water filled Poros.,%	50.9	56.4	39.9					
Void Ratio	1.04	1.43	1.07					
Series	1	2	3	4	5	6	7	8

Note: If an assumed specific gravity (Gs) was used then the saturation, porosities, and void ratio should be considered approximate.



Triaxial Consolidated Undrained

(ASTM D4767 modified)

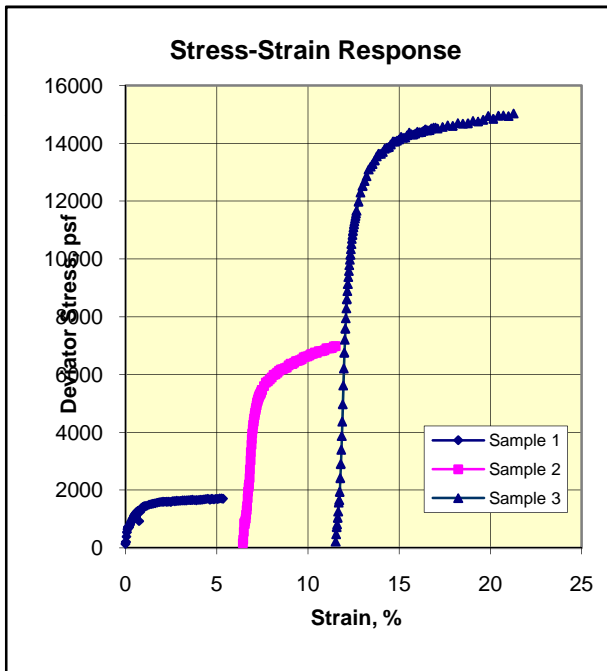
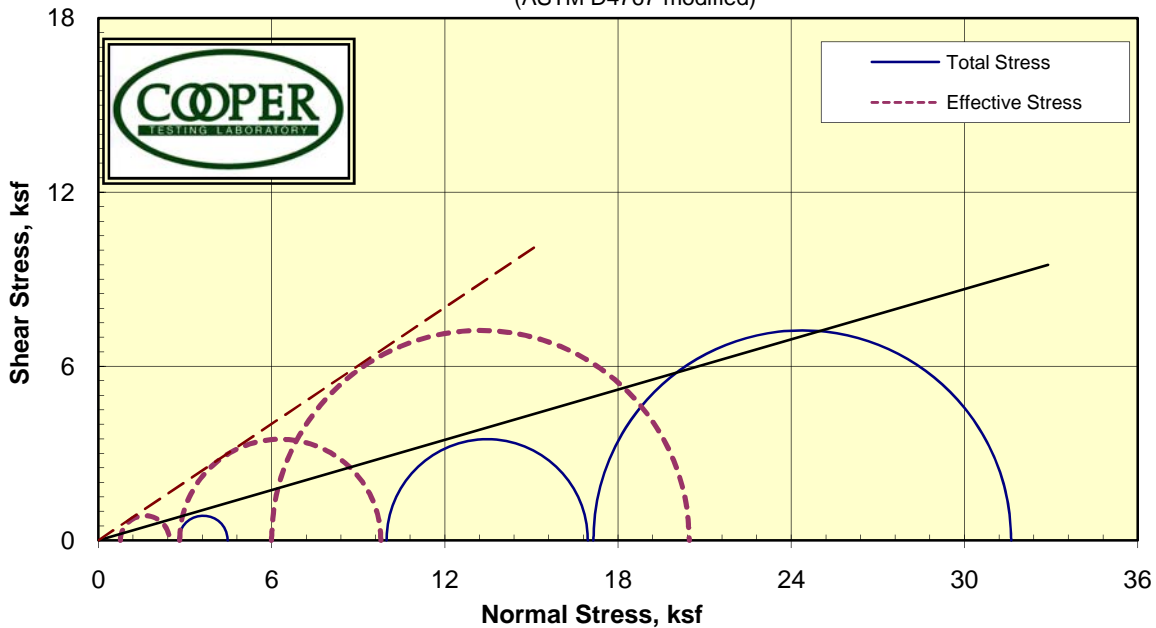


Stage	1	2	3
MC, %	36.8		
Dry Dens., pcf.	82.5		
Sat. %	95.4		
Void Ratio	1.042		
Diameter in	2.41		
Height, in	5.00		
	Final		
MC, %	21.9	18.6	17.3
Dry Dens., pcf.	91.5	96.1	98.1
Sat. %	100.0	100.0	100.0
Void Ratio	0.590	0.502	0.467
Diameter, in	2.35	2.30	2.33
Height, in	4.73	4.72	4.49
Cell, psi	70.0	120.0	170.0
BP, psi	49.9	49.9	49.7
	Effective Stresses At:		
Strain, %	5.0	5.0	5.0
Deviator ksf	2.058	7.691	16.165
Excess PP	2.052	6.758	10.504
Sigma 1	2.899	11.026	22.989
Sigma 3	0.842	3.335	6.823
P, ksf	1.870	7.180	14.906
Q, ksf	1.029	3.845	8.083
Stress Ratio	3.445	3.306	3.369
Rate in/min	0.001	0.001	0.001
Total C	0	Effective C	0.0
Total Phi	17.9	Effective Phi	32.7

Job No.: 287-037 **Date:** 6/18/2008
Client: Golder Associates BY:DC
Project: Hanson Dump Review - 063.730
Sample: FW-1;2/3 Gray Lean CLAY
Remarks: ** Staged Test ** Strengths at 5% strain.

Triaxial Consolidated Undrained

(ASTM D4767 modified)



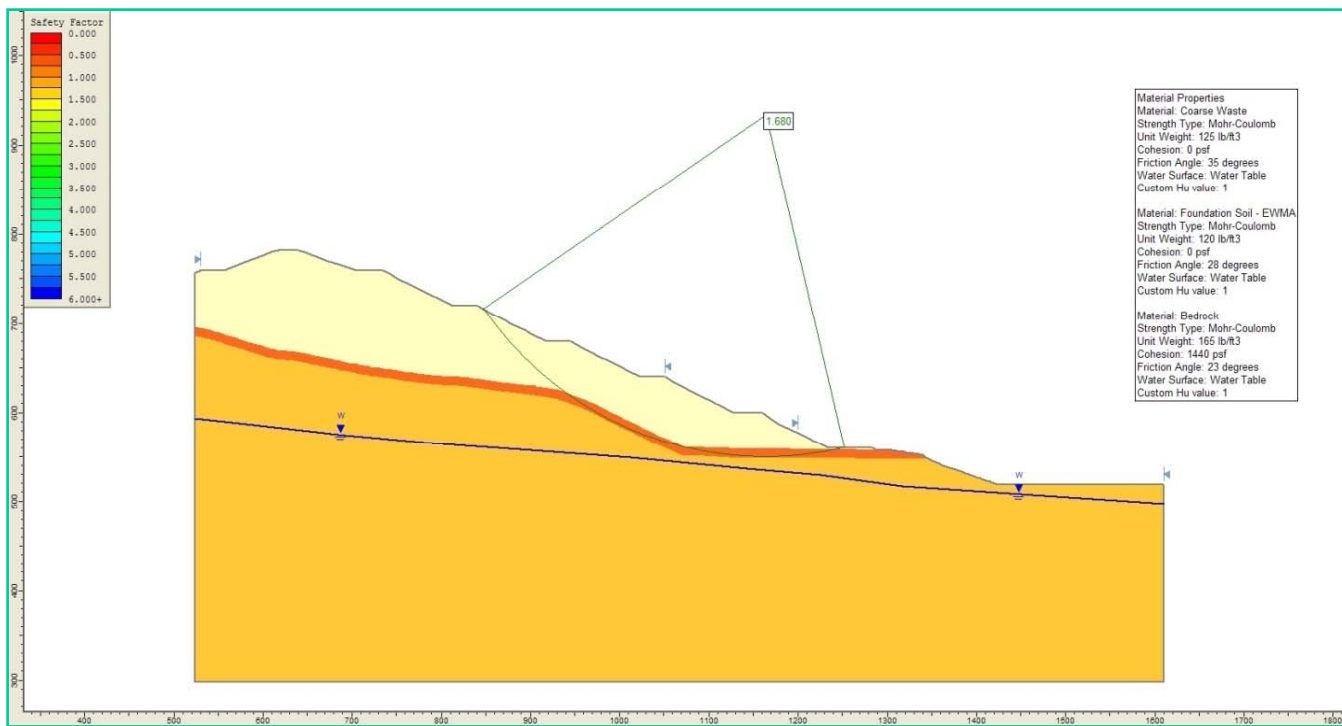
Job No.: 287-037 Date: 6/24/2008
 Client: Golder Associates BY: DC
 Project: Hanson Dump Review - 063.730
 Sample: FW-2;3/3 Gray Lean CLAY

Remarks: ** Staged Test ** Strengths at 5% strain.

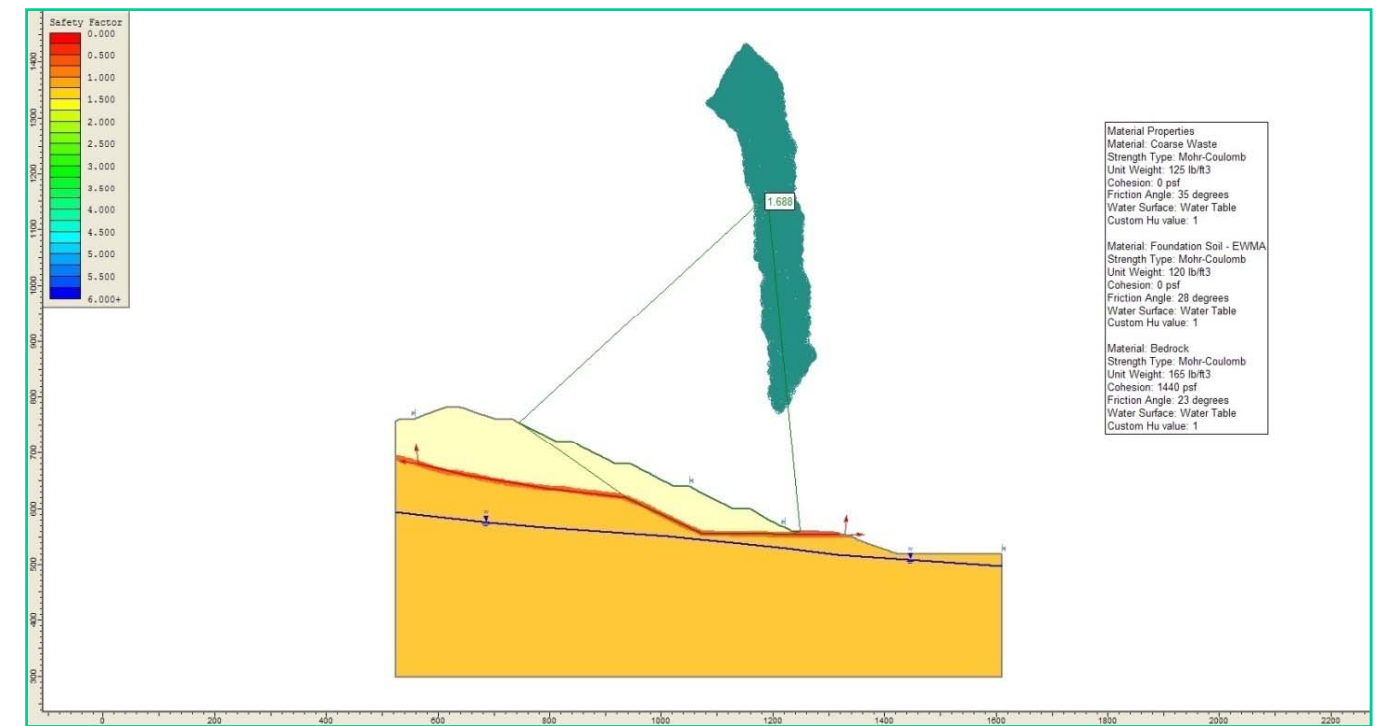
Stage	1	2	3
MC, %	52.5		
Dry Dens., pcf.	68.7		
Sat. %	97.4		
Void Ratio	1.454		
Diameter in	2.41		
Height, in	5.00		
Final			
MC, %	22.8	19.2	17.7
Dry Dens., pcf.	77.7	81.3	82.9
Sat. %	100.0	100.0	100.0
Void Ratio	0.615	0.519	0.478
Diameter, in	2.34	2.28	2.32
Height, in	4.68	4.70	4.48
Cell, psi	70.0	120.0	170.0
BP, psi	50.7	50.7	51.0
Effective Stresses At:			
Strain, %	5.0	5.0	5.0
Deviator ksf	1.701	6.973	14.476
Excess PP	2.015	7.164	11.145
Sigma 1	2.466	9.787	20.470
Sigma 3	0.764	2.814	5.993
P, ksf	1.615	6.301	13.231
Q, ksf	0.851	3.486	7.238
Stress Ratio	3.226	3.478	3.415
Rate in/min	0.001	0.001	0.001
Total C	0	Effective C	0.0
Total Phi	16.1	Effective Phi	33.8

APPENDIX C

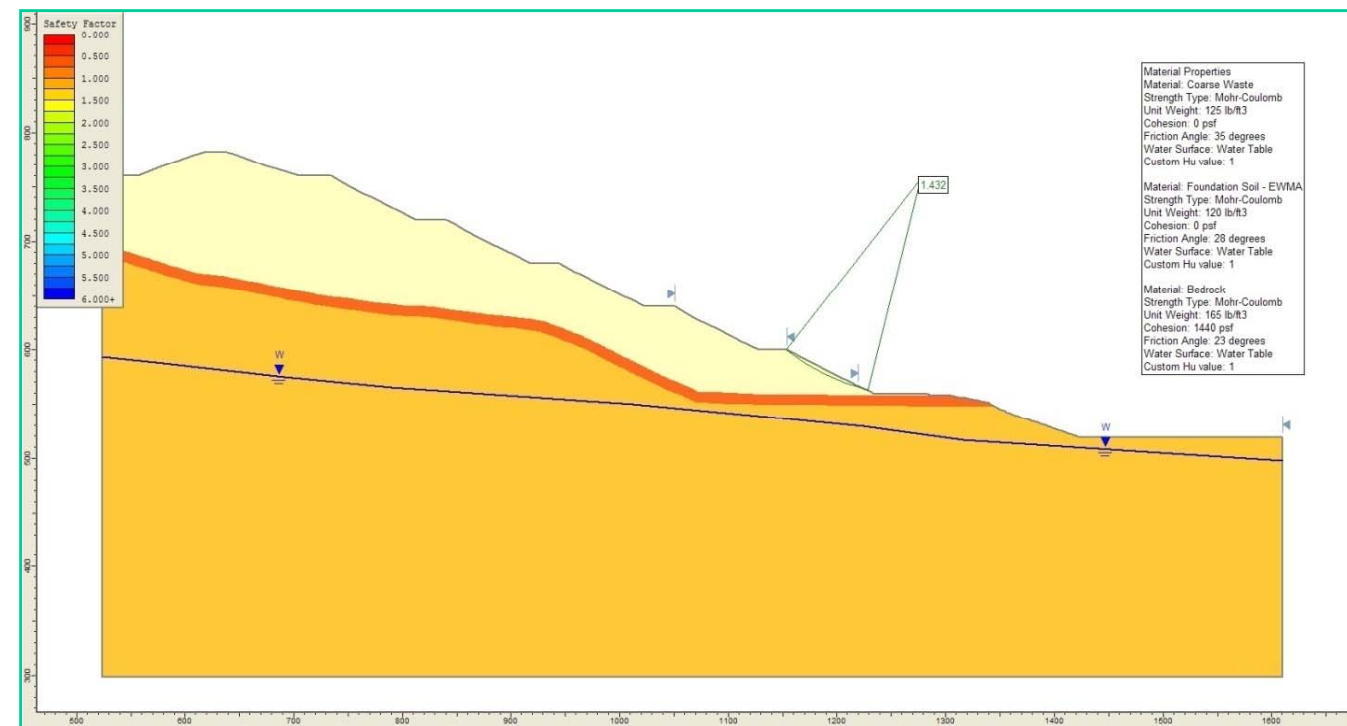
SLOPE STABILITY EVALUATION OF PROPOSED RECLAMATION PLAN – EAST MATERIALS STORAGE AREA



**SECTION E1 – STATIC
 GLOBAL FAILURE - CIRCULAR
 (FOS = 1.68)**



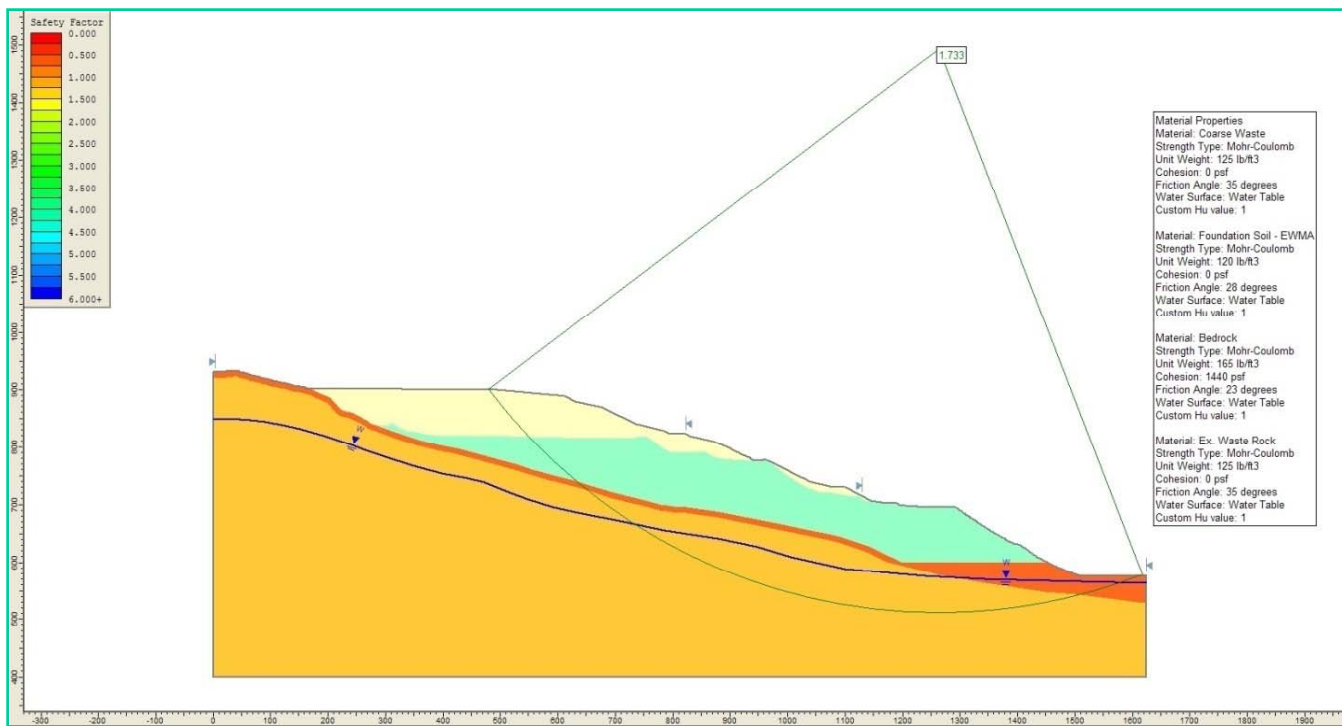
**SECTION E1 – STATIC
 GLOBAL FAILURE - BLOCK
 (FOS = 1.69)**



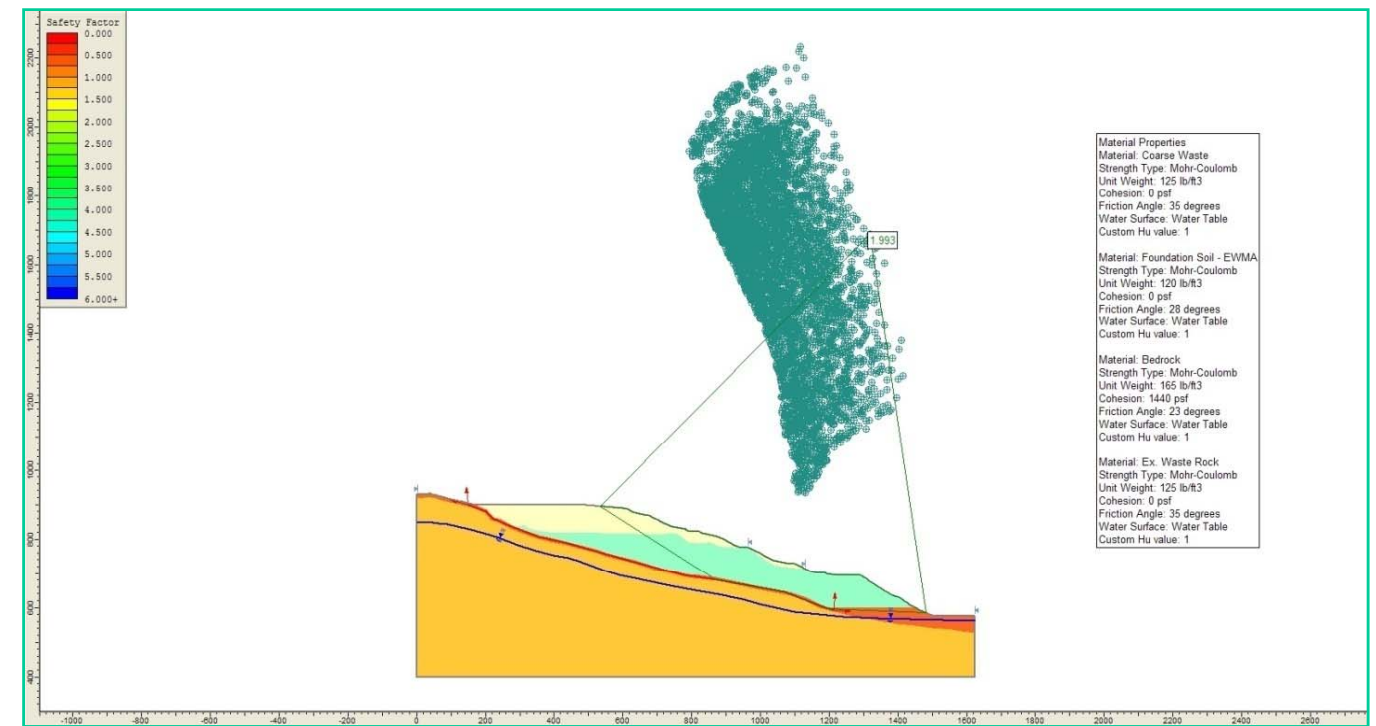
**SECTION E1 – STATIC
 SINGLE-LIFT FAILURE
 (FOS = 1.43)**

APPENDIX C1
 EMSA STABILITY REVIEW
 PERMANENTE QUARRY, CALIFORNIA
 STATIC ANALYSES OF PROPOSED
 RECLAMATION SLOPE – SECTION E1

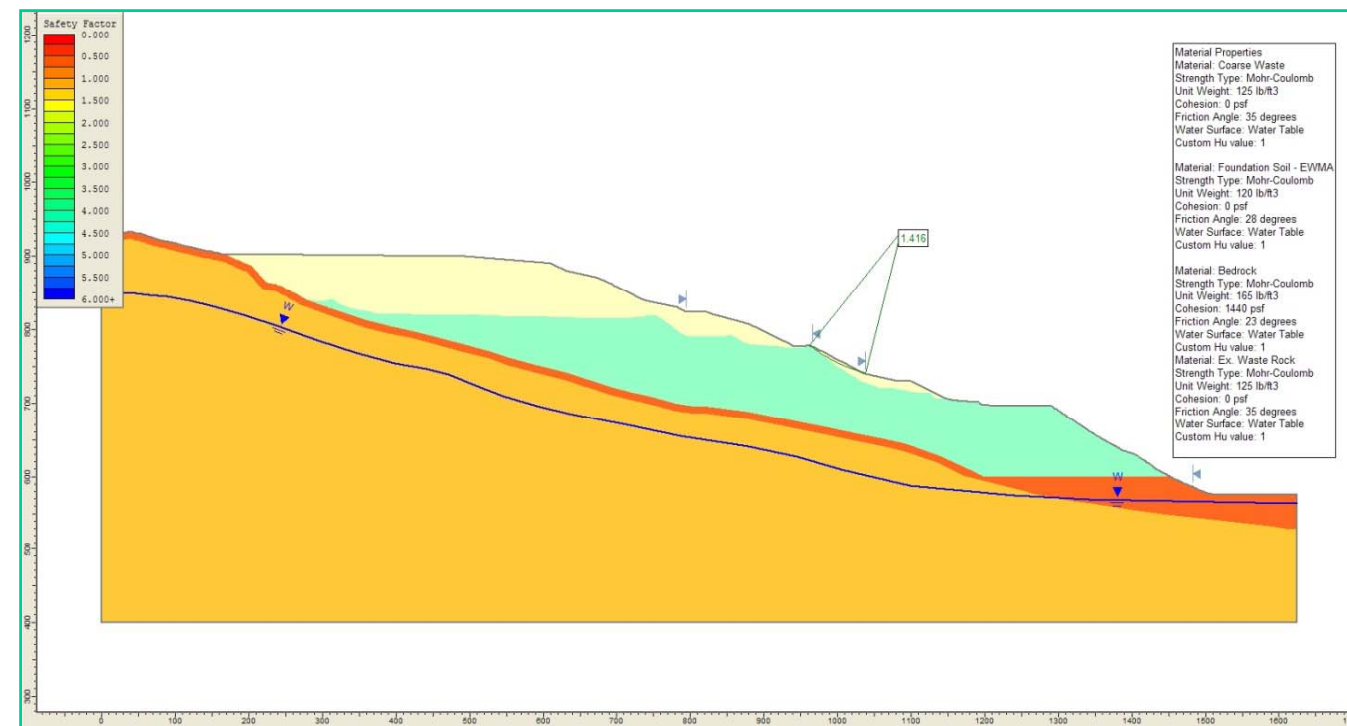




**SECTION E3 – STATIC
 GLOBAL FAILURE - CIRCULAR
 (FOS = 1.73)**



**SECTION E3 –STATIC
 GLOBAL FAILURE - BLOCK
 (FOS = 1.99)**

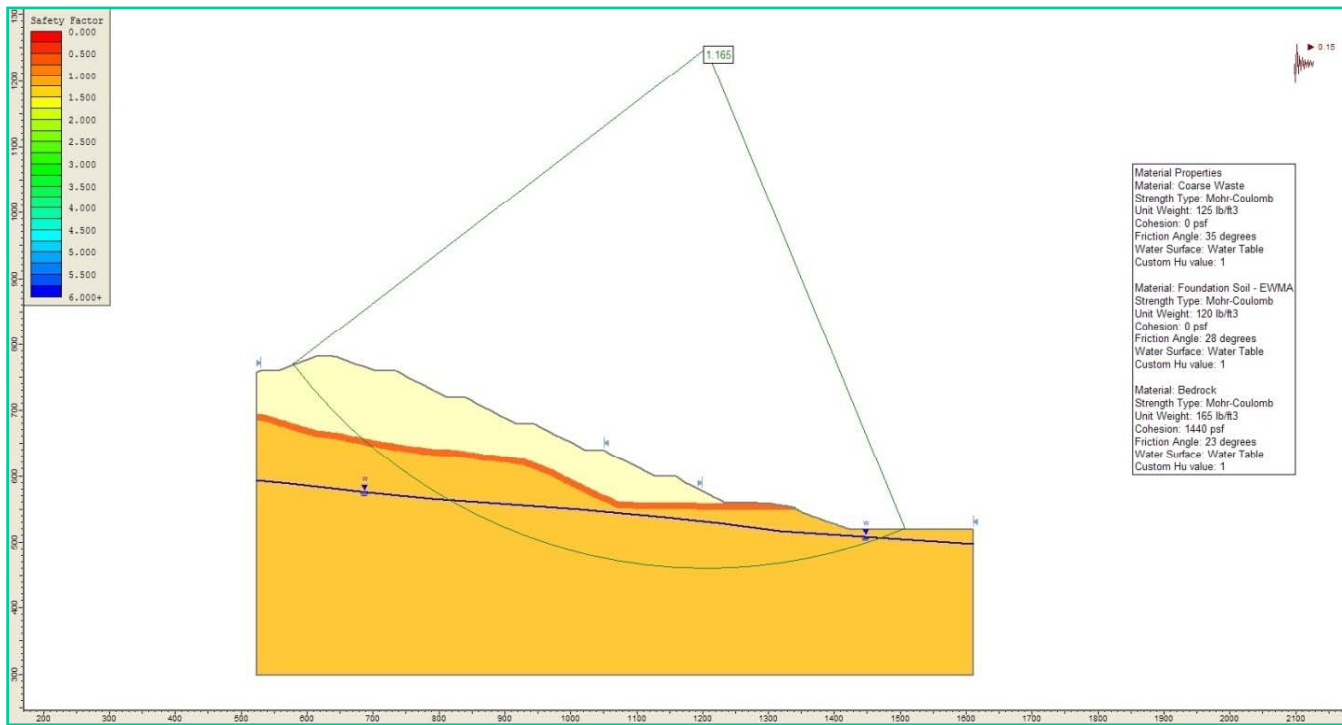


**SECTION E3 –STATIC
 SINGLE-LIFT FAILURE
 (FOS = 1.42)**

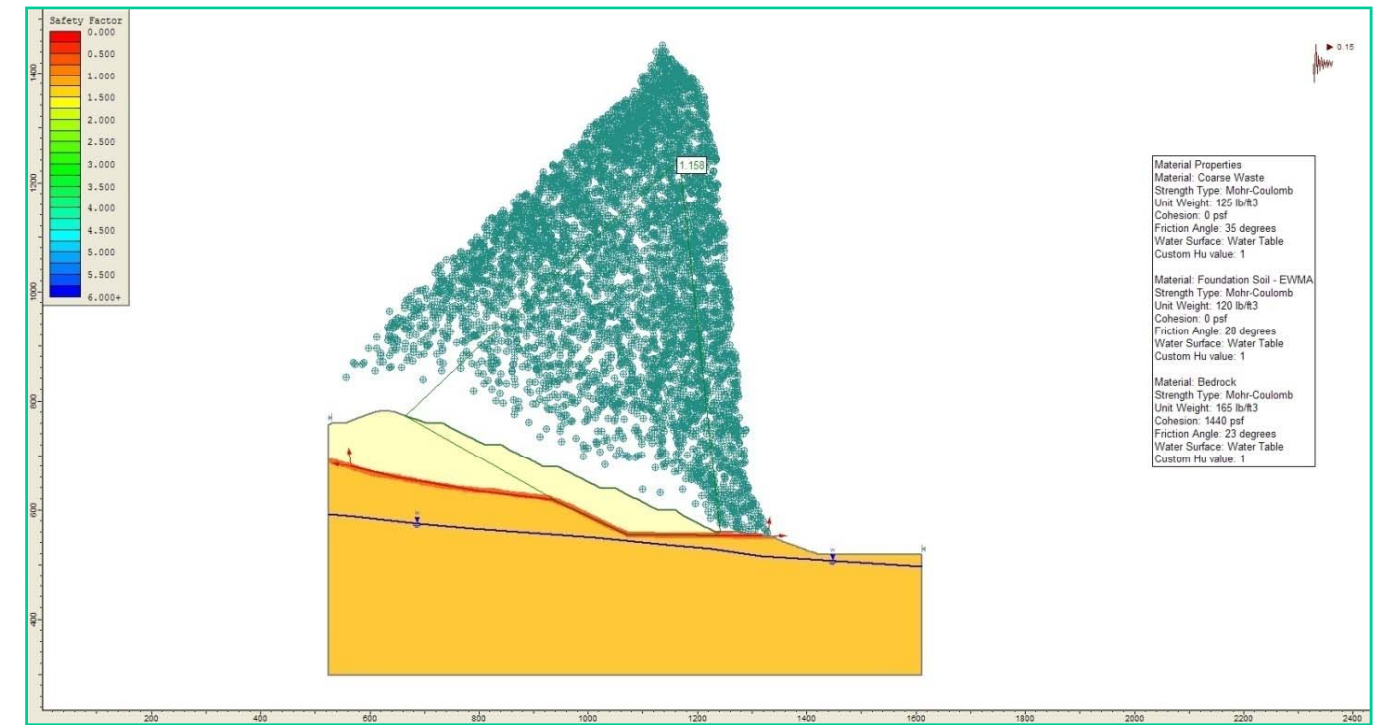
**APPENDIX C2
 EMSA STABILITY REVIEW
 PERMANENTE QUARRY, CALIFORNIA**

STATIC ANALYSES OF PROPOSED
 RECLAMATION SLOPE – SECTION E3

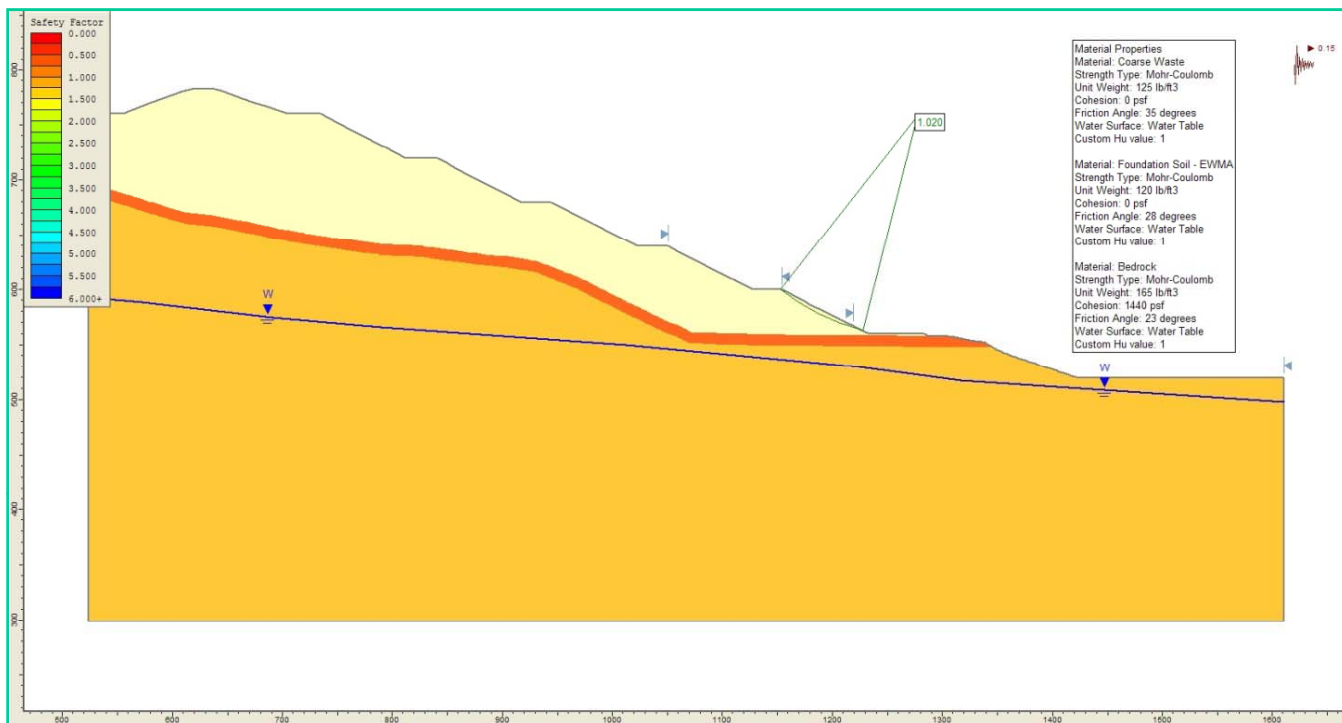




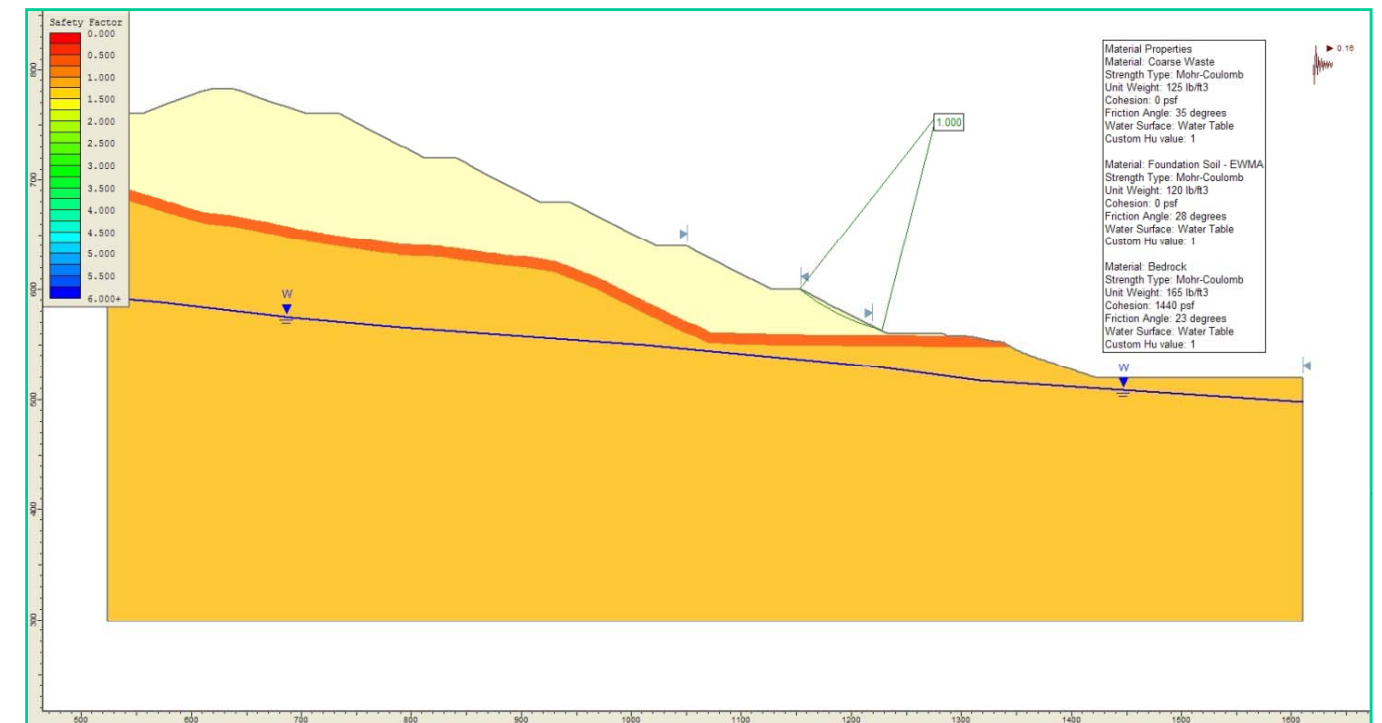
**SECTION E3 – PSEUDO-STATIC
 GLOBAL FAILURE - CIRCULAR
 (FOS = 1.17)**



**SECTION E3 – PSEUDO-STATIC
 GLOBAL FAILURE - BLOCK
 (FOS = 1.16)**



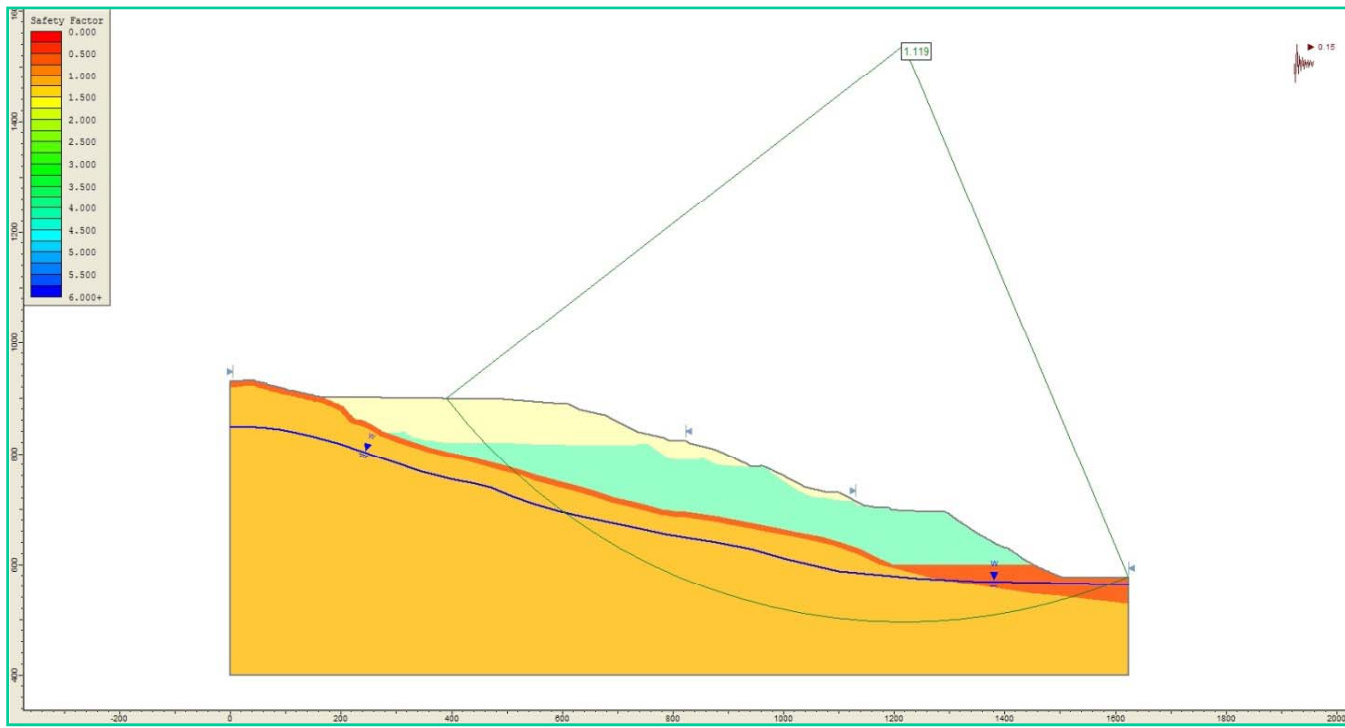
**SECTION E3 – PSEUDO-STATIC
 SINGLE-LIFT FAILURE
 (FOS = 1.02)**



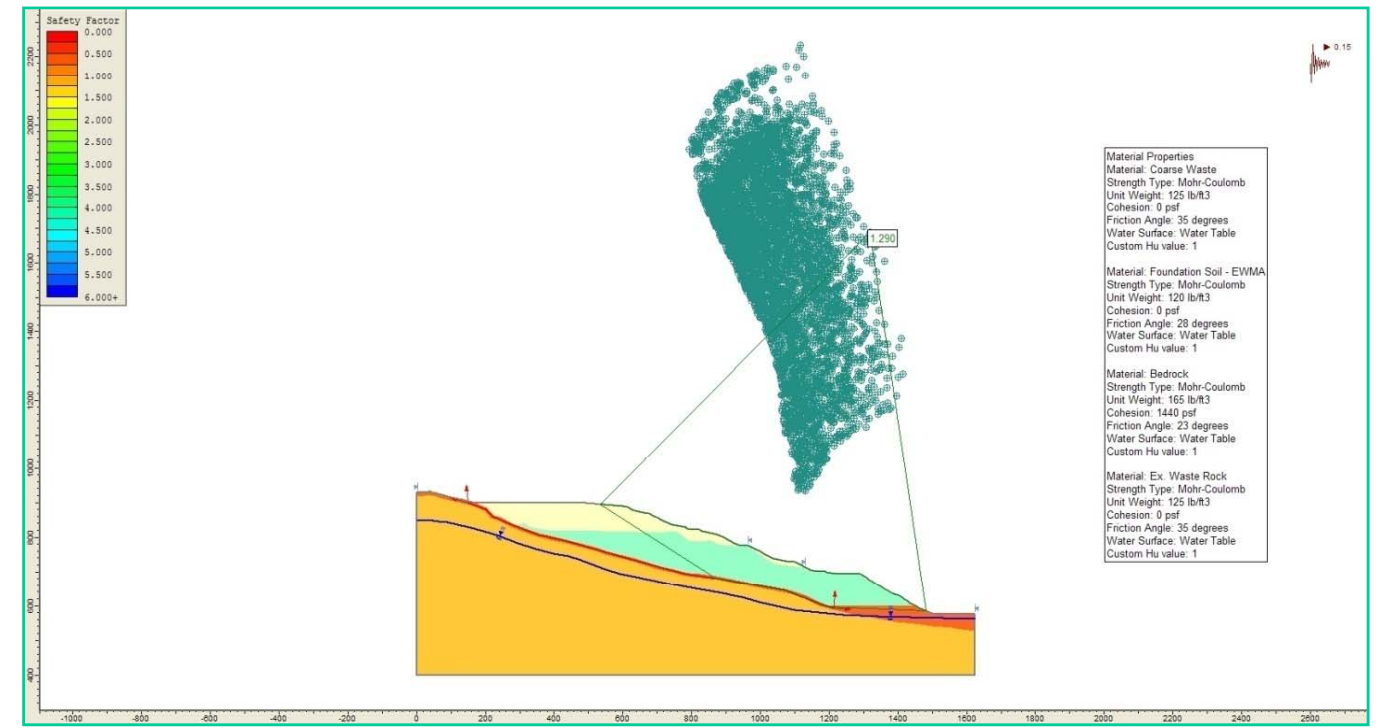
**SECTION E3 – YIELD ACCELERATION
 SINGLE-LIFT FAILURE
 (ky = 0.16g)**



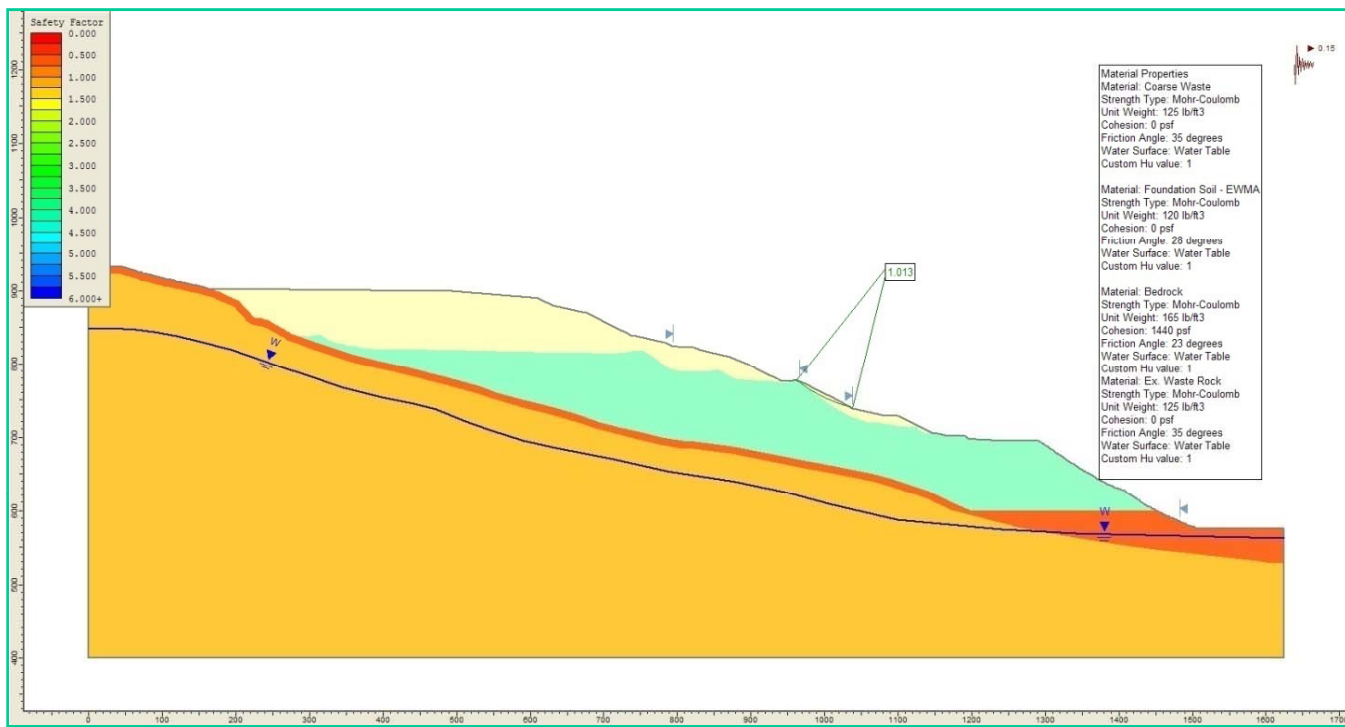
APPENDIX C3
 EMSA STABILITY REVIEW
 PERMANENTE QUARRY, CALIFORNIA
 SEISMIC STABILITY OF PROPOSED
 RECLAMATION SLOPE - SECTION E1



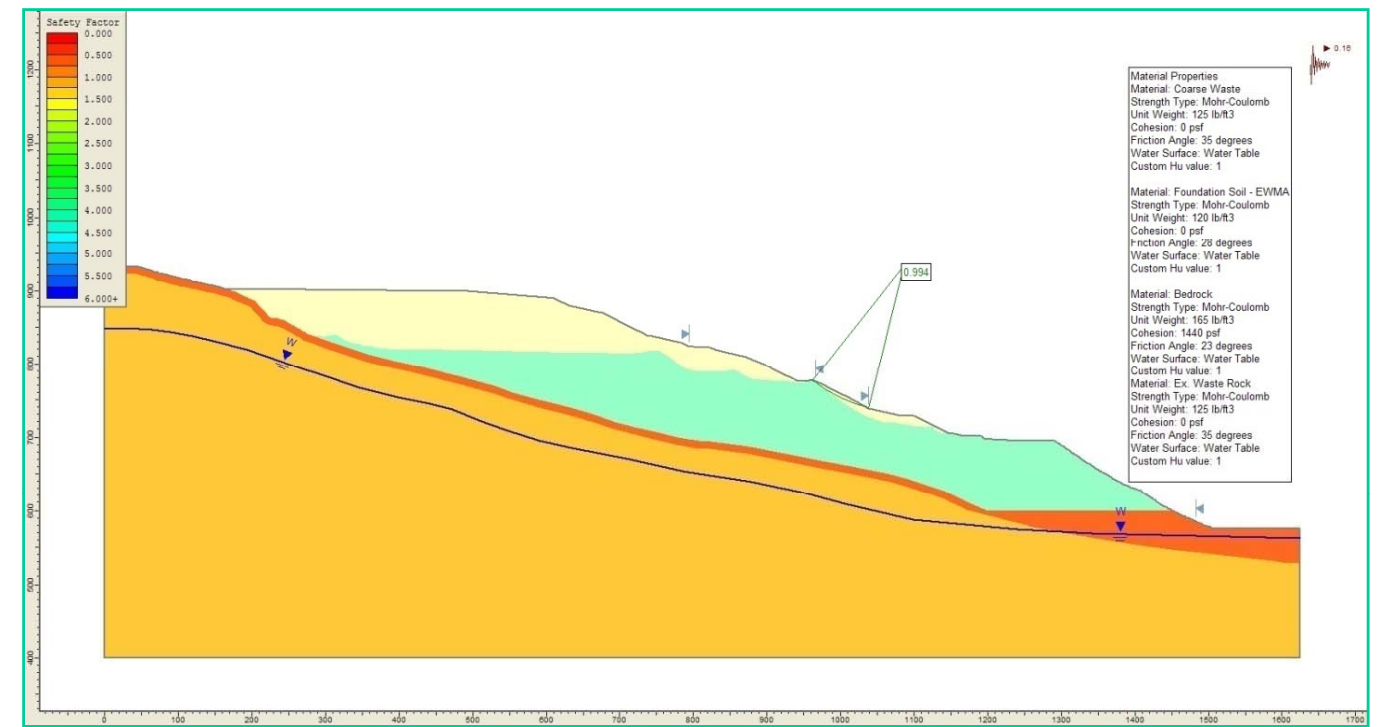
**SECTION E3 – PSEUDO-STATIC
GLOBAL FAILURE - CIRCULAR
(FOS = 1.12)**



**SECTION E3 – PSEUDO-STATIC
GLOBAL FAILURE - BLOCK
(FOS = 1.29)**



**SECTION E3 – PSEUDO-STATIC
SINGLE-LIFT FAILURE
(FOS = 1.01)**

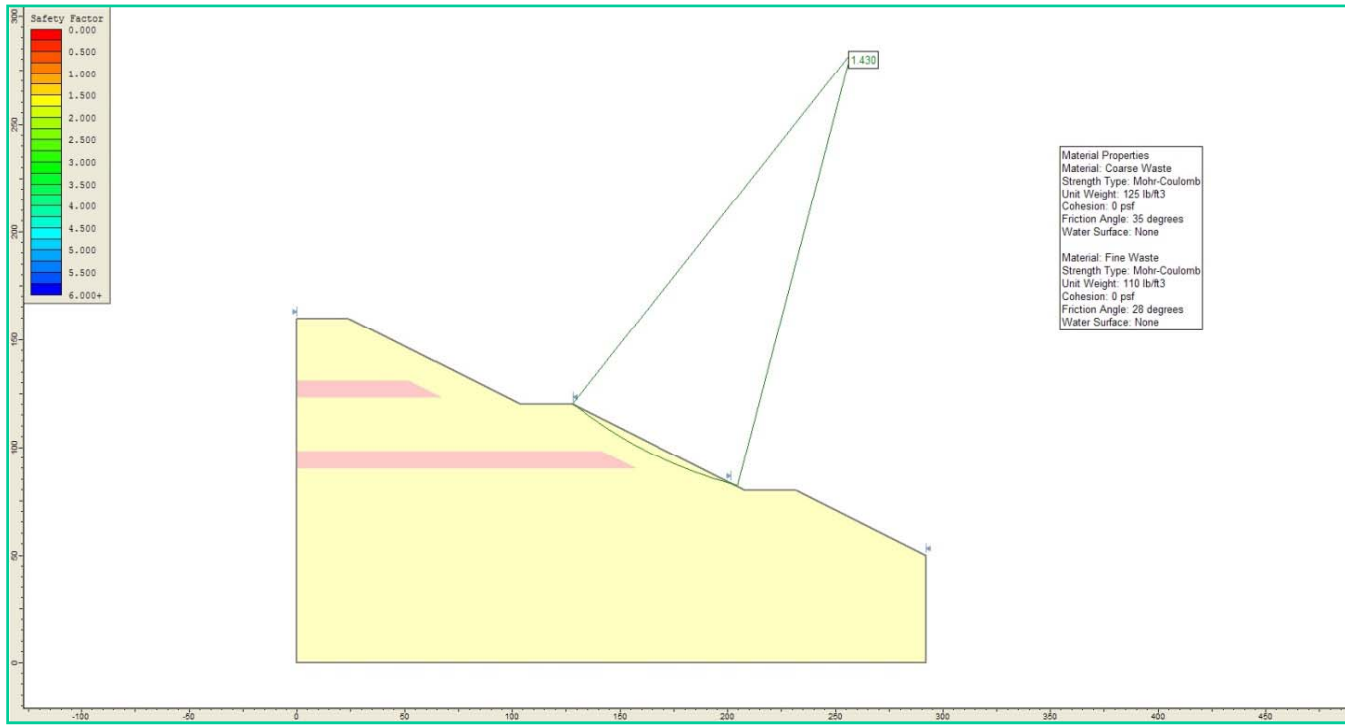


**SECTION E3 – YIELD ACCELERATION
SINGLE-LIFT FAILURE
(ky = 0.16g)**

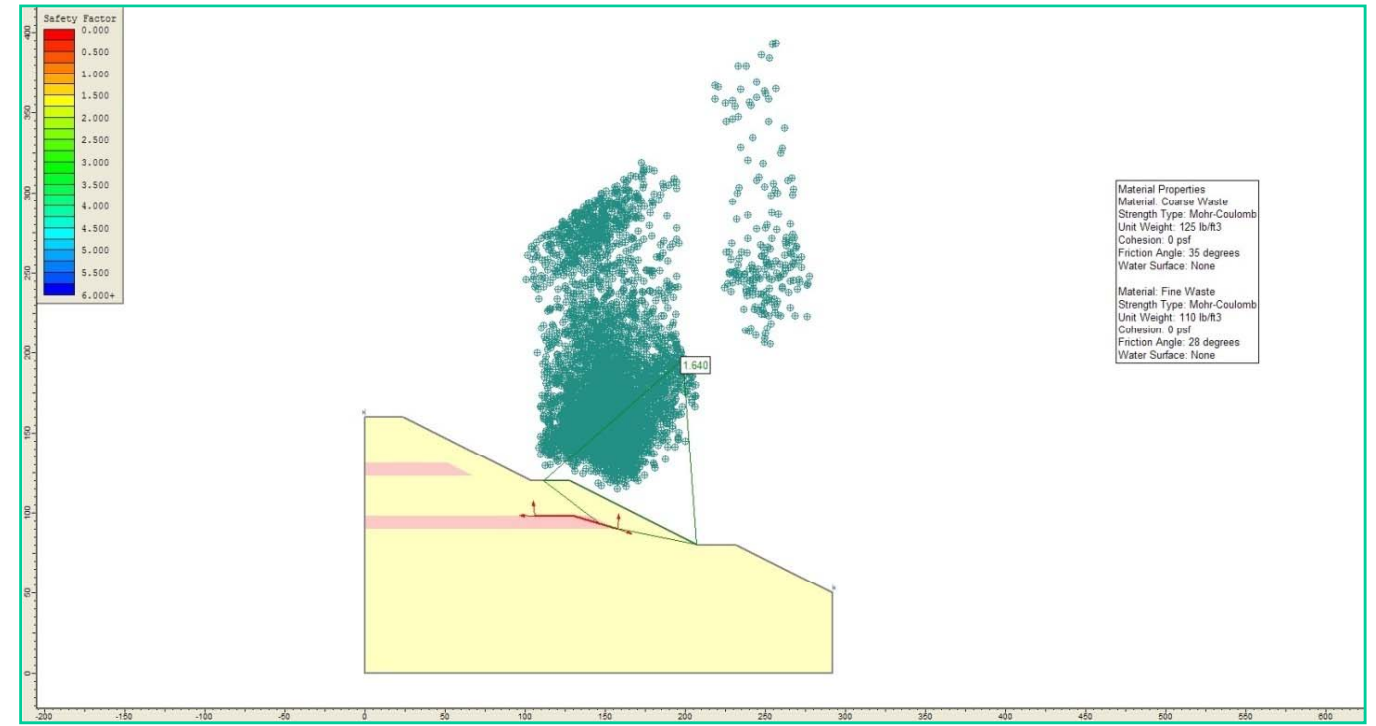


APPENDIX C4
 EMSA STABILITY REVIEW
 PERMANENTE QUARRY, CALIFORNIA

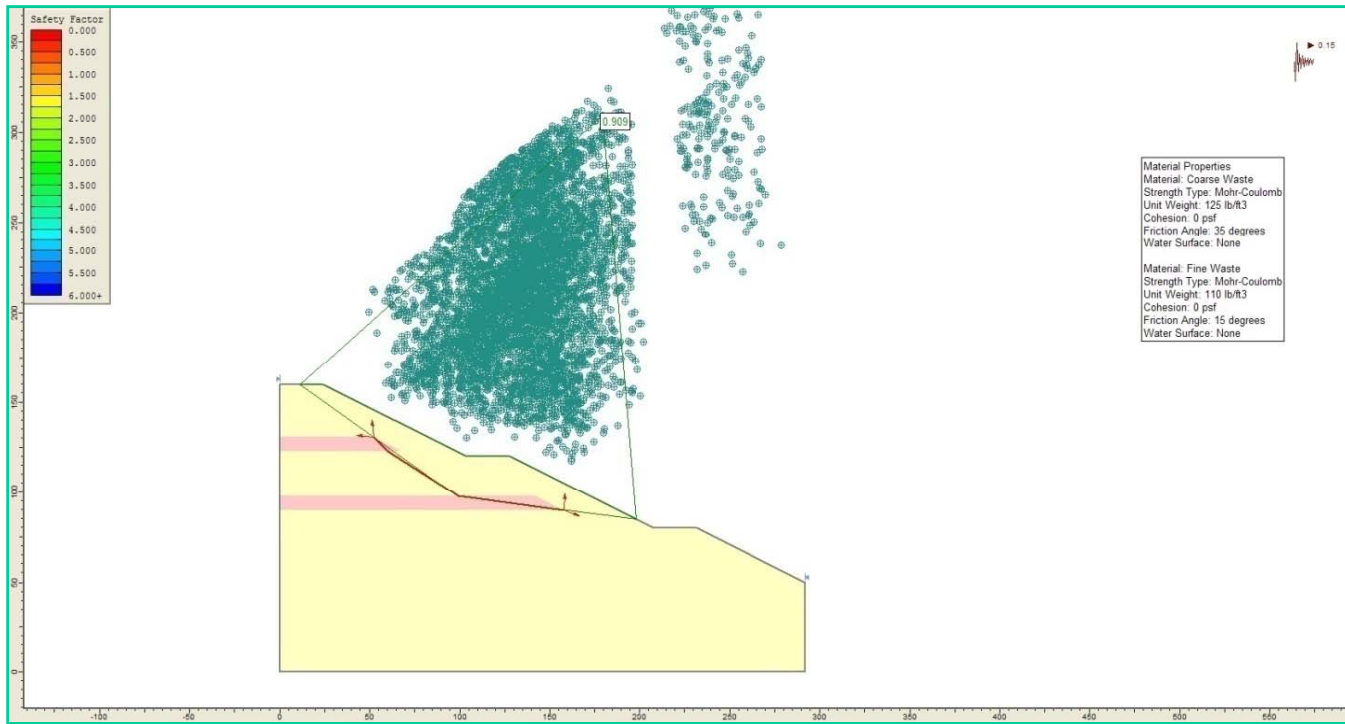
SEISMIC STABILITY OF PROPOSED
 RECLAMATION SLOPE – SECTION E3



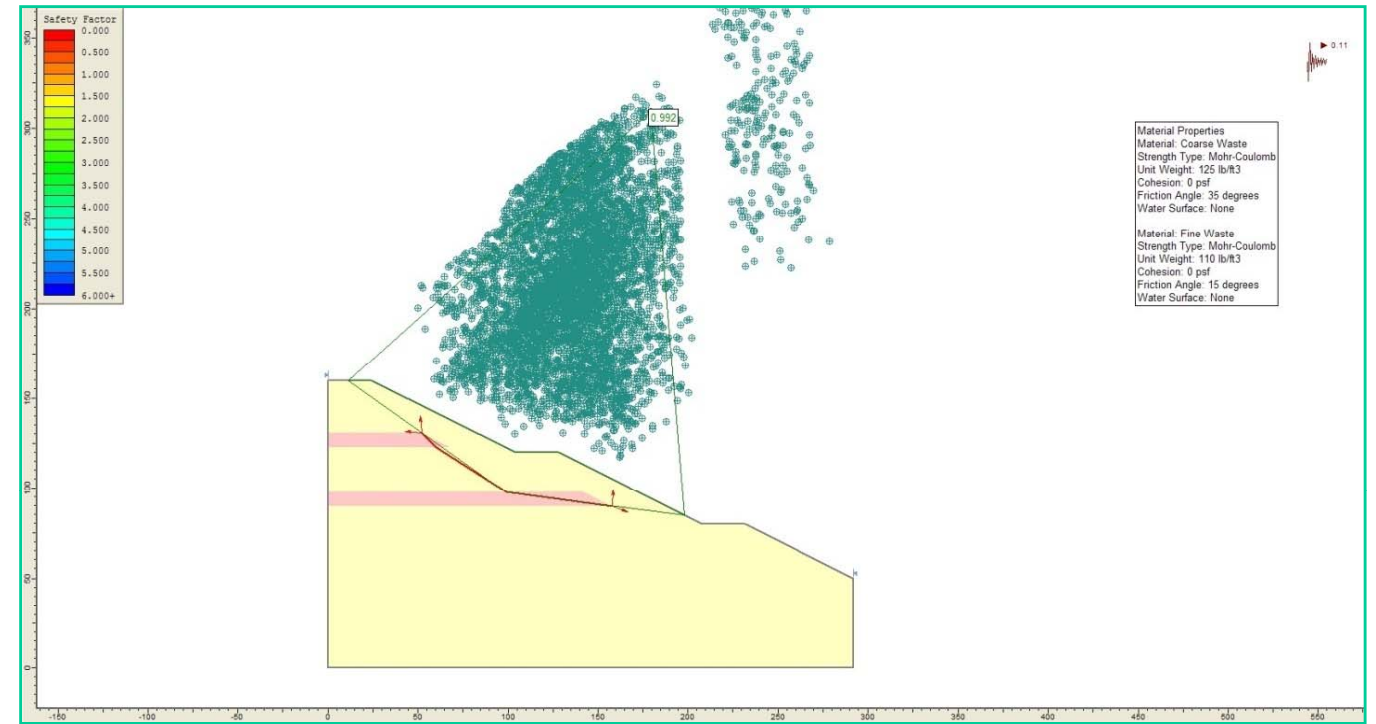
CONCEPTUAL SECTION – STATIC
 LOCAL FAILURE - CIRCULAR
 (FOS = 1.43)



CONCEPTUAL SECTION – STATIC
 LOCAL BLOCK FAILURE THROUGH FINE WASTE
 (FOS = 1.64)



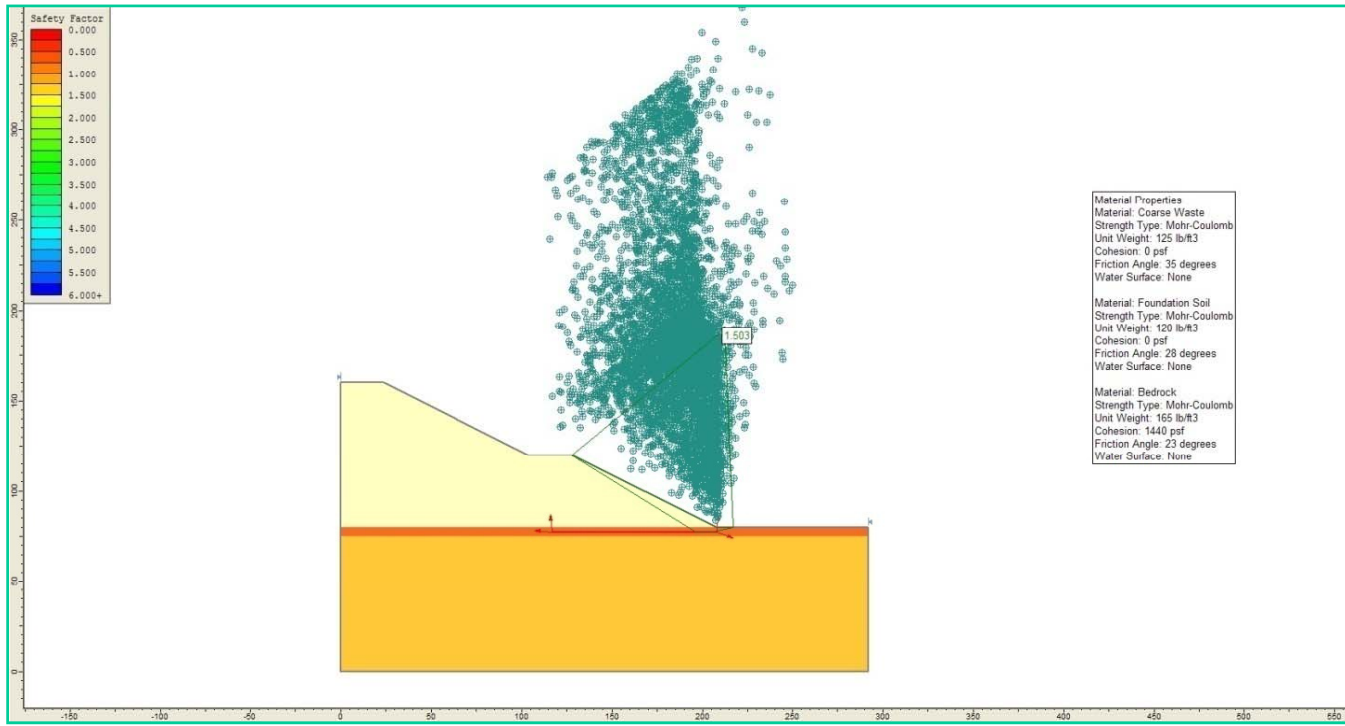
CONCEPTUAL SECTION – PSEUDO-STATIC
 LOCAL BLOCK FAILURE THROUGH FINE WASTE
 (FOS = 0.91)



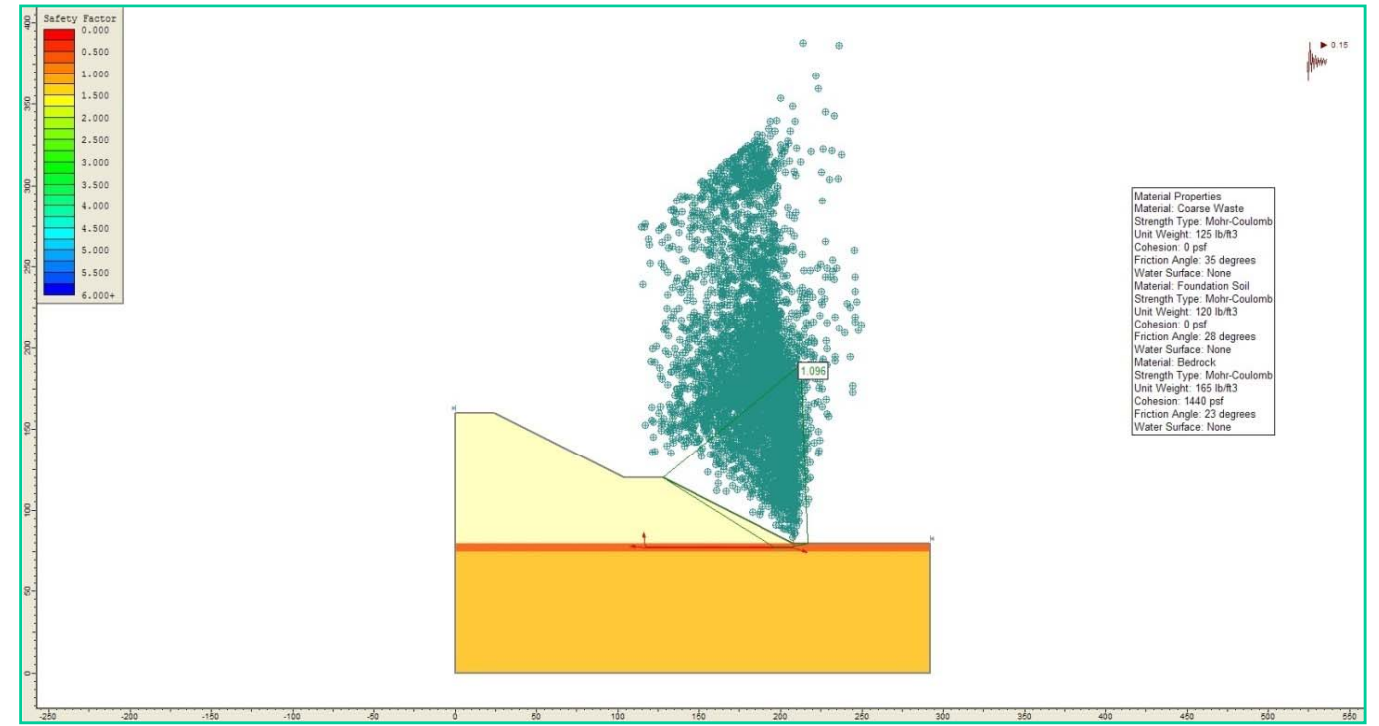
CONCEPTUAL SECTION – YIELD ACCELERATION
 LOCAL BLOCK FAILURE THROUGH FINE WASTE
 (ky = 0.11g)



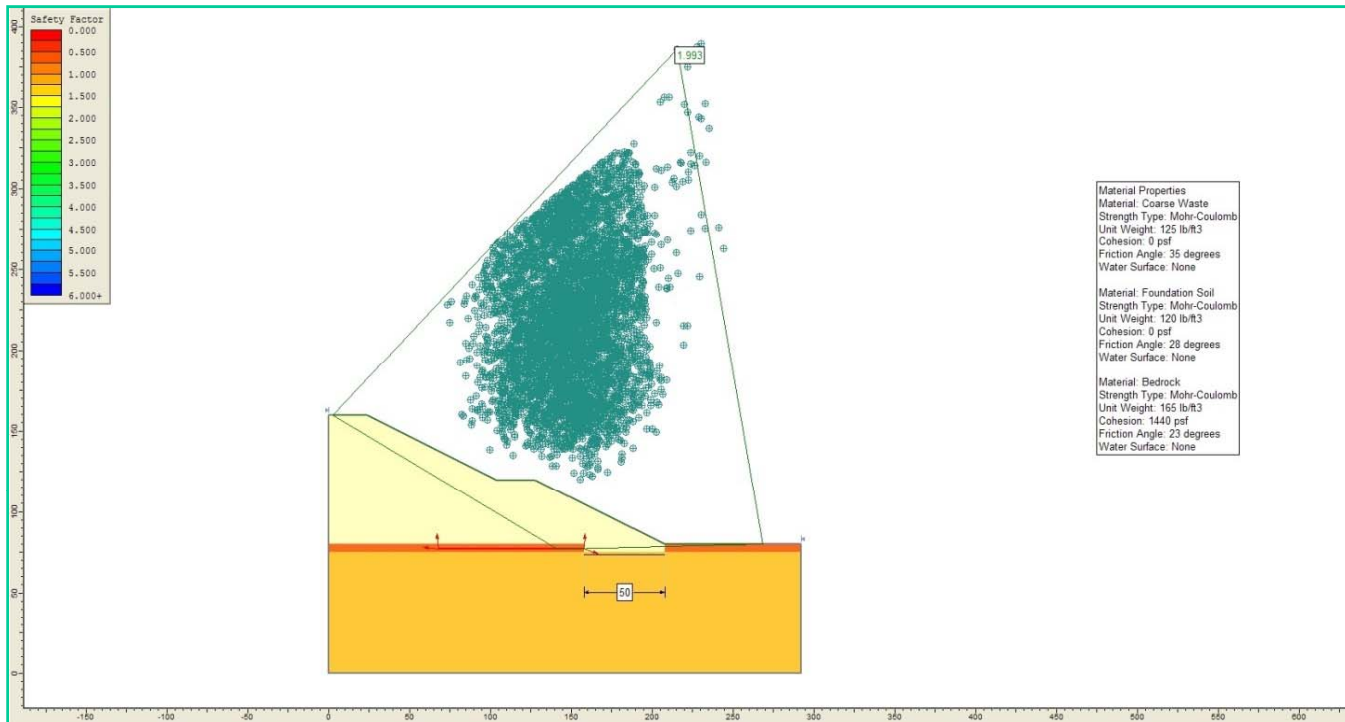
APPENDIX C5
 EMSA STABILITY REVIEW
 PERMANENTE QUARRY, CALIFORNIA
 LOCAL STABILITY OF RECLAIMED SLOPES
 WITH FINE WASTE



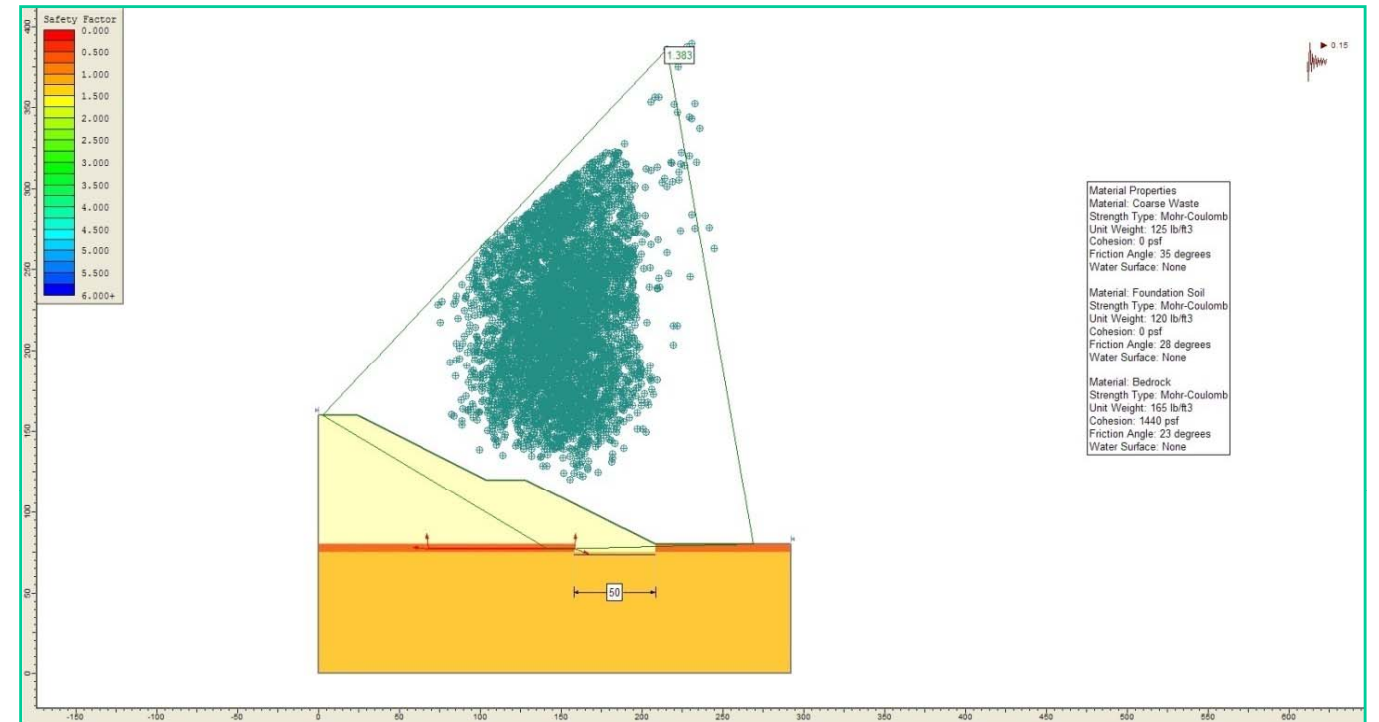
**CONCEPTUAL MODEL OF UNPREPARED SUBGRADE – STATIC
LOCAL BLOCK FAILURE THROUGH FOUNDATION SOIL (FLAT)
(FOS = 1.50)**



**CONCEPTUAL MODEL OF UNPREPARED SUBGRADE – PSEUDO-STATIC
LOCAL BLOCK FAILURE THROUGH FOUNDATION SOIL (FLAT)
(FOS = 1.10)**



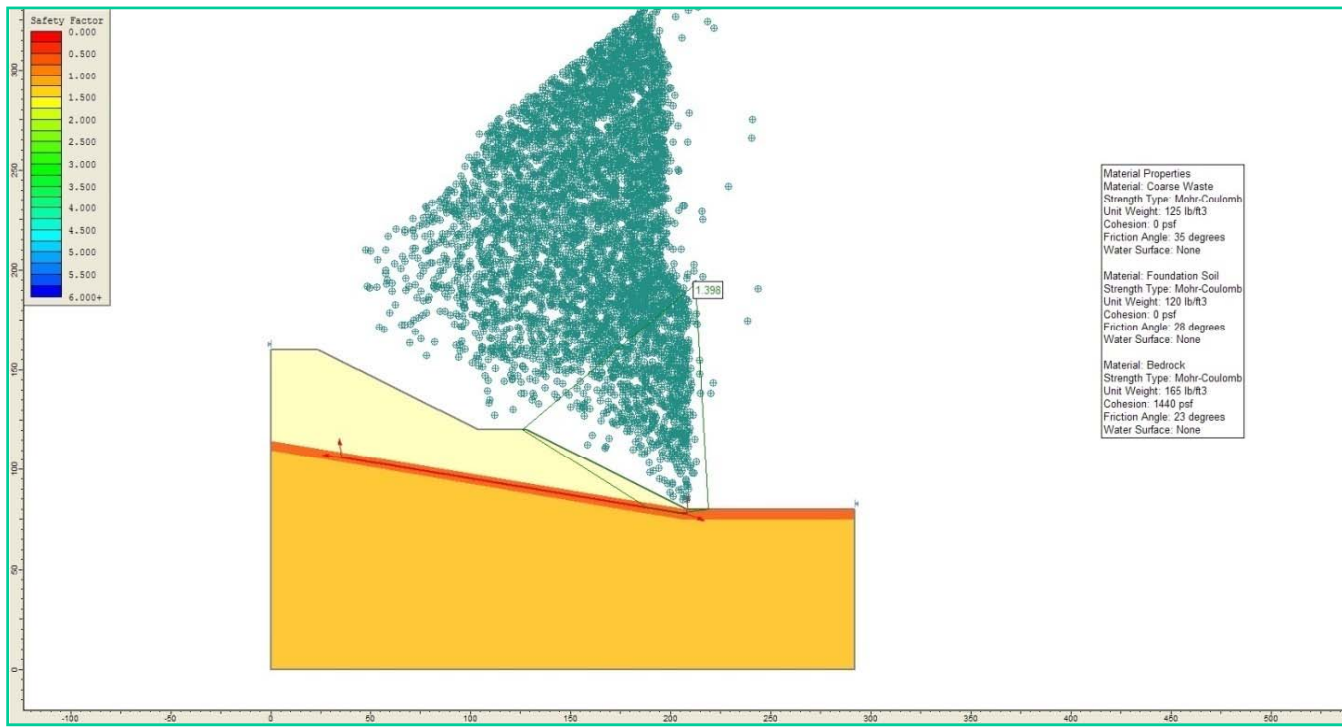
**CONCEPTUAL MODEL OF PREPARED SUBGRADE – STATIC
LOCAL BLOCK FAILURE THROUGH FOUNDATION SOIL (FLAT)
(FOS = 1.99)**



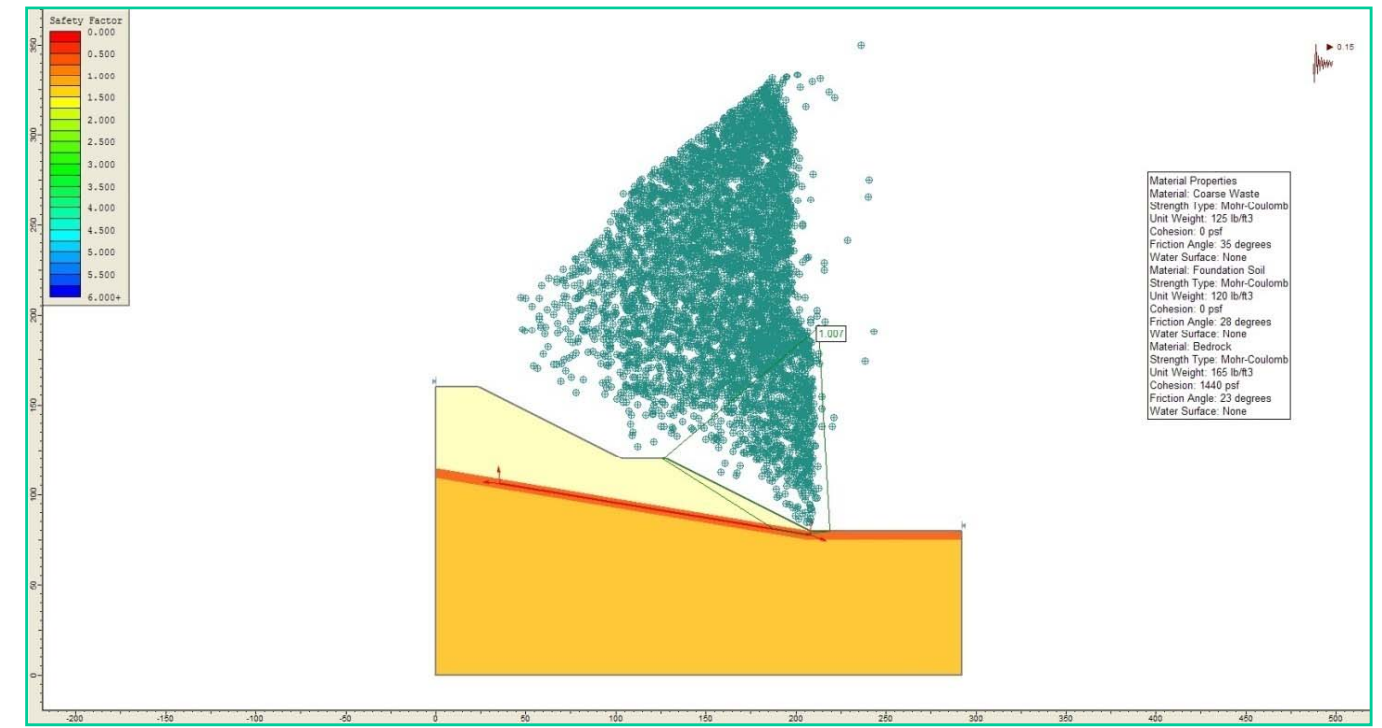
**CONCEPTUAL MODEL OF UNPREPARED SUBGRADE – PSEUDO-STATIC
LOCAL BLOCK FAILURE THROUGH FOUNDATION SOIL (FLAT)
(FOS = 1.38)**



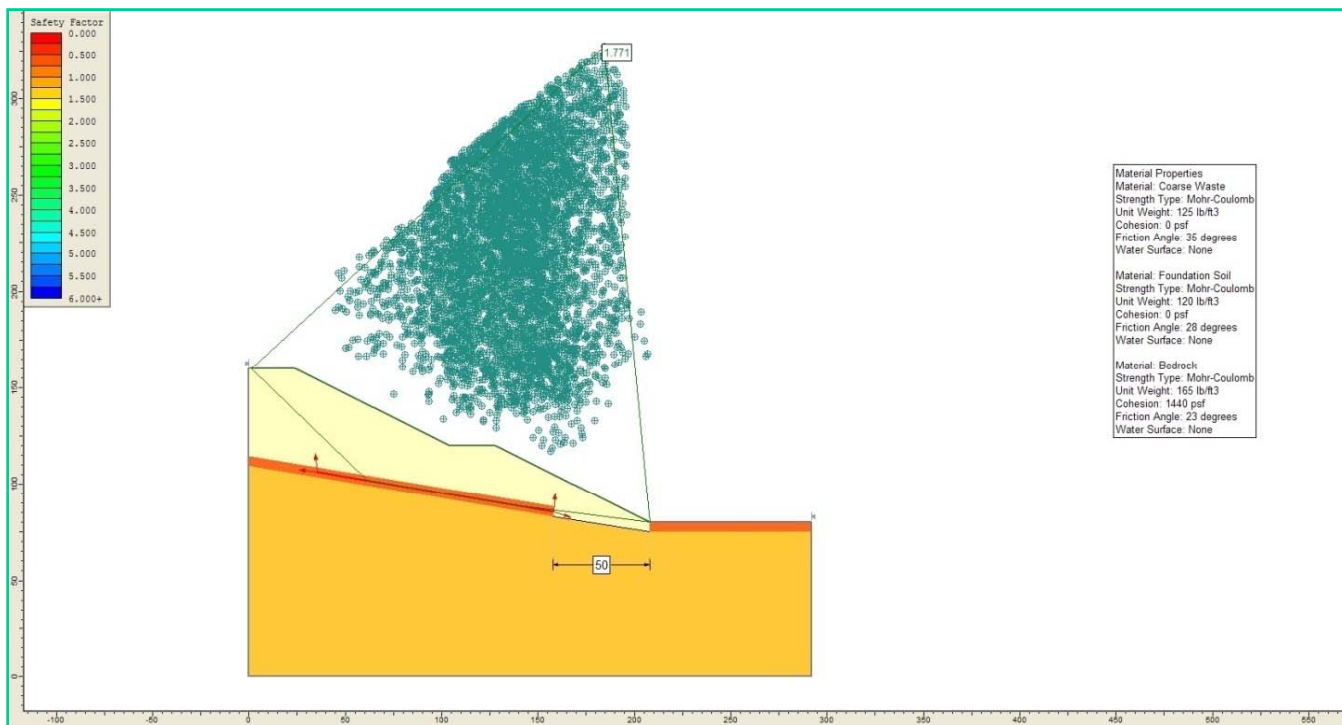
APPENDIX C6
EMSA STABILITY REVIEW
PERMANENTE QUARRY, CALIFORNIA
SENSITIVITY STUDY - VARIATION OF
SUBGRADE (FLAT)



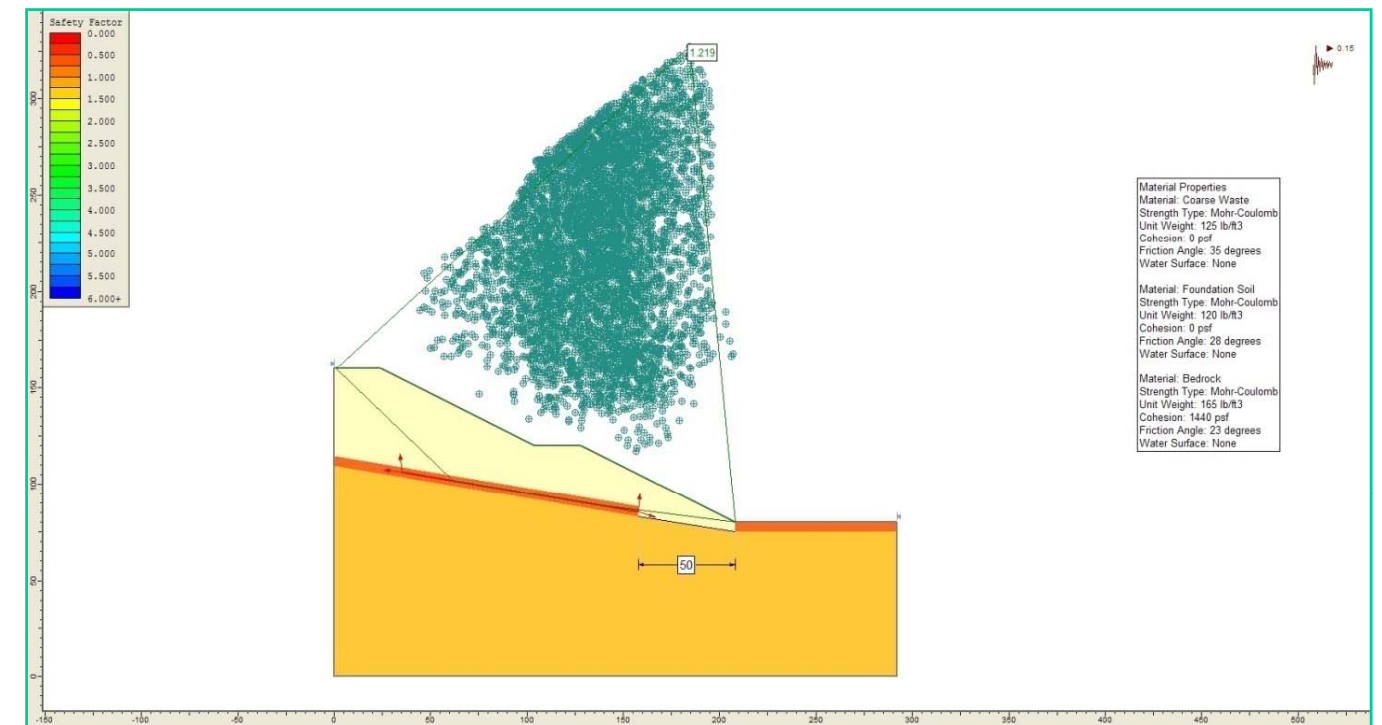
**CONCEPTUAL MODEL OF UNPREPARED SUBGRADE – STATIC
 LOCAL BLOCK FAILURE THROUGH FOUNDATION SOIL (6H:1V)
 (FOS = 1.40)**



**CONCEPTUAL MODEL OF UNPREPARED SUBGRADE – PSEUDO-STATIC
 LOCAL BLOCK FAILURE THROUGH FOUNDATION SOIL (6H:1V)
 (FOS = 1.01)**



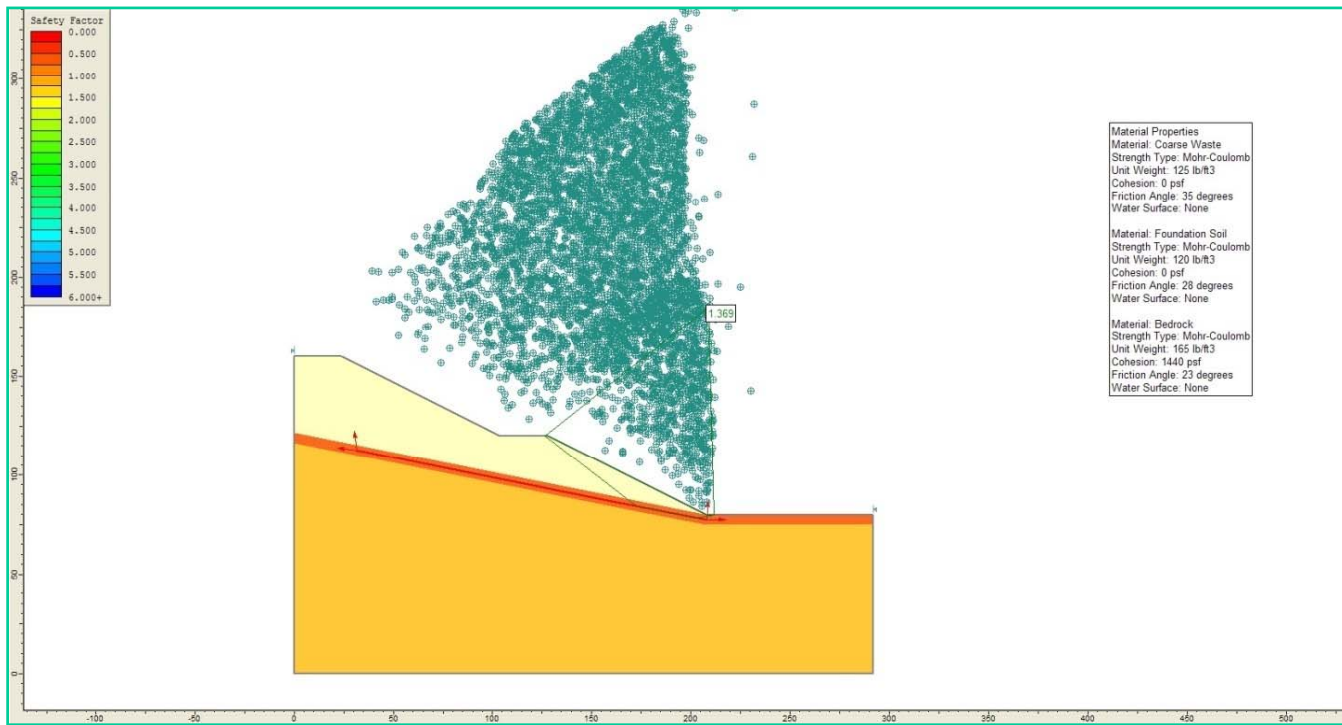
**CONCEPTUAL MODEL OF PREPARED SUBGRADE – STATIC
 LOCAL BLOCK FAILURE THROUGH FOUNDATION SOIL (6H:1V)
 (FOS = 1.77)**



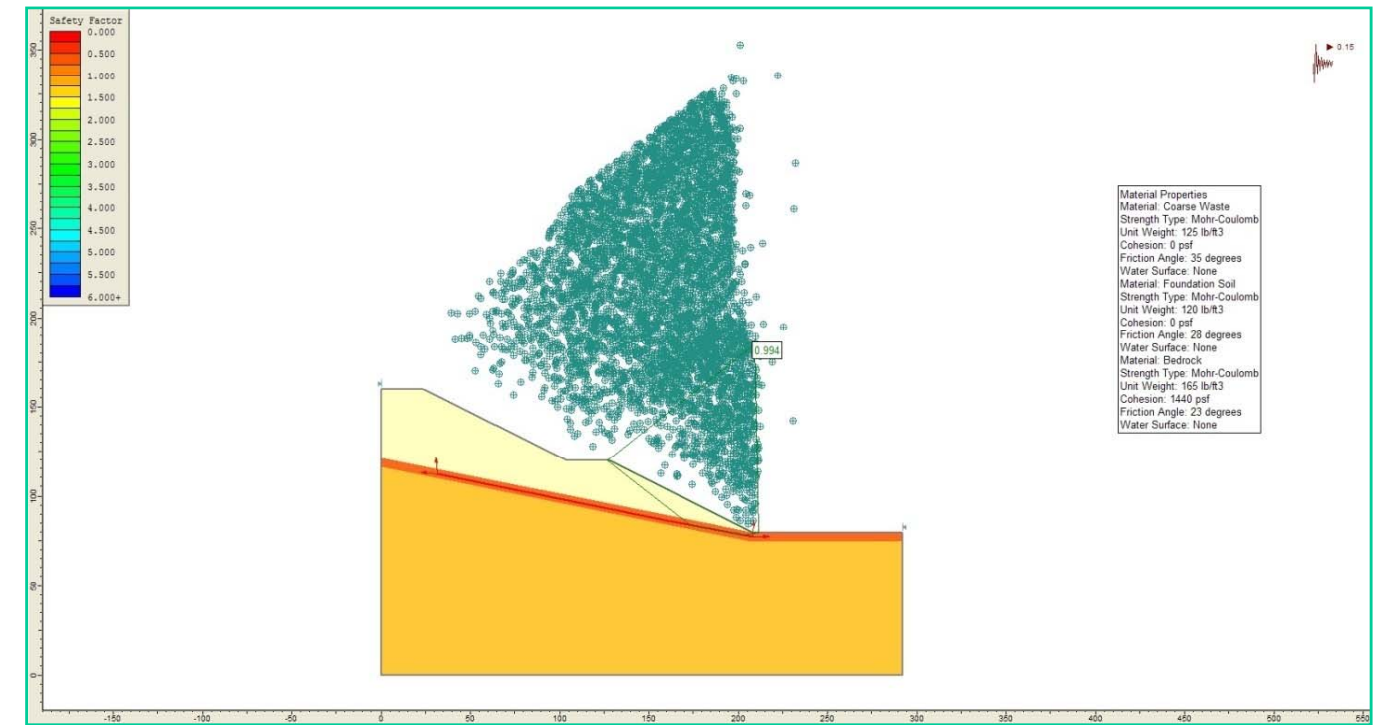
**CONCEPTUAL MODEL OF UNPREPARED SUBGRADE – PSEUDO-STATIC
 LOCAL BLOCK FAILURE THROUGH FOUNDATION SOIL (6H:1V)
 (FOS = 1.22)**



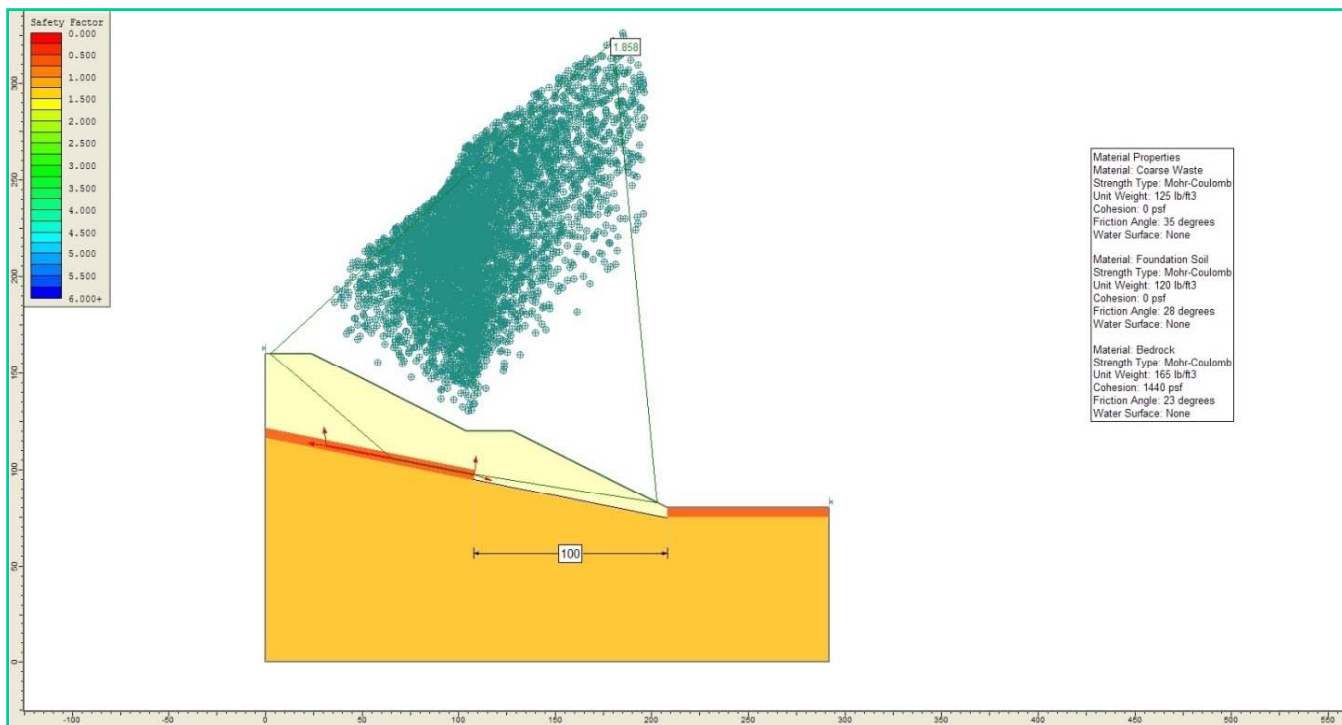
APPENDIX C7
 EMSA STABILITY REVIEW
 PERMANENTE QUARRY, CALIFORNIA
 SENSITIVITY STUDY - VARIATION OF
 SUBGRADE (6H:1V)



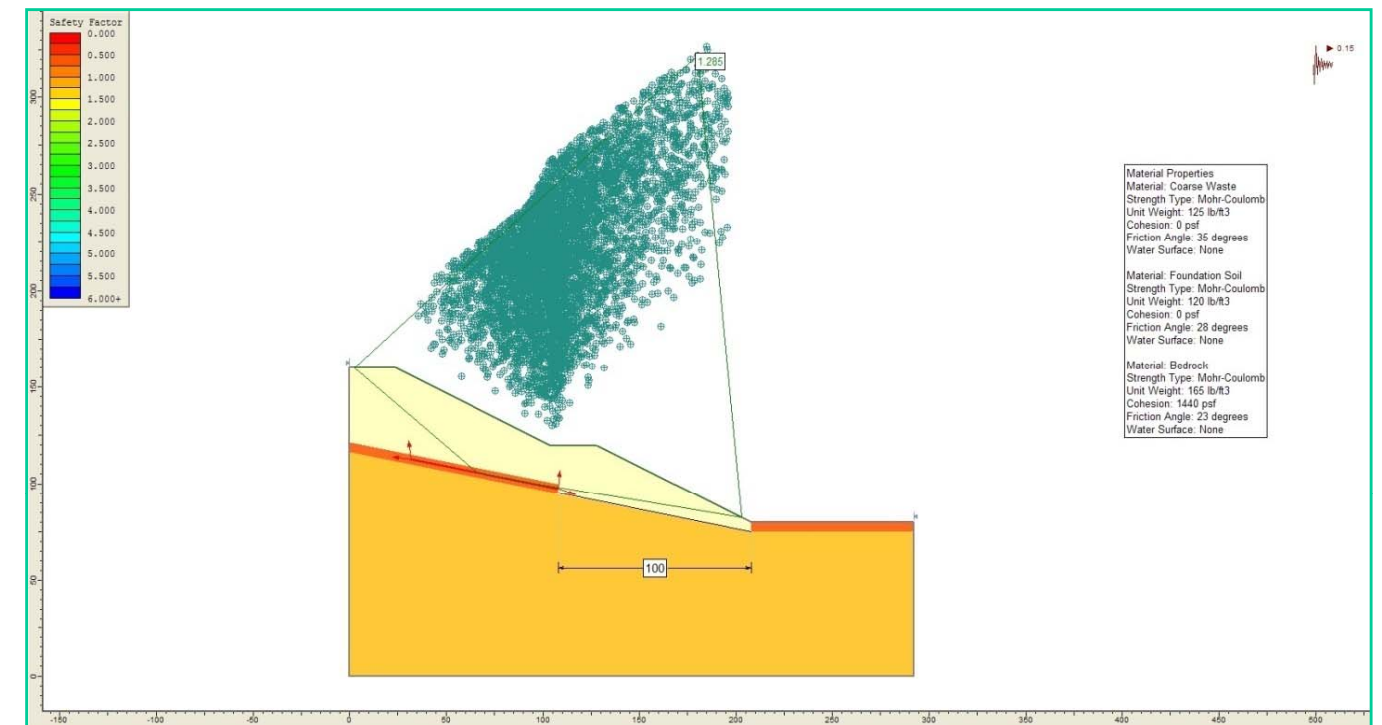
**CONCEPTUAL MODEL OF UNPREPARED SUBGRADE – STATIC
 LOCAL BLOCK FAILURE THROUGH FOUNDATION SOIL (5H:1V)
 (FOS = 1.37)**



**CONCEPTUAL MODEL OF UNPREPARED SUBGRADE – PSEUDO-STATIC
 LOCAL BLOCK FAILURE THROUGH FOUNDATION SOIL (5H:1V)
 (FOS = 0.99)**



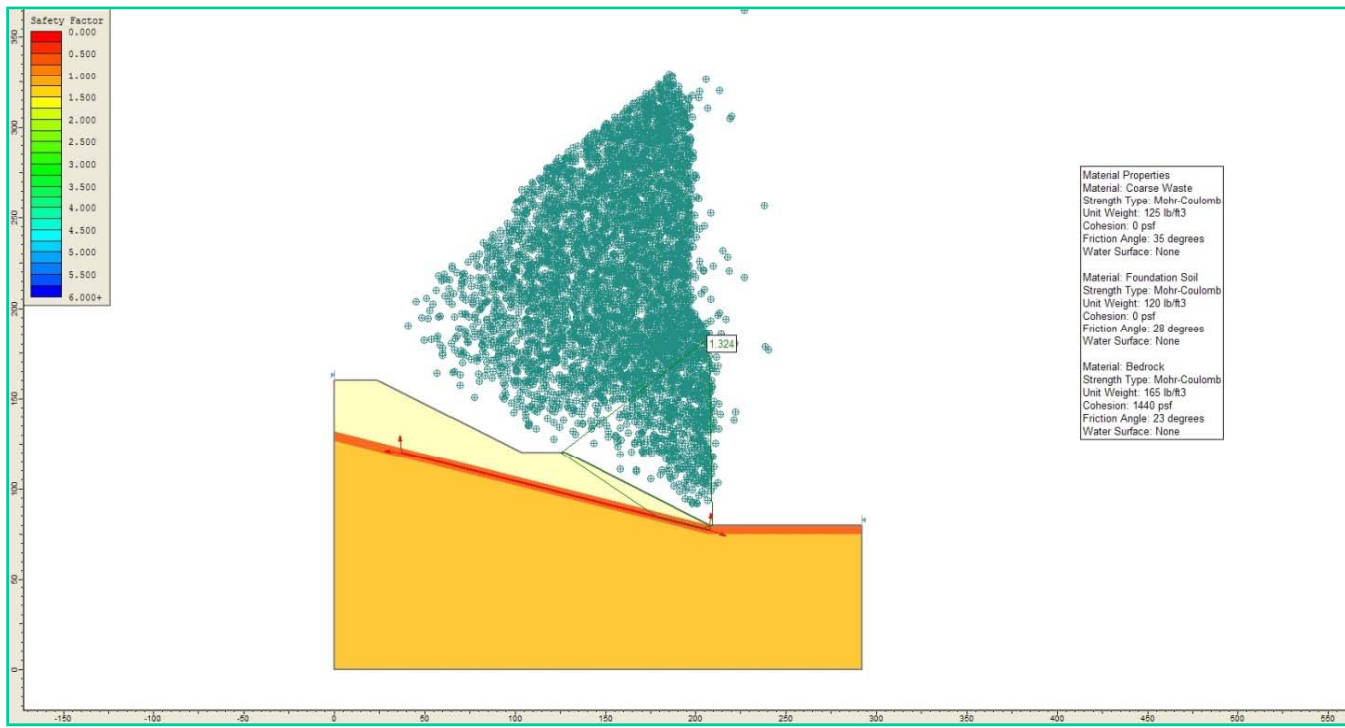
**CONCEPTUAL MODEL OF PREPARED SUBGRADE – STATIC
 LOCAL BLOCK FAILURE THROUGH FOUNDATION SOIL (5H:1V)
 (FOS = 1.86)**



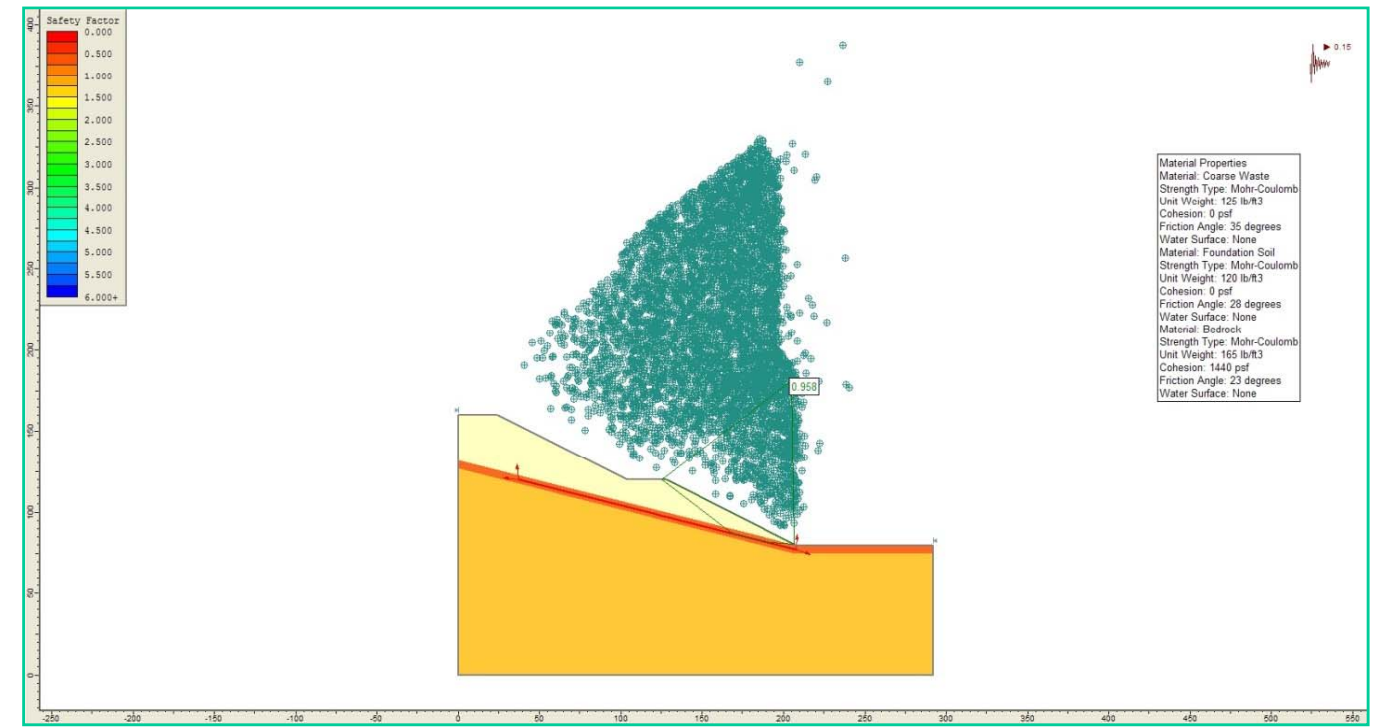
**CONCEPTUAL MODEL OF UNPREPARED SUBGRADE – PSEUDO-STATIC
 LOCAL BLOCK FAILURE THROUGH FOUNDATION SOIL (5H:1V)
 (FOS = 1.29)**



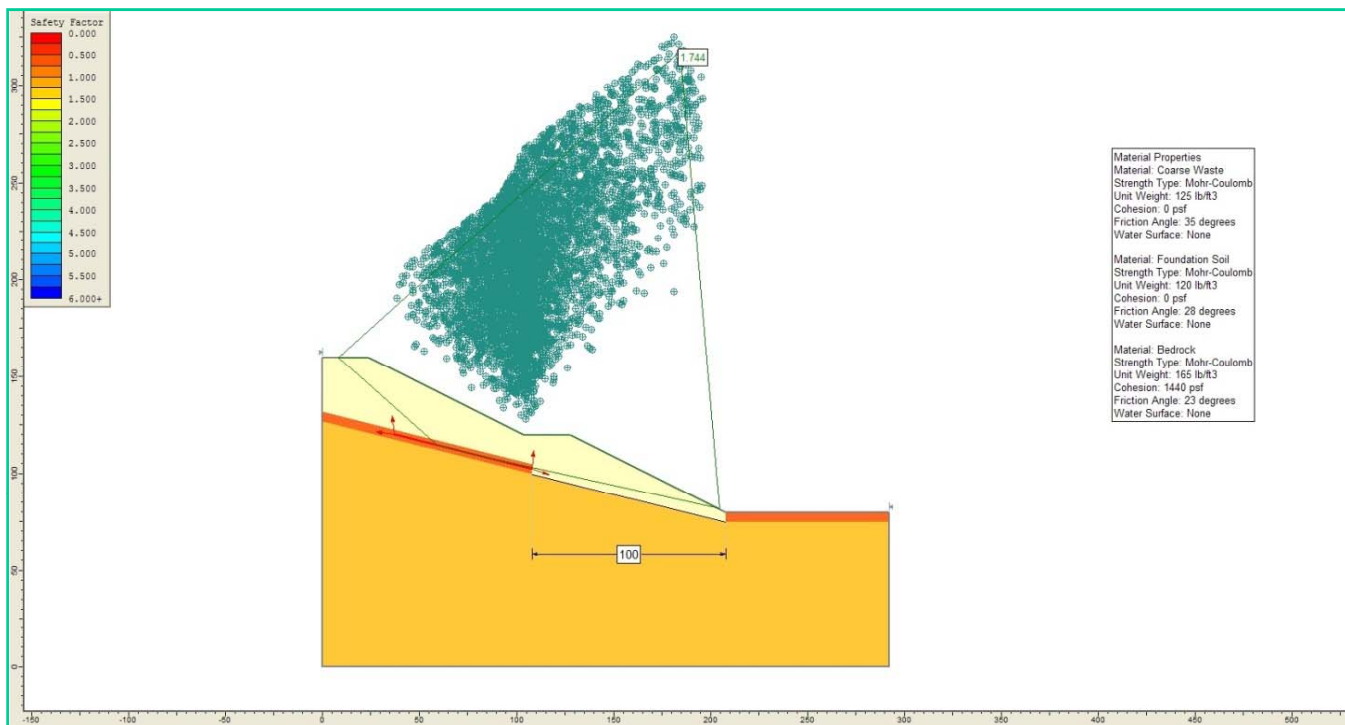
APPENDIX C8
 EMSA STABILITY REVIEW
 PERMANENTE QUARRY, CALIFORNIA
 SENSITIVITY STUDY - VARIATION OF
 SUBGRADE (5H:1V)



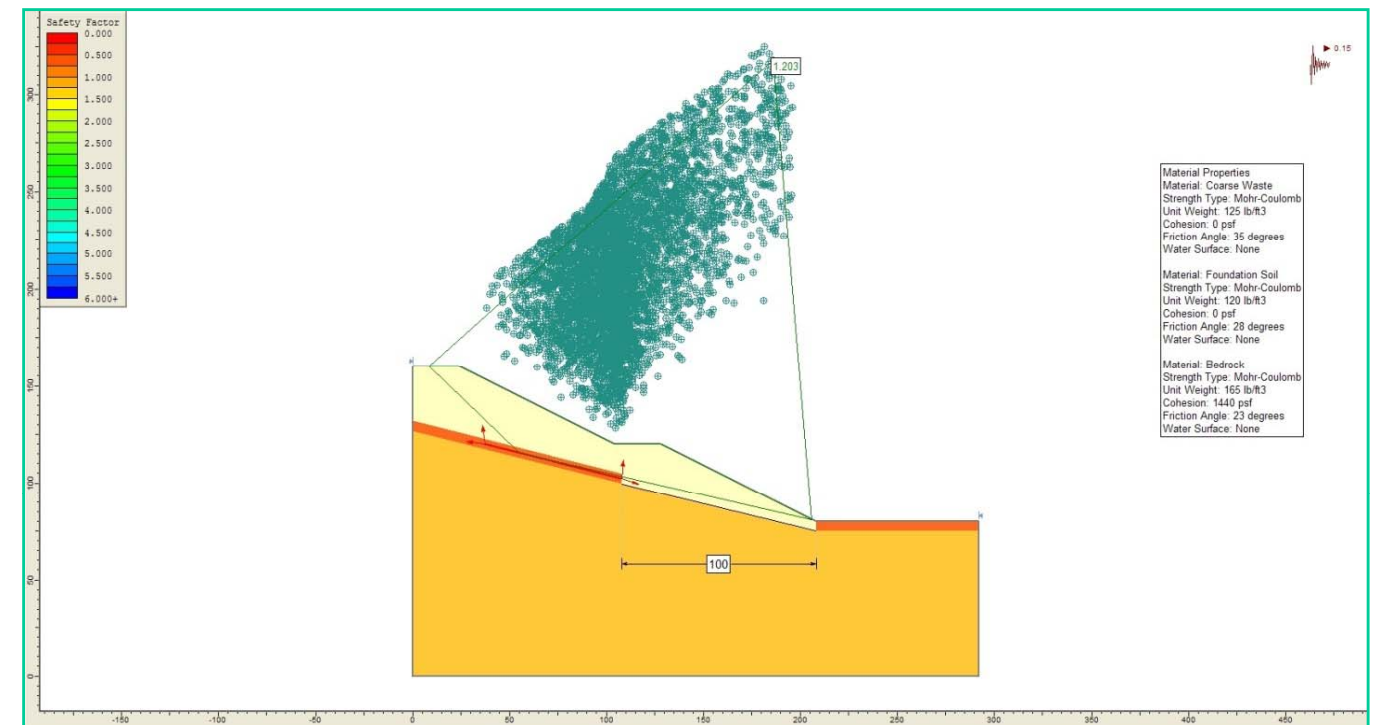
**CONCEPTUAL MODEL OF UNPREPARED SUBGRADE – STATIC
 LOCAL BLOCK FAILURE THROUGH FOUNDATION SOIL (4H:1V)
 (FOS = 1.32)**



**CONCEPTUAL MODEL OF UNPREPARED SUBGRADE – PSEUDO-STATIC
 LOCAL BLOCK FAILURE THROUGH FOUNDATION SOIL (4H:1V)
 (FOS = 0.96)**



**CONCEPTUAL MODEL OF PREPARED SUBGRADE – STATIC
 LOCAL BLOCK FAILURE THROUGH FOUNDATION SOIL (4H:1V)
 (FOS = 1.74)**



**CONCEPTUAL MODEL OF UNPREPARED SUBGRADE – PSEUDO-STATIC
 LOCAL BLOCK FAILURE THROUGH FOUNDATION SOIL (4H:1V)
 (FOS = 1.20)**



APPENDIX C9
 EMSA STABILITY REVIEW
 PERMANENTE QUARRY, CALIFORNIA
 SENSITIVITY STUDY - VARIATION OF
 SUBGRADE (4H:1V)

Attachment F
Drainage Report

June 12, 2009

Mr. Ryan Fong
Land Development Engineering
County of Santa Clara
70 West Hedding Street
San Jose, CA 95110-1705

Subject: Permanente Quarry Reclamation Plan Amendment, File No. 2250-13-66-09P

Dear Mr. Fong:

This letter responds to Comment No. 5 from the County of Santa Clara's May 20, 2009 letter regarding Chang Consultants' April 14, 2009, *Drainage Report for Permanente Quarry East Materials Storage Area*. The hydrologic analyses in the report were performed using the Rational Method procedure. I believe this in accordance with Santa Clara County's 2007 *Drainage Manual* criteria. Table 2.2 in the Manual indicates that the Rational Method may be used for drainage areas 200 acres or less in size as long as the project does not require the Santa Clara Valley Water District approval and meets three criteria. The project's overall watershed area is 122.8 acres and the project does not require SCVWD approval. The following discusses the three criteria.

The first criteria is that "no detention is being used." The drainage report indicates that the project will not increase the overall flow rates from the site. This occurs because the project will maintain the general flow patterns and not add impervious areas. Therefore, detention basins are not required nor proposed. On the other hand, a series of desiltation basins is being used for water quality purposes only. The outlet facilities in the desiltation basins have been sized to convey the full (undetained) 100-year flow rates. The basins are temporary and will be removed once the vegetation in the EMSA is established. The proposed condition Rational Method analyses are based on the final post-reclamation condition with the temporary basins removed.

The second criteria is that there are "no substantial surface storage effects." The EMSA has been designed with sloping terraces, sloping pads, sloping benches as well as a series of drainage ditches and swales. The EMSA does not propose level areas or surface depressions that can store or pond water. As a result, the EMSA will not contain substantial surface storage effects.

The third criteria is that there are "no large areas of pervious soils." The text in Section 2.4.1 of the Manual states that this condition only applies if there are "widely varying soil types." The current soils at the EMSA and adjacent quarry are uniformly classified as loam (hydrologic soil group B) by the Soil Texture exhibit in Appendix A. The soils placed in the EMSA will only be

from on-site sources and the upper layer of the EMSA will be capped with uniform material. Therefore, the EMSA will not contain widely varying soils under current or future conditions.

Comment 5 also requests that the basins be sized per Section 6.3.3 of the Manual or the 20-year storm. Section 6.3.3 governs sizing of detention basins. As indicated above, the basins are intended for desiltation purposes only so Section 6.3.3 was not used. The drainage report indicates that the basins were sized using the more conservative of two water quality criteria. The first is the volume-based sizing from the *C.3. Stormwater Handbook*. As we discussed, this criteria is more focused on projects that create impervious surfaces, and the results for the project do not yield large volume requirements since the project is essentially a large pervious area. Consequently, a procedure from the State Water Resources Control Board was also used. The analyses using this procedure were based on a 25-year event, which exceeds the 20-year event requested in Comment 5.

In summary, the analyses and project design meet the requirements in Comment 5. The project falls within the conditions under which the Rational Method should be used. The temporary desiltation basins have been designed using criteria based on a 25-year storm event. Please feel free to contact me with any questions.

Sincerely,

A handwritten signature in black ink, appearing to read 'Wayne W. Chang', with a stylized flourish at the end.

Wayne W. Chang, M.S., P.E.

DRAINAGE REPORT
FOR
PERMANENTE QUARRY
EAST MATERIALS STORAGE AREA

April 14, 2009

Wayne W. Chang, MS, PE 46548

ChangConsultants

Civil Engineering • Hydrology • Hydraulics • Sedimentation

P.O. Box 9496
Rancho Santa Fe, CA 92067
(858) 692-0760

FOR REVIEW ONLY

TABLE OF CONTENTS

Introduction.....	1
Hydrologic Analyses.....	2
Hydraulic Analyses.....	4
Desiltation Basin Analyses	4
Conclusion	6

APPENDICES

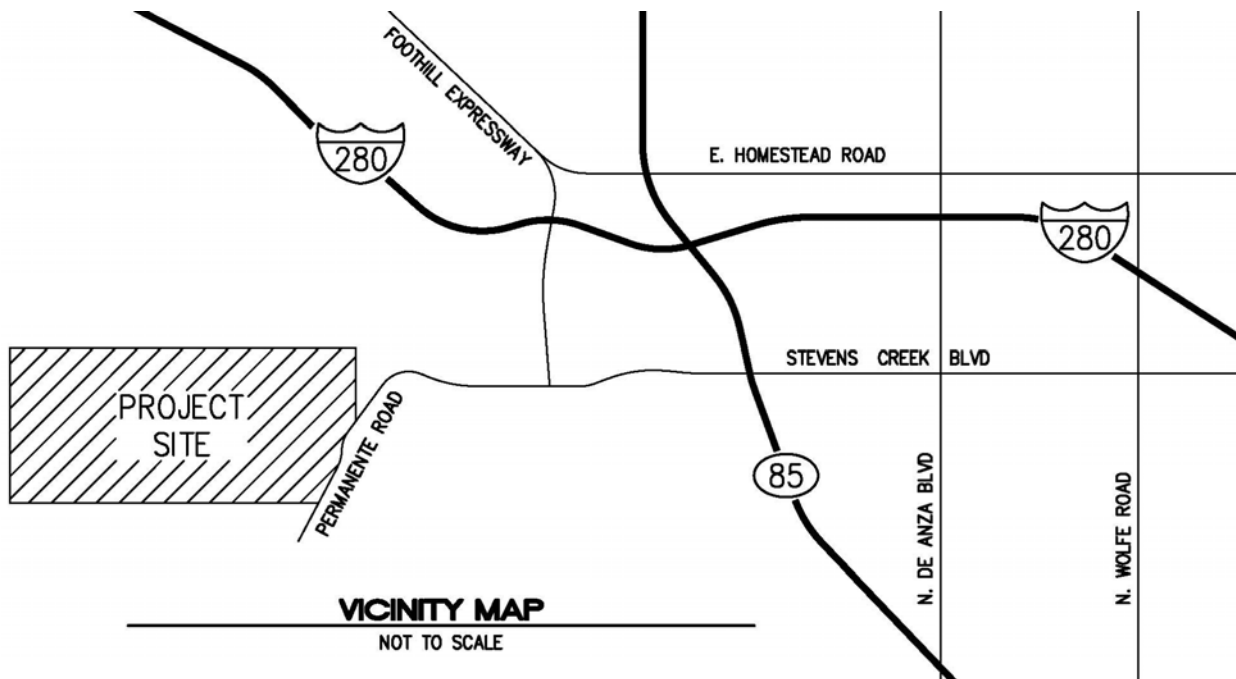
- A. Hydrologic Input Data and Analyses
- B. Desiltation Basin Analyses

MAP POCKET

Existing and Proposed Condition Rational Method Work Maps

INTRODUCTION

Lehigh Southwest Cement Co. operates the Permanente Quarry, which is located west of the city of Cupertino in Santa Clara County (see the Vicinity Map). Quarrying operations have occurred at the site since the early 1900's. A Reclamation Plan Amendment is now being proposed for a portion of the site known as the East Materials Storage Area (EMSA). This report has been prepared for the proposed activities in the EMSA. The EMSA is a large fill area primarily used for storing overburden material. The EMSA will generally be reclaimed with 2 to 1 (horizontal to vertical) inter-bench slopes (approximately 2.6 to 1 slope overall), and be constructed from an elevation of just over 550 feet to just over 900 feet. Benches will lie at approximately 40-foot vertical intervals, and a perimeter road will be graded around the EMSA. A series of drainage ditches and swales will serve the EMSA. The EMSA slopes will be reclaimed with native grasses and shrubs. The north and east facing benches will also contain trees (oaks), while the south facing benches will contain some pines. The uppermost pad area will be planted with grasses, shrubs, and some trees (pines).



This report contains drainage analyses of the pre- and post-reclamation flow rates from the EMSA and its tributary area. Santa Clara County's 2007 *Drainage Manual* indicates that new storm drain systems and channels shall be designed to convey the 10-year storm without surcharge, and a safe release shall be provided for the 100-year flow. Furthermore, the Surface Mining and Reclamation Act (SMARA) states that erosion control methods shall be designed for the 20-year storm, and shall control erosion and sedimentation during operations in the EMSA as well as after reclamation is complete in the EMSA (see *California Code of Regulations*, Title 14, Section 3706). The *Drainage Manual* provides parameters for the 25-year storm event, but not the 20-year event. The 25-year event was analyzed in this report in order to satisfy the

requirements for the 10- and 20-year events. Since the 25-year event is greater than these two events, the 25-year results will provide a greater factor-of-safety in the drainage design. The 100-year event was also analyzed in accordance with the *Drainage Manual* criteria.

Furthermore, this report contains analyses for several temporary desiltation basins that will be constructed around the EMSA perimeter. The basins, as well as other interim erosion control measures, will be used until the vegetation establishes. The desiltation basins have been sized according to criteria from the State Water Resources Control Board (SWRCB) and the Santa Clara Valley Urban Runoff Pollution Prevention Program (SCVURPPP).

HYDROLOGIC ANALYSES

Hydrologic analyses were performed for the existing and proposed reclaimed conditions. The Santa Clara County 2007 *Drainage Manual* rational method procedure was used for the 25- and 100-year hydrologic analyses. The rational method input parameters are summarized below and the supporting data is included in Appendix A:

- Rainfall Intensity: The 25- and 100-year intensity-duration-frequency curves were established using the Return Period-Duration-Specific (TDS) Regional Equation. The mean annual precipitation used in the TDS equation is 22 inches.
- Drainage area: The existing and proposed condition drainage basins were delineated from either the 10-foot contour interval base topography prepared for the EMSA (flown in 2008) or the proposed reclamation plan grading representing the ultimate EMSA configuration. The Rational Method Work Maps in the map pocket at the back of this report contain the existing topography, proposed grading, basin boundaries, rational method node numbers, and basin areas. The overall existing condition drainage basin boundary was set equal to the overall proposed condition boundary to allow a comparison of results.
- Hydrologic soil groups: The hydrologic soil group was determined from “Figure 1, Soil Texture and Mean Annual Precipitation Depths for the Santa Clara Basin” in SCVURPPP’s May 2004, C.3. *Stormwater Handbook*. The soil type at the site is entirely within group B.
- Runoff coefficients: The existing and proposed site conditions will contain negligible impervious surfaces. For existing conditions, the undisturbed areas were assigned a runoff coefficient associated with shrub land ($C = 0.10$ for soil group B). In addition, the existing condition disturbed surfaces were assigned a coefficient associated with the agricultural land use category ($C = 0.15$ for soil group B) because this represents an undeveloped condition with less transpiration. Under proposed conditions, nearly the entire area was assigned a runoff coefficient based on shrub land since the EMSA will be vegetated with grasses, shrubs, and trees.
- Flow lengths and elevations: The flow lengths and elevations were obtained from the topographic mapping and reclamation plan. The initial time of concentration was calculated using a spreadsheet based on the Kirpich equation from the *Drainage Manual*.

The rational method analyses were performed using the CivilDesign Universal Rational Method Hydrology Program. This program was customized to meet the Santa Clara County hydrologic criteria. The County’s intensity-duration data was input into the program. The times of concentration for initial subareas were calculated using a spreadsheet of the Kirpich equation, which is included in Appendix A. The initial time of concentration values from the spreadsheet were entered as user-specified data in the program. After the initial subarea is modeled, the program can route the flow in channels, streets, pipes, etc. The channel routing routine was used to model the flow in natural drainages and proposed ditches. The program also allows for flow in separate streams to be confluenced.

The runoff coefficients for each subarea were based on an area average weighting and developed using a spreadsheet, which is included in Appendix A. The program requires a land use to be entered (e.g., undeveloped dense cover, undeveloped average cover, etc.). However, the runoff coefficients used by the program were based on user-defined values, rather than the specified land use and soil group. Therefore, while the land uses listed in the output provide a general description of the land use, they were not used for determination of the runoff coefficients.

The 25- and 100-year existing and proposed condition rational method output from the program are included in Appendix A and summarized in Table 1. The existing and proposed condition study areas were subdivided into four major drainage basins (10, 20, 30, and 40 for existing conditions; and 100, 200, 300, 400 for proposed conditions). The major basins also include smaller subareas (see the Rational Method Work Maps in the map pocket – the Proposed Condition Rational Method Work Map also contains seven temporary desiltation basins that are discussed later in this report and labeled 30A, 30B, 30C, 30D, 30E, 31B and 31C). The rational method node numbering is based on the major basin number. For instance, rational method nodes 10, 11, 12, etc. are in Major Basin 10; nodes 200, 201, 202, etc. are in Major Basin 200; and so on. Existing condition Major Basin 10 corresponds to proposed condition Major Basin 100, etc. Major Basins 10 and 100 outlet along the southerly portion of the EMSA. The runoff from these basins flows through the plant and ultimately into Permanente Creek. Major Basins 20 and 200 outlet towards the easterly portion of the EMSA and flow a short distance to Permanente Creek. Major Basins 30, 40, 300, and 400 outlet along the northerly portion of the EMSA into natural canyons.

Existing Condition			Proposed Condition		
Major Drainage Basin	25-Year Flow, cfs	100-Year Flow, cfs	Major Drainage Basin	25-Year Flow, cfs	100-Year Flow, cfs
10	13	16	100	11	14
20	9	11	200	8	10
30	0.6	0.7	300	0.6	0.7
40	0.5	0.6	400	0.6	0.8

Table 1. Summary of Rational Method Results

The Rational Method results indicate that reclamation at the proposed project will slightly reduce the 100-year runoff from the first three major basins. On the other hand, there will be a very

minor increase of 0.1 cubic feet per second (cfs) during the 25-year storm and 0.2 cfs during the 100-year storm from Major Basin 400. These increases are so minor that they are considered to be negligible and will not cause adverse impacts. Riprap pads will be installed at the discharge points from Major Basin 400 to provide a safe release in accordance with the *Drainage Manual* criteria. These results indicate that reclamation will control erosion and sedimentation in compliance with SMARA's standards. Reclamation will also satisfy the drainage criteria of Santa Clara County.

HYDRAULIC ANALYSES

A series of drainage ditches (or swales) will be installed along the inside edge of the benches and perimeter road. The EMSA drawings propose a semi-circular ditch that is 3-feet wide and 1.5-foot deep along the benches, and a semi-circular ditch that is 4-feet wide and 2-feet deep along the perimeter road. The ditches along the perimeter road should be lined with grouted riprap or an equivalent material to prevent erosion. Normal depth analyses were performed to verify the capacity of the ditches. The largest proposed condition 100-year flow rate in the bench ditches will be approximately 5.5 cfs (near Rational Method Node 205). A normal depth analysis is included after this report text and shows that the ditches are capable of conveying this flow rate at a normal depth of approximately 1.0 feet. This is based on the minimum ditch longitudinal slope of 1 percent. The largest proposed condition 100-year flow rate in the perimeter road ditches is 14 cfs. The normal depth analysis shows that the ditches can convey this flow rate at a normal depth of 1.7 feet. Therefore, the perimeter road ditches can convey the required flow rate without surcharge. Furthermore, the benches and perimeter road are proposed with a cross-slope of 2 percent towards the ditches, which provides for additional flow conveyance capacity and freeboard.

DESILTATION BASIN ANALYSES

The primary water quality pollutant generated from the EMSA will be sediment since the site will be used to store overburden material. The EMSA slopes, benches, and pads will be planted with grasses, shrubs, and trees to prevent erosion. In the interim period before the vegetation has established, best management practices including desiltation basins will be installed. The temporary desiltation basins will be constructed at several locations along the perimeter of the EMSA to capture sediment. The Proposed Condition Rational Method Work Map contains the seven temporary desiltation basins, which are labeled 30A, 30B, 30C, 30D, 30E, 31B and 31C. Two methodologies have been considered for sizing the desiltation basins. First, SCVURPPP outlines volume-based treatment control sizing in their *C.3. Stormwater Handbook*. Second, the State Water Resources Control Board (SWRCB) *Water Quality Order 99-08-DWQ* provides sediment basin sizing criteria.

The SCVURPPP's preferred method for sizing volume-based treatment controls is to use the California Stormwater BMP Handbook approach, which is included in the *C.3. Stormwater Handbook*. An analysis using this approach is given in Appendix B for the largest area tributary to a desiltation basin. The results yield a required storage volume of 3,404 cubic feet.

The SWRCB procedure is recommended for construction sites with exposed surfaces, which is appropriate for the EMSA. Their procedure is based on the equation:

$$A_s = 1.2Q / V_s$$

where A_s is the minimum surface area for trapping soil particles of a certain size, sf
 Q is the discharge, cfs
 V_s is the settling velocity, fps

The SWRCB recommends that Q be based on the 10-year event. However, the 25-year event was used in order to meet the Surface Mining and Reclamation Act's 20-year event requirement for erosion control. A particle size distribution was provided by Golder Associates, Inc. that generally represents the waste rock that will be stored in the EMSA. The distribution is included in Appendix B and shows that nearly 93 percent of the material will be larger than 0.074 mm (No. 200 sieve size). Sediment smaller than the No. 200 sieve typically occur in suspension and are less prone to settling. The Regional Water Quality Control Board, San Francisco Bay Region's *Erosion and Sediment Control Field Manual* provides settling velocities for several particle sizes. The settling velocity for a particle size of 0.05 mm (0.0062 feet per second) was selected because this size is smaller than 0.074 mm. A spreadsheet was created for the SWRCB equation and is included in Appendix B.

The desiltation basins were sized to exceed the volume from the SCVURPPP equation and the surface area from the SWRCB equation. The SWRCB recommends that the basin length be twice the width, and the storage depth be between 3 to 5 feet. The desiltation basins also meet these criteria as applied to the calculated volume and surface area. The desiltation basins shown on the EMSA plans typically exceed the calculated values by a significant amount.

The outlet works for the desiltation basins were designed to pass the 100-year flow rates. The outlet works consist of a minimum 24-inch riser connected to an outflow pipe and an emergency spillway. Water that exits through the riser will initially behave as weir flow. As the water continues to rise above the riser it will behave as orifice flow. Both weir and orifice analyses were performed for the riser to account for either condition. The analyses were based on the maximum proposed condition 100-year flow rate into a desiltation basin (13.6 cfs) and are included in Appendix B. The analyses show that the 100-year flow can pond up to 0.8 feet above the riser. Consequently, the emergency spillway was set 1-foot above the top of riser. A broad-crested weir analysis was used to size an emergency spillway that can convey the maximum 100-year flow rate. The analysis is included in Appendix B and shows that a weir with a 10-foot width can convey the flow at a 0.6 foot depth. Finally, a normal depth analysis was performed to verify the capacity of the 24-inch pipe that conveys flow from the riser out of a desiltation basin. The analysis shows that the pipe can convey the maximum 100-year flow rate with a normal depth of 1.1 feet. The riprap at the pipe outlet has been sized based on the outflow velocity.

CONCLUSION

Drainage analyses have been performed for the East Materials Storage Area proposed at the Permanente Quarry. The EMSA will be used to store overburden material and will ultimately be planted with native materials. There are no impervious areas proposed at the EMSA. As a result, the proposed reclamation will have a low runoff potential and will result in a slight overall reduction in flow rates. Temporary best management practices will be used at the site until the vegetation is established. The BMPs include desiltation basins, which have been sized with a greater capacity than required by the SCVURPPP and SWRCB guidelines. As a result, the EMSA has been designed for both the required design and water quality flow rates, and meets SMARA's standards (*California Code of Regulations*, Title 14, Section 3706) for erosion and sediment control.

Worksheet for Ditch on Benches

Project Description

Friction Method	Manning Formula
Solve For	Normal Depth

Input Data

Roughness Coefficient	0.030	
Channel Slope	0.01000	ft/ft
Constructed Depth	1.50	ft
Constructed Top Width	3.00	ft
Discharge	5.50	ft ³ /s

Results

Normal Depth	1.04	ft
Flow Area	1.74	ft ²
Wetted Perimeter	3.39	ft
Hydraulic Radius	0.51	ft
Top Width	2.50	ft
Critical Depth	0.85	ft
Critical Slope	0.02225	ft/ft
Velocity	3.17	ft/s
Velocity Head	0.16	ft
Specific Energy	1.20	ft
Froude Number	0.67	
Flow Type	Subcritical	

GVF Input Data

Downstream Depth	0.00	ft
Length	0.00	ft
Number Of Steps	0	

GVF Output Data

Upstream Depth	0.00	ft
Profile Description		
Profile Headloss	0.00	ft
Downstream Velocity	Infinity	ft/s
Upstream Velocity	Infinity	ft/s
Normal Depth	1.04	ft
Critical Depth	0.85	ft
Channel Slope	0.01000	ft/ft
Critical Slope	0.02225	ft/ft

Worksheet for Ditch on Perimeter Road

Project Description

Friction Method	Manning Formula
Solve For	Normal Depth

Input Data

Roughness Coefficient	0.040	
Channel Slope	0.01000	ft/ft
Constructed Depth	2.00	ft
Constructed Top Width	4.00	ft
Discharge	14.00	ft ³ /s

Results

Normal Depth	1.74	ft
Flow Area	4.33	ft ²
Wetted Perimeter	5.33	ft
Hydraulic Radius	0.81	ft
Top Width	3.73	ft
Critical Depth	1.27	ft
Critical Slope	0.03571	ft/ft
Velocity	3.23	ft/s
Velocity Head	0.16	ft
Specific Energy	1.90	ft
Froude Number	0.53	
Flow Type	Subcritical	

GVF Input Data

Downstream Depth	0.00	ft
Length	0.00	ft
Number Of Steps	0	

GVF Output Data

Upstream Depth	0.00	ft
Profile Description		
Profile Headloss	0.00	ft
Downstream Velocity	Infinity	ft/s
Upstream Velocity	Infinity	ft/s
Normal Depth	1.74	ft
Critical Depth	1.27	ft
Channel Slope	0.01000	ft/ft
Critical Slope	0.03571	ft/ft

APPENDIX A

HYDROLOGIC INPUT DATA AND ANALYSES

RATIONAL METHOD INPUT DATA

25-Year Return Period

Duration	A	B	MAP, in	x, in	I, in/hr
5	0.230641	0.002691	22	0.2898	3.478
10	0.287566	0.004930	22	0.3960	2.376
15	0.348021	0.005594	22	0.4711	1.884
30	0.443761	0.008719	22	0.6356	1.271
60	0.508791	0.016680	22	0.8758	0.876
120	0.612629	0.031025	22	1.2952	0.648
180	0.689252	0.044264	22	1.6631	0.554
360	0.693566	0.083195	22	2.5239	0.421

100-Year Return Period

Duration	A	B	MAP, in	x, in	I, in/hr
5	0.269993	0.003580	22	0.3488	4.185
10	0.315263	0.007312	22	0.4761	2.857
15	0.421360	0.006957	22	0.5744	2.298
30	0.553934	0.009857	22	0.7708	1.542
60	0.626608	0.019201	22	1.0490	1.049
120	0.732944	0.036193	22	1.5292	0.765
180	0.816471	0.051981	22	1.9601	0.653
360	0.776677	0.101053	22	2.9998	0.500

Kirpich Equation for Initial Subareas

Nodes	Up Elev., ft	Down Elev., ft	L, feet	S, ft/ft	Tc, min
10-11	1,355	1,050	919	0.33	12.3
20-21	1,074	890	581	0.32	11.6
30-31	1,012	880	634	0.21	12.1
40-41	754	694	442	0.14	11.8
110-111	777	725	140	0.37	10.5
200-201	1,074	904	581	0.29	11.7
210-211	860	856	443	0.01	15.0
220-221	645	636	919	0.01	18.9
300-301	1015	900	758	0.15	12.7
400-401	815	700	938	0.12	13.4
401-402	705	686	631	0.03	14.3

RATIONAL METHOD INPUT DATA

Existing Condition Runoff Coefficients (Soil Type B)

Nodes	% Shrub Land	% Agriculture	C
10-11	100	--	0.10
11-12	100	--	0.10
12-13	65	35	0.12
13-14	10	90	0.15
20-21	100	--	0.10
21-22	60	40	0.12
22-23	40	60	0.13
23-24	70	30	0.12
30-31	100	--	0.10
31-32	100	--	0.10
40-41	100	--	0.10

Proposed Condition Runoff Coefficients (Soil Type B)

Nodes	% Shrub Land	% Agriculture	C
102-103	65	35	0.12
All Others	100	--	0.10

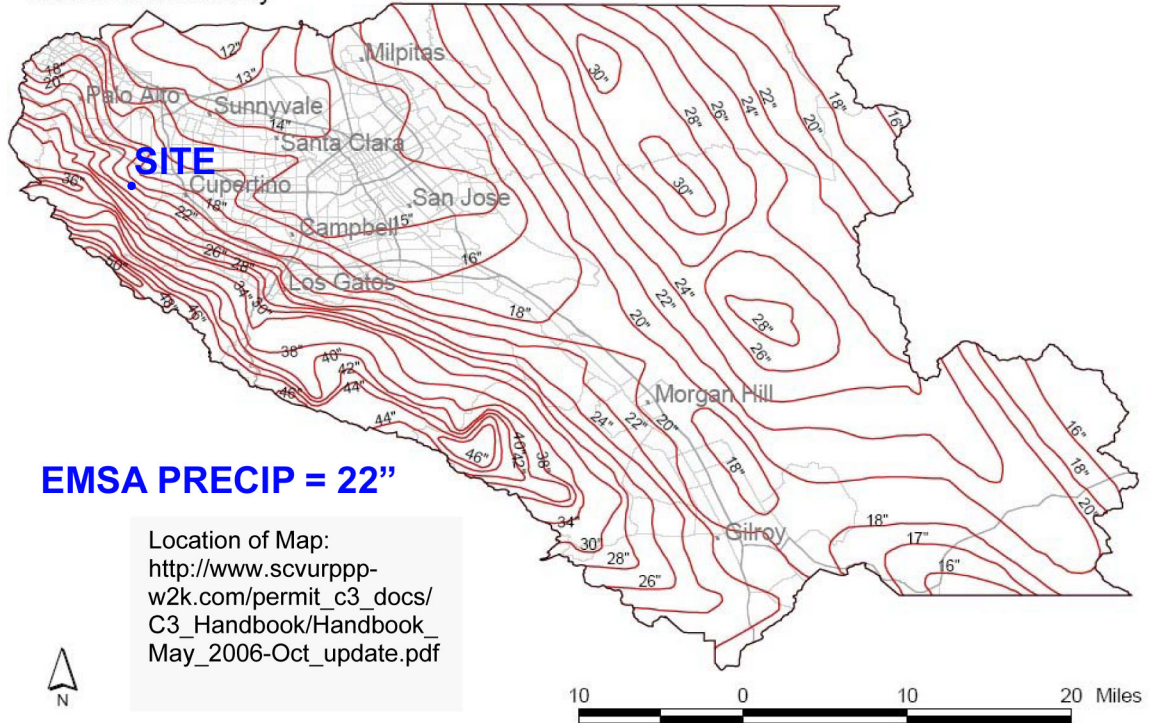


Table B-2: Parameters $A_{T,D}$ and $B_{T,D}$ for TDS Equation

Return Period/Duration	$A_{T,D}$	$B_{T,D}$
25-YR RETURN PERIOD		
5-min	0.230641	0.002691
10-min	0.287566	0.004930
15-min	0.348021	0.005594
30-min	0.443761	0.008719
1-hr	0.508791	0.016680
2-hr	0.612629	0.031025
3-hr	0.689252	0.044264
6-hr	0.693566	0.083195
12-hr	0.725892	0.132326
24-hr	0.675008	0.195496
48-hr	0.989588	0.264703
72-hr	0.967854	0.316424
50-YR RETURN PERIOD		
5-min	0.249324	0.003241
10-min	0.300971	0.006161
15-min	0.384016	0.006315
30-min	0.496301	0.009417
1-hr	0.568345	0.017953
2-hr	0.672662	0.033694
3-hr	0.754661	0.048157
6-hr	0.740666	0.092105
12-hr	0.779967	0.147303
24-hr	0.747121	0.219673
48-hr	1.108358	0.295510
72-hr	1.075643	0.353143
100-YR RETURN PERIOD		
5-min	0.269993	0.003580
10-min	0.315263	0.007312
15-min	0.421360	0.006957
30-min	0.553934	0.009857
1-hr	0.626608	0.019201
2-hr	0.732944	0.036193
3-hr	0.816471	0.051981
6-hr	0.776677	0.101053
12-hr	0.821859	0.162184
24-hr	0.814046	0.243391
48-hr	1.210895	0.325943
72-hr	1.175000	0.389038

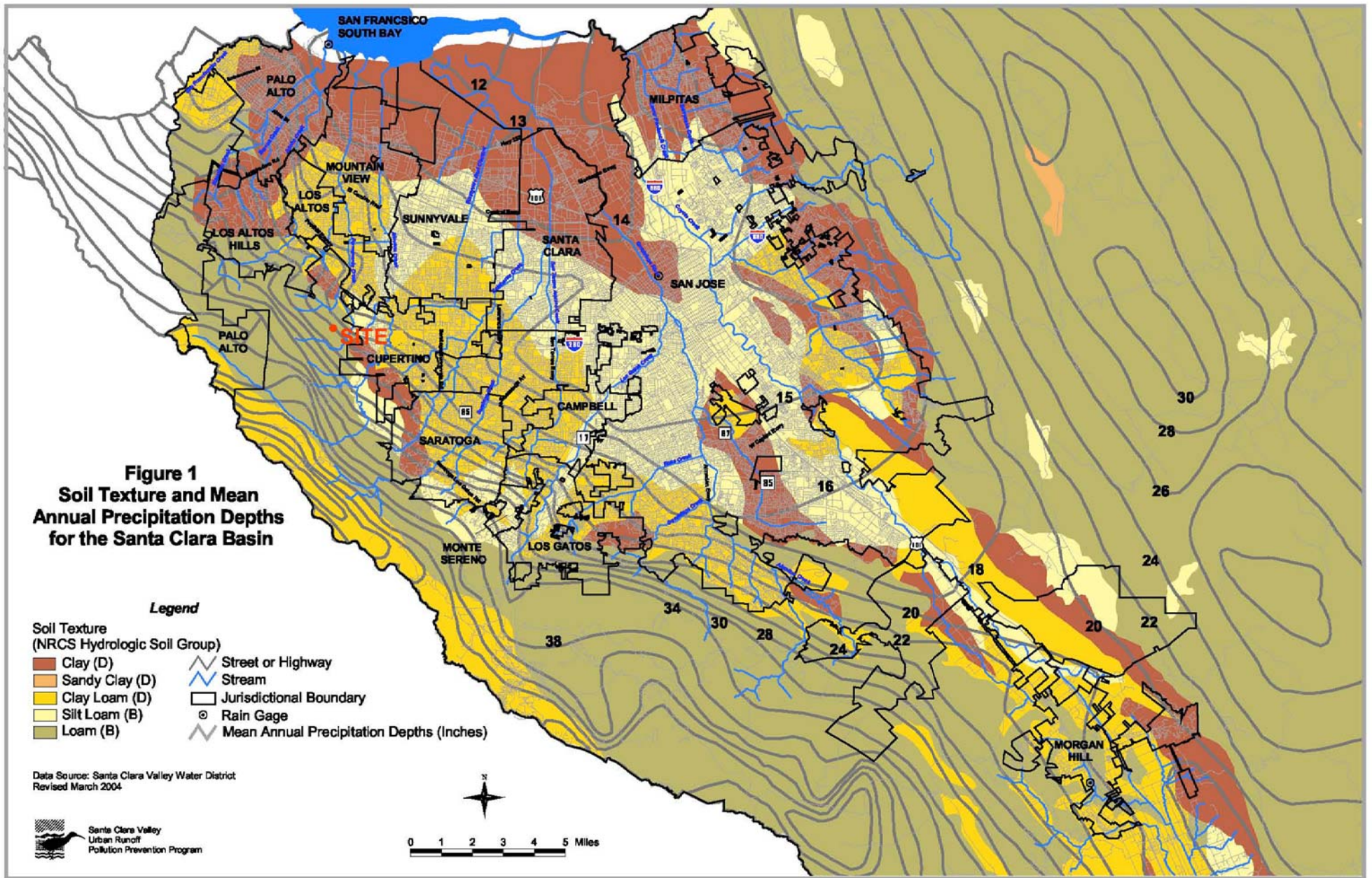


Figure A-2
Mean Annual Precipitation Map
Santa Clara County



SOURCE: Santa Clara Valley Water District, Mean Annual Precipitation Map, San Francisco & Monterey Bay Region, 1998

Figure A-2: Mean Annual Precipitation, Santa Clara County





In Table 3-1 Soil Types B, C and D are based on the SCS classification of HSG. This designation is a standard designation used by the SCS and has been defined for Santa Clara County in existing SCS publications. D-type soils are less permeable than are C-type soils, which are, in turn, less permeable than B-type soils.

Table 3-1: Runoff Coefficients for Rational Formula

Land Use	C for Soil Type		
	B	C	D
Low Density Residential	0.30	0.40	0.45
Medium Density Residential	0.50	0.55	0.60
High Density Residential	0.70	0.70	0.75
Commercial	0.80	0.80	0.80
Industrial	0.70	0.75	0.75
Parks	0.20	0.30	0.35
Agricultural	0.15	0.35	0.40
Urban Open Space	0.10	0.35	0.45
Shrub Land	0.10	0.20	0.30
Paved / Impervious Surface	0.85	0.85	0.85

The Rational Method implies that this ratio is fixed for a given drainage basin. Studies have shown, however, that the coefficient may vary with respect to prior wetting and seasonal conditions (antecedent moisture). It has also been observed that as rainfall intensity increases, soil permeability decreases. One may sense that runoff coefficients should increase with rainfall intensity.

Applying such non-linearities over relatively small urbanized drainage basins does not necessarily improve hydrologic precision enough to offset the more difficult computations, so using a constant runoff coefficient is standard in Santa Clara County. For watersheds with significant variation in antecedent moisture conditions, soil types, or other complexities, however; the hydrograph method described in Chapter 4 should be employed regardless of basin size.

UNIVERSAL RATIONAL METHOD HYDROLOGY PROGRAM

CIVILCADD/CIVILDESIGN Engineering Software, (c) 1989- 2005 Version 7.1
Rational Hydrology Study Date: 03/21/09

EMSA

Existing Conditions

25-Year Flow Rate

County of Santa Clara Rational Method

***** Hydrology Study Control Information *****

Program License Serial Number 4028

Rational hydrology study storm event year is 25.0

Number of [time,intensity] data pairs = 8

No.	Time	-	Intensity
1	5.000		3.478(In.)
2	10.000		2.376(In.)
3	15.000		1.884(In.)
4	30.000		1.271(In.)
5	60.000		0.876(In.)
6	120.000		0.648(In.)
7	180.000		0.554(In.)
8	360.000		0.421(In.)

English Input Units Used

English Output Units Used:

Area = acres, Distance = feet, Flow q = ft³/s, Pipe diam. = inches

Runoff coefficient method used:

Runoff coefficient 'C' value calculated for the
equation $Q=KCIA$ [K=unit constant(1 if English Units, 1/360 if SI Units),
I=rainfall intensity, A=area];

by the following method:

Manual entry of 'C' values

Rational Hydrology Method used:

The rational hydrology method is used where the area
of each subarea in a stream, subarea 'C' value, and rain-
fall intensity for each subarea is used to determine the
subarea flow rate q, of which values are summed for total Q

Stream flow confluence option used:

Stream flow confluence method of 2 - 5 streams:

Note: in all cases, if the time of concentration

or TC of all streams are identical, then $q = \text{sum of stream flows}$

Variables p=peak; i=intensity; Fm=loss rate; a=area; 1...n flows

$q = \text{flow rate, } t = \text{time in minutes}$

Stream flows summed; $qp = q1 + q2 + \dots + qn$

TC = t of stream with largest q

+++++
Process from Point/Station 10.000 to Point/Station 11.000
**** INITIAL AREA EVALUATION ****

UNDEVELOPED (dense cover) subarea
Initial subarea data:
Equations shown use english units, converted if necessary to (SI)
Initial area flow distance = 919.000(Ft.)
Top (of initial area) elevation = 1355.000(Ft.)
Bottom (of initial area) elevation = 1050.000(Ft.)
Difference in elevation = 305.000(Ft.)
Slope = 0.33188 s(%)= 33.19
Manual entry of initial area time of concentration, TC
Initial area time of concentration = 12.300 min.
Rainfall intensity = 2.150(In/Hr) for a 25.0 year storm
Effective runoff coefficient used for area (Q=KCIA) is C = 0.100
Subarea runoff = 1.281(CFS)
Total initial stream area = 5.960(Ac.)

+++++
Process from Point/Station 11.000 to Point/Station 12.000
**** IMPROVED CHANNEL TRAVEL TIME ****

Upstream point elevation = 1050.000(Ft.)
Downstream point elevation = 920.000(Ft.)
Channel length thru subarea = 587.000(Ft.)
Channel base width = 10.000(Ft.)
Slope or 'Z' of left channel bank = 2.000
Slope or 'Z' of right channel bank = 2.000
Estimated mean flow rate at midpoint of channel = 2.645(CFS)
Manning's 'N' = 0.050
Maximum depth of channel = 5.000(Ft.)
Flow(q) thru subarea = 2.645(CFS)
Depth of flow = 0.092(Ft.), Average velocity = 2.814(Ft/s)
Channel flow top width = 10.369(Ft.)
Flow Velocity = 2.81(Ft/s)
Travel time = 3.48 min.
Time of concentration = 15.78 min.
Critical depth = 0.129(Ft.)
Adding area flow to channel
UNDEVELOPED (dense cover) subarea
Rainfall intensity = 1.852(In/Hr) for a 25.0 year storm
Subarea runoff = 2.351(CFS) for 12.690(Ac.)
Total runoff = 3.632(CFS) Total area = 18.650(Ac.)

+++++
Process from Point/Station 12.000 to Point/Station 13.000
**** IMPROVED CHANNEL TRAVEL TIME ****

Upstream point elevation = 920.000(Ft.)
Downstream point elevation = 850.000(Ft.)
Channel length thru subarea = 1040.000(Ft.)
Channel base width = 10.000(Ft.)

Slope or 'Z' of left channel bank = 10.000
 Slope or 'Z' of right channel bank = 10.000
 Estimated mean flow rate at midpoint of channel = 6.679(CFS)
 Manning's 'N' = 0.030
 Maximum depth of channel = 2.000(Ft.)
 Flow(q) thru subarea = 6.679(CFS)
 Depth of flow = 0.163(Ft.), Average velocity = 3.515(Ft/s)
 Channel flow top width = 13.267(Ft.)
 Flow Velocity = 3.52(Ft/s)
 Travel time = 4.93 min.
 Time of concentration = 20.71 min.
 Critical depth = 0.223(Ft.)
 Adding area flow to channel
 UNDEVELOPED (average cover) subarea
 Rainfall intensity = 1.651(In/Hr) for a 25.0 year storm
 Subarea runoff = 6.200(CFS) for 31.300(Ac.)
 Total runoff = 9.832(CFS) Total area = 49.950(Ac.)

++++++
 Process from Point/Station 13.000 to Point/Station 14.000
 **** IMPROVED CHANNEL TRAVEL TIME ****

Upstream point elevation = 850.000(Ft.)
 Downstream point elevation = 720.000(Ft.)
 Channel length thru subarea = 636.000(Ft.)
 Channel base width = 10.000(Ft.)
 Slope or 'Z' of left channel bank = 2.000
 Slope or 'Z' of right channel bank = 2.000
 Estimated mean flow rate at midpoint of channel = 11.130(CFS)
 Manning's 'N' = 0.030
 Maximum depth of channel = 2.000(Ft.)
 Flow(q) thru subarea = 11.130(CFS)
 Depth of flow = 0.164(Ft.), Average velocity = 6.552(Ft/s)
 Channel flow top width = 10.658(Ft.)
 Flow Velocity = 6.55(Ft/s)
 Travel time = 1.62 min.
 Time of concentration = 22.33 min.
 Critical depth = 0.328(Ft.)
 Adding area flow to channel
 UNDEVELOPED (poor cover) subarea
 Rainfall intensity = 1.585(In/Hr) for a 25.0 year storm
 Subarea runoff = 3.135(CFS) for 13.190(Ac.)
 Total runoff = 12.967(CFS) Total area = 63.140(Ac.)

++++++
 Process from Point/Station 13.000 to Point/Station 14.000
 **** CONFLUENCE OF MAIN STREAMS ****

The following data inside Main Stream is listed:
 In Main Stream number: 1
 Stream flow area = 63.140(Ac.)
 Runoff from this stream = 12.967(CFS)
 Time of concentration = 22.33 min.
 Rainfall intensity = 1.585(In/Hr)
 Program is now starting with Main Stream No. 2

+++++
Process from Point/Station 20.000 to Point/Station 21.000
**** INITIAL AREA EVALUATION ****

UNDEVELOPED (dense cover) subarea
Initial subarea data:
Equations shown use english units, converted if necessary to (SI)
Initial area flow distance = 581.000(Ft.)
Top (of initial area) elevation = 1074.000(Ft.)
Bottom (of initial area) elevation = 890.000(Ft.)
Difference in elevation = 184.000(Ft.)
Slope = 0.31670 s(%)= 31.67
Manual entry of initial area time of concentration, TC
Initial area time of concentration = 11.600 min.
Rainfall intensity = 2.219(In/Hr) for a 25.0 year storm
Effective runoff coefficient used for area (Q=KCIA) is C = 0.100
Subarea runoff = 0.579(CFS)
Total initial stream area = 2.610(Ac.)

+++++
Process from Point/Station 21.000 to Point/Station 22.000
**** IMPROVED CHANNEL TRAVEL TIME ****

Upstream point elevation = 890.000(Ft.)
Downstream point elevation = 830.000(Ft.)
Channel length thru subarea = 1040.000(Ft.)
Channel base width = 10.000(Ft.)
Slope or 'Z' of left channel bank = 3.000
Slope or 'Z' of right channel bank = 3.000
Estimated mean flow rate at midpoint of channel = 1.494(CFS)
Manning's 'N' = 0.030
Maximum depth of channel = 2.000(Ft.)
Flow(q) thru subarea = 1.494(CFS)
Depth of flow = 0.072(Ft.), Average velocity = 2.029(Ft/s)
Channel flow top width = 10.432(Ft.)
Flow Velocity = 2.03(Ft/s)
Travel time = 8.54 min.
Time of concentration = 20.14 min.
Critical depth = 0.088(Ft.)
Adding area flow to channel

UNDEVELOPED (average cover) subarea
Rainfall intensity = 1.674(In/Hr) for a 25.0 year storm
Subarea runoff = 1.657(CFS) for 8.250(Ac.)
Total runoff = 2.236(CFS) Total area = 10.860(Ac.)

+++++
Process from Point/Station 22.000 to Point/Station 23.000
**** IMPROVED CHANNEL TRAVEL TIME ****

Upstream point elevation = 830.000(Ft.)
Downstream point elevation = 700.000(Ft.)
Channel length thru subarea = 1602.000(Ft.)
Channel base width = 10.000(Ft.)

Slope or 'Z' of left channel bank = 2.000
 Slope or 'Z' of right channel bank = 2.000
 Estimated mean flow rate at midpoint of channel = 3.142(CFS)
 Manning's 'N' = 0.030
 Maximum depth of channel = 2.000(Ft.)
 Flow(q) thru subarea = 3.142(CFS)
 Depth of flow = 0.102(Ft.), Average velocity = 3.026(Ft/s)
 Channel flow top width = 10.407(Ft.)
 Flow Velocity = 3.03(Ft/s)
 Travel time = 8.82 min.
 Time of concentration = 28.97 min.
 Critical depth = 0.145(Ft.)
 Adding area flow to channel
 UNDEVELOPED (poor cover) subarea
 Rainfall intensity = 1.313(In/Hr) for a 25.0 year storm
 Subarea runoff = 1.502(CFS) for 8.800(Ac.)
 Total runoff = 3.739(CFS) Total area = 19.660(Ac.)

++++++
 Process from Point/Station 23.000 to Point/Station 24.000
 **** IMPROVED CHANNEL TRAVEL TIME ****

Upstream point elevation = 700.000(Ft.)
 Downstream point elevation = 556.000(Ft.)
 Channel length thru subarea = 1910.000(Ft.)
 Channel base width = 10.000(Ft.)
 Slope or 'Z' of left channel bank = 2.000
 Slope or 'Z' of right channel bank = 2.000
 Estimated mean flow rate at midpoint of channel = 7.038(CFS)
 Manning's 'N' = 0.030
 Maximum depth of channel = 2.000(Ft.)
 Flow(q) thru subarea = 7.038(CFS)
 Depth of flow = 0.168(Ft.), Average velocity = 4.041(Ft/s)
 Channel flow top width = 10.674(Ft.)
 Flow Velocity = 4.04(Ft/s)
 Travel time = 7.88 min.
 Time of concentration = 36.84 min.
 Critical depth = 0.246(Ft.)
 Adding area flow to channel
 UNDEVELOPED (average cover) subarea
 Rainfall intensity = 1.181(In/Hr) for a 25.0 year storm
 Subarea runoff = 4.917(CFS) for 34.700(Ac.)
 Total runoff = 8.656(CFS) Total area = 54.360(Ac.)

++++++
 Process from Point/Station 23.000 to Point/Station 24.000
 **** CONFLUENCE OF MAIN STREAMS ****

The following data inside Main Stream is listed:
 In Main Stream number: 2
 Stream flow area = 54.360(Ac.)
 Runoff from this stream = 8.656(CFS)
 Time of concentration = 36.84 min.
 Rainfall intensity = 1.181(In/Hr)
 Program is now starting with Main Stream No. 3

+++++
Process from Point/Station 30.000 to Point/Station 31.000
**** INITIAL AREA EVALUATION ****

UNDEVELOPED (dense cover) subarea
Initial subarea data:
Equations shown use english units, converted if necessary to (SI)
Initial area flow distance = 634.000(Ft.)
Top (of initial area) elevation = 1012.000(Ft.)
Bottom (of initial area) elevation = 880.000(Ft.)
Difference in elevation = 132.000(Ft.)
Slope = 0.20820 s(%)= 20.82
Manual entry of initial area time of concentration, TC
Initial area time of concentration = 12.100 min.
Rainfall intensity = 2.169(In/Hr) for a 25.0 year storm
Effective runoff coefficient used for area (Q=KCIA) is C = 0.100
Subarea runoff = 0.241(CFS)
Total initial stream area = 1.110(Ac.)

+++++
Process from Point/Station 31.000 to Point/Station 32.000
**** IMPROVED CHANNEL TRAVEL TIME ****

Upstream point elevation = 880.000(Ft.)
Downstream point elevation = 821.900(Ft.)
Channel length thru subarea = 597.000(Ft.)
Channel base width = 20.000(Ft.)
Slope or 'Z' of left channel bank = 2.000
Slope or 'Z' of right channel bank = 2.000
Estimated mean flow rate at midpoint of channel = 0.460(CFS)
Manning's 'N' = 0.030
Maximum depth of channel = 0.500(Ft.)
Flow(q) thru subarea = 0.460(CFS)
Depth of flow = 0.020(Ft.), Average velocity = 1.141(Ft/s)
Channel flow top width = 20.080(Ft.)
Flow Velocity = 1.14(Ft/s)
Travel time = 8.72 min.
Time of concentration = 20.82 min.
Critical depth = 0.025(Ft.)
Adding area flow to channel
UNDEVELOPED (dense cover) subarea
Rainfall intensity = 1.646(In/Hr) for a 25.0 year storm
Subarea runoff = 0.333(CFS) for 2.020(Ac.)
Total runoff = 0.573(CFS) Total area = 3.130(Ac.)

+++++
Process from Point/Station 31.000 to Point/Station 32.000
**** CONFLUENCE OF MAIN STREAMS ****

The following data inside Main Stream is listed:
In Main Stream number: 3
Stream flow area = 3.130(Ac.)
Runoff from this stream = 0.573(CFS)

Time of concentration = 20.82 min.
Rainfall intensity = 1.646(In/Hr)
Program is now starting with Main Stream No. 4

++++
Process from Point/Station 40.000 to Point/Station 41.000
**** INITIAL AREA EVALUATION ****

UNDEVELOPED (dense cover) subarea
Initial subarea data:
Equations shown use english units, converted if necessary to (SI)
Initial area flow distance = 442.000(Ft.)
Top (of initial area) elevation = 754.000(Ft.)
Bottom (of initial area) elevation = 694.000(Ft.)
Difference in elevation = 60.000(Ft.)
Slope = 0.13575 s(%)= 13.57
Manual entry of initial area time of concentration, TC
Initial area time of concentration = 11.800 min.
Rainfall intensity = 2.199(In/Hr) for a 25.0 year storm
Effective runoff coefficient used for area (Q=KCIA) is C = 0.100
Subarea runoff = 0.477(CFS)
Total initial stream area = 2.170(Ac.)

++++
Process from Point/Station 40.000 to Point/Station 41.000
**** CONFLUENCE OF MAIN STREAMS ****

The following data inside Main Stream is listed:
In Main Stream number: 4
Stream flow area = 2.170(Ac.)
Runoff from this stream = 0.477(CFS)
Time of concentration = 11.80 min.
Rainfall intensity = 2.199(In/Hr)

Total of 4 main streams to confluence:
Flow rates before confluence point:
12.967 8.656 0.573 0.477
Area of streams before confluence:
63.140 54.360 3.130 2.170

Results of confluence:
Total flow rate = 22.673(CFS)
Time of concentration = 22.325 min.
Effective stream area after confluence = 122.800(Ac.)
End of computations, total study area = 122.800 (Ac.)

UNIVERSAL RATIONAL METHOD HYDROLOGY PROGRAM

CIVILCADD/CIVILDESIGN Engineering Software, (c) 1989- 2005 Version 7.1
Rational Hydrology Study Date: 03/21/09

EMSA

Existing Conditions

100-Year Flow Rate

County of Santa Clara Rational Method

***** Hydrology Study Control Information *****

Program License Serial Number 4028

Rational hydrology study storm event year is 100.0

Number of [time,intensity] data pairs = 8

No.	Time	-	Intensity
1	5.000		4.185(In.)
2	10.000		2.857(In.)
3	15.000		2.298(In.)
4	30.000		1.542(In.)
5	60.000		1.049(In.)
6	120.000		0.765(In.)
7	180.000		0.653(In.)
8	360.000		0.500(In.)

English Input Units Used

English Output Units Used:

Area = acres, Distance = feet, Flow q = ft³/s, Pipe diam. = inches

Runoff coefficient method used:

Runoff coefficient 'C' value calculated for the
equation $Q=KCIA$ [K=unit constant(1 if English Units, 1/360 if SI Units),
I=rainfall intensity, A=area];

by the following method:

Manual entry of 'C' values

Rational Hydrology Method used:

The rational hydrology method is used where the area
of each subarea in a stream, subarea 'C' value, and rain-
fall intensity for each subarea is used to determine the
subarea flow rate q, of which values are summed for total Q

Stream flow confluence option used:

Stream flow confluence method of 2 - 5 streams:

Note: in all cases, if the time of concentration

or TC of all streams are identical, then $q = \text{sum of stream flows}$

Variables p=peak; i=intensity; Fm=loss rate; a=area; 1...n flows

$q = \text{flow rate, } t = \text{time in minutes}$

Stream flows summed; $qp = q1 + q2 + \dots + qn$

TC = t of stream with largest q

+++++
Process from Point/Station 10.000 to Point/Station 11.000
**** INITIAL AREA EVALUATION ****

UNDEVELOPED (dense cover) subarea
Initial subarea data:
Equations shown use english units, converted if necessary to (SI)
Initial area flow distance = 919.000(Ft.)
Top (of initial area) elevation = 1355.000(Ft.)
Bottom (of initial area) elevation = 1050.000(Ft.)
Difference in elevation = 305.000(Ft.)
Slope = 0.33188 s(%)= 33.19
Manual entry of initial area time of concentration, TC
Initial area time of concentration = 12.300 min.
Rainfall intensity = 2.600(In/Hr) for a 100.0 year storm
Effective runoff coefficient used for area (Q=KCIA) is C = 0.100
Subarea runoff = 1.550(CFS)
Total initial stream area = 5.960(Ac.)

+++++
Process from Point/Station 11.000 to Point/Station 12.000
**** IMPROVED CHANNEL TRAVEL TIME ****

Upstream point elevation = 1050.000(Ft.)
Downstream point elevation = 920.000(Ft.)
Channel length thru subarea = 587.000(Ft.)
Channel base width = 10.000(Ft.)
Slope or 'Z' of left channel bank = 2.000
Slope or 'Z' of right channel bank = 2.000
Estimated mean flow rate at midpoint of channel = 3.199(CFS)
Manning's 'N' = 0.050
Maximum depth of channel = 5.000(Ft.)
Flow(q) thru subarea = 3.199(CFS)
Depth of flow = 0.103(Ft.), Average velocity = 3.031(Ft/s)
Channel flow top width = 10.414(Ft.)
Flow Velocity = 3.03(Ft/s)
Travel time = 3.23 min.
Time of concentration = 15.53 min.
Critical depth = 0.146(Ft.)
Adding area flow to channel
UNDEVELOPED (dense cover) subarea
Rainfall intensity = 2.271(In/Hr) for a 100.0 year storm
Subarea runoff = 2.882(CFS) for 12.690(Ac.)
Total runoff = 4.432(CFS) Total area = 18.650(Ac.)

+++++
Process from Point/Station 12.000 to Point/Station 13.000
**** IMPROVED CHANNEL TRAVEL TIME ****

Upstream point elevation = 920.000(Ft.)
Downstream point elevation = 850.000(Ft.)
Channel length thru subarea = 1040.000(Ft.)
Channel base width = 10.000(Ft.)

Slope or 'Z' of left channel bank = 10.000
 Slope or 'Z' of right channel bank = 10.000
 Estimated mean flow rate at midpoint of channel = 8.151(CFS)
 Manning's 'N' = 0.030
 Maximum depth of channel = 2.000(Ft.)
 Flow(q) thru subarea = 8.151(CFS)
 Depth of flow = 0.183(Ft.), Average velocity = 3.762(Ft/s)
 Channel flow top width = 13.663(Ft.)
 Flow Velocity = 3.76(Ft/s)
 Travel time = 4.61 min.
 Time of concentration = 20.14 min.
 Critical depth = 0.250(Ft.)
 Adding area flow to channel
 UNDEVELOPED (average cover) subarea
 Rainfall intensity = 2.039(In/Hr) for a 100.0 year storm
 Subarea runoff = 7.659(CFS) for 31.300(Ac.)
 Total runoff = 12.091(CFS) Total area = 49.950(Ac.)

++++++
 Process from Point/Station 13.000 to Point/Station 14.000
 **** IMPROVED CHANNEL TRAVEL TIME ****

Upstream point elevation = 850.000(Ft.)
 Downstream point elevation = 720.000(Ft.)
 Channel length thru subarea = 636.000(Ft.)
 Channel base width = 10.000(Ft.)
 Slope or 'Z' of left channel bank = 2.000
 Slope or 'Z' of right channel bank = 2.000
 Estimated mean flow rate at midpoint of channel = 13.687(CFS)
 Manning's 'N' = 0.030
 Maximum depth of channel = 2.000(Ft.)
 Flow(q) thru subarea = 13.687(CFS)
 Depth of flow = 0.186(Ft.), Average velocity = 7.091(Ft/s)
 Channel flow top width = 10.744(Ft.)
 Flow Velocity = 7.09(Ft/s)
 Travel time = 1.49 min.
 Time of concentration = 21.63 min.
 Critical depth = 0.379(Ft.)
 Adding area flow to channel
 UNDEVELOPED (poor cover) subarea
 Rainfall intensity = 1.964(In/Hr) for a 100.0 year storm
 Subarea runoff = 3.885(CFS) for 13.190(Ac.)
 Total runoff = 15.976(CFS) Total area = 63.140(Ac.)

++++++
 Process from Point/Station 13.000 to Point/Station 14.000
 **** CONFLUENCE OF MAIN STREAMS ****

The following data inside Main Stream is listed:
 In Main Stream number: 1
 Stream flow area = 63.140(Ac.)
 Runoff from this stream = 15.976(CFS)
 Time of concentration = 21.63 min.
 Rainfall intensity = 1.964(In/Hr)
 Program is now starting with Main Stream No. 2

+++++
Process from Point/Station 20.000 to Point/Station 21.000
**** INITIAL AREA EVALUATION ****

UNDEVELOPED (dense cover) subarea
Initial subarea data:
Equations shown use english units, converted if necessary to (SI)
Initial area flow distance = 581.000(Ft.)
Top (of initial area) elevation = 1074.000(Ft.)
Bottom (of initial area) elevation = 890.000(Ft.)
Difference in elevation = 184.000(Ft.)
Slope = 0.31670 s(%)= 31.67
Manual entry of initial area time of concentration, TC
Initial area time of concentration = 11.600 min.
Rainfall intensity = 2.678(In/Hr) for a 100.0 year storm
Effective runoff coefficient used for area (Q=KCIA) is C = 0.100
Subarea runoff = 0.699(CFS)
Total initial stream area = 2.610(Ac.)

+++++
Process from Point/Station 21.000 to Point/Station 22.000
**** IMPROVED CHANNEL TRAVEL TIME ****

Upstream point elevation = 890.000(Ft.)
Downstream point elevation = 830.000(Ft.)
Channel length thru subarea = 1040.000(Ft.)
Channel base width = 10.000(Ft.)
Slope or 'Z' of left channel bank = 3.000
Slope or 'Z' of right channel bank = 3.000
Estimated mean flow rate at midpoint of channel = 1.804(CFS)
Manning's 'N' = 0.030
Maximum depth of channel = 2.000(Ft.)
Flow(q) thru subarea = 1.804(CFS)
Depth of flow = 0.081(Ft.), Average velocity = 2.183(Ft/s)
Channel flow top width = 10.484(Ft.)
Flow Velocity = 2.18(Ft/s)
Travel time = 7.94 min.
Time of concentration = 19.54 min.
Critical depth = 0.100(Ft.)
Adding area flow to channel
UNDEVELOPED (average cover) subarea
Rainfall intensity = 2.069(In/Hr) for a 100.0 year storm
Subarea runoff = 2.049(CFS) for 8.250(Ac.)
Total runoff = 2.748(CFS) Total area = 10.860(Ac.)

+++++
Process from Point/Station 22.000 to Point/Station 23.000
**** IMPROVED CHANNEL TRAVEL TIME ****

Upstream point elevation = 830.000(Ft.)
Downstream point elevation = 700.000(Ft.)
Channel length thru subarea = 1602.000(Ft.)
Channel base width = 10.000(Ft.)

Slope or 'Z' of left channel bank = 2.000
 Slope or 'Z' of right channel bank = 2.000
 Estimated mean flow rate at midpoint of channel = 3.861(CFS)
 Manning's 'N' = 0.030
 Maximum depth of channel = 2.000(Ft.)
 Flow(q) thru subarea = 3.861(CFS)
 Depth of flow = 0.115(Ft.), Average velocity = 3.278(Ft/s)
 Channel flow top width = 10.460(Ft.)
 Flow Velocity = 3.28(Ft/s)
 Travel time = 8.14 min.
 Time of concentration = 27.68 min.
 Critical depth = 0.164(Ft.)
 Adding area flow to channel
 UNDEVELOPED (poor cover) subarea
 Rainfall intensity = 1.659(In/Hr) for a 100.0 year storm
 Subarea runoff = 1.898(CFS) for 8.800(Ac.)
 Total runoff = 4.645(CFS) Total area = 19.660(Ac.)

++++++
 Process from Point/Station 23.000 to Point/Station 24.000
 **** IMPROVED CHANNEL TRAVEL TIME ****

Upstream point elevation = 700.000(Ft.)
 Downstream point elevation = 556.000(Ft.)
 Channel length thru subarea = 1910.000(Ft.)
 Channel base width = 10.000(Ft.)
 Slope or 'Z' of left channel bank = 2.000
 Slope or 'Z' of right channel bank = 2.000
 Estimated mean flow rate at midpoint of channel = 8.744(CFS)
 Manning's 'N' = 0.030
 Maximum depth of channel = 2.000(Ft.)
 Flow(q) thru subarea = 8.744(CFS)
 Depth of flow = 0.192(Ft.), Average velocity = 4.391(Ft/s)
 Channel flow top width = 10.767(Ft.)
 Flow Velocity = 4.39(Ft/s)
 Travel time = 7.25 min.
 Time of concentration = 34.93 min.
 Critical depth = 0.281(Ft.)
 Adding area flow to channel
 UNDEVELOPED (average cover) subarea
 Rainfall intensity = 1.461(In/Hr) for a 100.0 year storm
 Subarea runoff = 6.083(CFS) for 34.700(Ac.)
 Total runoff = 10.728(CFS) Total area = 54.360(Ac.)

++++++
 Process from Point/Station 23.000 to Point/Station 24.000
 **** CONFLUENCE OF MAIN STREAMS ****

The following data inside Main Stream is listed:
 In Main Stream number: 2
 Stream flow area = 54.360(Ac.)
 Runoff from this stream = 10.728(CFS)
 Time of concentration = 34.93 min.
 Rainfall intensity = 1.461(In/Hr)
 Program is now starting with Main Stream No. 3

+++++
Process from Point/Station 30.000 to Point/Station 31.000
**** INITIAL AREA EVALUATION ****

UNDEVELOPED (dense cover) subarea
Initial subarea data:
Equations shown use english units, converted if necessary to (SI)
Initial area flow distance = 634.000(Ft.)
Top (of initial area) elevation = 1012.000(Ft.)
Bottom (of initial area) elevation = 880.000(Ft.)
Difference in elevation = 132.000(Ft.)
Slope = 0.20820 s(%)= 20.82
Manual entry of initial area time of concentration, TC
Initial area time of concentration = 12.100 min.
Rainfall intensity = 2.622(In/Hr) for a 100.0 year storm
Effective runoff coefficient used for area (Q=KCIA) is C = 0.100
Subarea runoff = 0.291(CFS)
Total initial stream area = 1.110(Ac.)

+++++
Process from Point/Station 31.000 to Point/Station 32.000
**** IMPROVED CHANNEL TRAVEL TIME ****

Upstream point elevation = 880.000(Ft.)
Downstream point elevation = 821.900(Ft.)
Channel length thru subarea = 597.000(Ft.)
Channel base width = 20.000(Ft.)
Slope or 'Z' of left channel bank = 2.000
Slope or 'Z' of right channel bank = 2.000
Estimated mean flow rate at midpoint of channel = 0.556(CFS)
Manning's 'N' = 0.030
Maximum depth of channel = 0.500(Ft.)
Flow(q) thru subarea = 0.556(CFS)
Depth of flow = 0.023(Ft.), Average velocity = 1.231(Ft/s)
Channel flow top width = 20.090(Ft.)
Flow Velocity = 1.23(Ft/s)
Travel time = 8.09 min.
Time of concentration = 20.19 min.
Critical depth = 0.029(Ft.)
Adding area flow to channel
UNDEVELOPED (dense cover) subarea
Rainfall intensity = 2.037(In/Hr) for a 100.0 year storm
Subarea runoff = 0.411(CFS) for 2.020(Ac.)
Total runoff = 0.702(CFS) Total area = 3.130(Ac.)

+++++
Process from Point/Station 31.000 to Point/Station 32.000
**** CONFLUENCE OF MAIN STREAMS ****

The following data inside Main Stream is listed:
In Main Stream number: 3
Stream flow area = 3.130(Ac.)
Runoff from this stream = 0.702(CFS)

Time of concentration = 20.19 min.
 Rainfall intensity = 2.037(In/Hr)
 Program is now starting with Main Stream No. 4

++++
 Process from Point/Station 40.000 to Point/Station 41.000
 **** INITIAL AREA EVALUATION ****

UNDEVELOPED (dense cover) subarea
 Initial subarea data:
 Equations shown use english units, converted if necessary to (SI)
 Initial area flow distance = 442.000(Ft.)
 Top (of initial area) elevation = 754.000(Ft.)
 Bottom (of initial area) elevation = 694.000(Ft.)
 Difference in elevation = 60.000(Ft.)
 Slope = 0.13575 s(%)= 13.57
 Manual entry of initial area time of concentration, TC
 Initial area time of concentration = 11.800 min.
 Rainfall intensity = 2.656(In/Hr) for a 100.0 year storm
 Effective runoff coefficient used for area (Q=KCIA) is C = 0.100
 Subarea runoff = 0.576(CFS)
 Total initial stream area = 2.170(Ac.)

++++
 Process from Point/Station 40.000 to Point/Station 41.000
 **** CONFLUENCE OF MAIN STREAMS ****

The following data inside Main Stream is listed:
 In Main Stream number: 4
 Stream flow area = 2.170(Ac.)
 Runoff from this stream = 0.576(CFS)
 Time of concentration = 11.80 min.
 Rainfall intensity = 2.656(In/Hr)

Total of 4 main streams to confluence:
 Flow rates before confluence point:
 15.976 10.728 0.702 0.576
 Area of streams before confluence:
 63.140 54.360 3.130 2.170

Results of confluence:
 Total flow rate = 27.984(CFS)
 Time of concentration = 21.630 min.
 Effective stream area after confluence = 122.800(Ac.)
 End of computations, total study area = 122.800 (Ac.)

UNIVERSAL RATIONAL METHOD HYDROLOGY PROGRAM

CIVILCADD/CIVILDESIGN Engineering Software, (c) 1989- 2005 Version 7.1
Rational Hydrology Study Date: 03/23/09

EMSA

Proposed Conditions

100-Year Flow Rate

County of Santa Clara Rational Method

***** Hydrology Study Control Information *****

Program License Serial Number 4028

Rational hydrology study storm event year is 25.0

Number of [time,intensity] data pairs = 8

No.	Time	-	Intensity
1	5.000		3.478(In.)
2	10.000		2.376(In.)
3	15.000		1.884(In.)
4	30.000		1.271(In.)
5	60.000		0.876(In.)
6	120.000		0.648(In.)
7	180.000		0.554(In.)
8	360.000		0.421(In.)

English Input Units Used

English Output Units Used:

Area = acres, Distance = feet, Flow q = ft³/s, Pipe diam. = inches

Runoff coefficient method used:

Runoff coefficient 'C' value calculated for the
equation $Q=KCIA$ [K=unit constant(1 if English Units, 1/360 if SI Units),
I=rainfall intensity, A=area];

by the following method:

Manual entry of 'C' values

Rational Hydrology Method used:

The rational hydrology method is used where the area
of each subarea in a stream, subarea 'C' value, and rain-
fall intensity for each subarea is used to determine the
subarea flow rate q, of which values are summed for total Q

Stream flow confluence option used:

Stream flow confluence method of 2 - 5 streams:

Note: in all cases, if the time of concentration

or TC of all streams are identical, then $q = \text{sum of stream flows}$

Variables p=peak; i=intensity; Fm=loss rate; a=area; 1...n flows

$q = \text{flow rate, } t = \text{time in minutes}$

Stream flows summed; $qp = q1 + q2 + \dots + qn$

TC = t of stream with largest q

+++++
Process from Point/Station 100.000 to Point/Station 101.000
**** INITIAL AREA EVALUATION ****

UNDEVELOPED (dense cover) subarea
Initial subarea data:
Equations shown use english units, converted if necessary to (SI)
Initial area flow distance = 919.000(Ft.)
Top (of initial area) elevation = 1355.000(Ft.)
Bottom (of initial area) elevation = 1050.000(Ft.)
Difference in elevation = 305.000(Ft.)
Slope = 0.33188 s(%)= 33.19
Manual entry of initial area time of concentration, TC
Initial area time of concentration = 12.300 min.
Rainfall intensity = 2.150(In/Hr) for a 25.0 year storm
Effective runoff coefficient used for area (Q=KCIA) is C = 0.100
Subarea runoff = 1.281(CFS)
Total initial stream area = 5.960(Ac.)

+++++
Process from Point/Station 101.000 to Point/Station 102.000
**** IMPROVED CHANNEL TRAVEL TIME ****

Upstream point elevation = 1050.000(Ft.)
Downstream point elevation = 920.000(Ft.)
Channel length thru subarea = 587.000(Ft.)
Channel base width = 10.000(Ft.)
Slope or 'Z' of left channel bank = 2.000
Slope or 'Z' of right channel bank = 2.000
Estimated mean flow rate at midpoint of channel = 2.645(CFS)
Manning's 'N' = 0.050
Maximum depth of channel = 5.000(Ft.)
Flow(q) thru subarea = 2.645(CFS)
Depth of flow = 0.092(Ft.), Average velocity = 2.814(Ft/s)
Channel flow top width = 10.369(Ft.)
Flow Velocity = 2.81(Ft/s)
Travel time = 3.48 min.
Time of concentration = 15.78 min.
Critical depth = 0.129(Ft.)
Adding area flow to channel
UNDEVELOPED (dense cover) subarea
Rainfall intensity = 1.852(In/Hr) for a 25.0 year storm
Subarea runoff = 2.351(CFS) for 12.690(Ac.)
Total runoff = 3.632(CFS) Total area = 18.650(Ac.)

+++++
Process from Point/Station 102.000 to Point/Station 103.000
**** IMPROVED CHANNEL TRAVEL TIME ****

Upstream point elevation = 920.000(Ft.)
Downstream point elevation = 860.000(Ft.)
Channel length thru subarea = 812.000(Ft.)
Channel base width = 10.000(Ft.)

Slope or 'Z' of left channel bank = 20.000
 Slope or 'Z' of right channel bank = 20.000
 Estimated mean flow rate at midpoint of channel = 6.334(CFS)
 Manning's 'N' = 0.030
 Maximum depth of channel = 2.000(Ft.)
 Flow(q) thru subarea = 6.334(CFS)
 Depth of flow = 0.148(Ft.), Average velocity = 3.289(Ft/s)
 Channel flow top width = 15.939(Ft.)
 Flow Velocity = 3.29(Ft/s)
 Travel time = 4.11 min.
 Time of concentration = 19.89 min.
 Critical depth = 0.201(Ft.)
 Adding area flow to channel
 UNDEVELOPED (average cover) subarea
 Rainfall intensity = 1.684(In/Hr) for a 25.0 year storm
 Subarea runoff = 5.608(CFS) for 27.750(Ac.)
 Total runoff = 9.240(CFS) Total area = 46.400(Ac.)

++++++
 Process from Point/Station 103.000 to Point/Station 104.000
 **** IMPROVED CHANNEL TRAVEL TIME ****

Upstream point elevation = 860.000(Ft.)
 Downstream point elevation = 694.000(Ft.)
 Channel length thru subarea = 1577.000(Ft.)
 Channel base width = 2.000(Ft.)
 Slope or 'Z' of left channel bank = 3.000
 Slope or 'Z' of right channel bank = 3.000
 Estimated mean flow rate at midpoint of channel = 10.419(CFS)
 Manning's 'N' = 0.040
 Maximum depth of channel = 2.000(Ft.)
 Flow(q) thru subarea = 10.419(CFS)
 Depth of flow = 0.504(Ft.), Average velocity = 5.886(Ft/s)
 Channel flow top width = 5.024(Ft.)
 Flow Velocity = 5.89(Ft/s)
 Travel time = 4.47 min.
 Time of concentration = 24.36 min.
 Critical depth = 0.680(Ft.)
 Adding area flow to channel
 UNDEVELOPED (dense cover) subarea
 Rainfall intensity = 1.502(In/Hr) for a 25.0 year storm
 Subarea runoff = 1.778(CFS) for 11.840(Ac.)
 Total runoff = 11.018(CFS) Total area = 58.240(Ac.)

++++++
 Process from Point/Station 103.000 to Point/Station 104.000
 **** CONFLUENCE OF MINOR STREAMS ****

Along Main Stream number: 1 in normal stream number 1
 Stream flow area = 58.240(Ac.)
 Runoff from this stream = 11.018(CFS)
 Time of concentration = 24.36 min.
 Rainfall intensity = 1.502(In/Hr)

Process from Point/Station 110.000 to Point/Station 111.000
***** INITIAL AREA EVALUATION *****

UNDEVELOPED (dense cover) subarea
Initial subarea data:
Equations shown use english units, converted if necessary to (SI)
Initial area flow distance = 140.000(Ft.)
Top (of initial area) elevation = 777.000(Ft.)
Bottom (of initial area) elevation = 725.000(Ft.)
Difference in elevation = 52.000(Ft.)
Slope = 0.37143 s(%)= 37.14
Manual entry of initial area time of concentration, TC
Initial area time of concentration = 10.500 min.
Rainfall intensity = 2.327(In/Hr) for a 25.0 year storm
Effective runoff coefficient used for area (Q=KCIA) is C = 0.100
Subarea runoff = 0.428(CFS)
Total initial stream area = 1.840(Ac.)

Process from Point/Station 110.000 to Point/Station 111.000
***** CONFLUENCE OF MINOR STREAMS *****

Along Main Stream number: 1 in normal stream number 2
Stream flow area = 1.840(Ac.)
Runoff from this stream = 0.428(CFS)
Time of concentration = 10.50 min.
Rainfall intensity = 2.327(In/Hr)

Total of 2 streams to confluence:
Flow rates before confluence point:
11.018 0.428
Area of streams before confluence:
58.240 1.840
Results of confluence:
Total flow rate = 11.446(CFS)
Time of concentration = 24.356 min.
Effective stream area after confluence = 60.080(Ac.)

Process from Point/Station 111.000 to Point/Station 111.000
***** CONFLUENCE OF MAIN STREAMS *****

The following data inside Main Stream is listed:
In Main Stream number: 1
Stream flow area = 60.080(Ac.)
Runoff from this stream = 11.446(CFS)
Time of concentration = 24.36 min.
Rainfall intensity = 1.502(In/Hr)
Program is now starting with Main Stream No. 2

Process from Point/Station 200.000 to Point/Station 201.000
***** INITIAL AREA EVALUATION *****

UNDEVELOPED (dense cover) subarea
Initial subarea data:
Equations shown use english units, converted if necessary to (SI)
Initial area flow distance = 581.000(Ft.)
Top (of initial area) elevation = 1074.000(Ft.)
Bottom (of initial area) elevation = 904.000(Ft.)
Difference in elevation = 170.000(Ft.)
Slope = 0.29260 s(%)= 29.26
Manual entry of initial area time of concentration, TC
Initial area time of concentration = 11.700 min.
Rainfall intensity = 2.209(In/Hr) for a 25.0 year storm
Effective runoff coefficient used for area (Q=KCIA) is C = 0.100
Subarea runoff = 0.576(CFS)
Total initial stream area = 2.610(Ac.)

+++++
Process from Point/Station 201.000 to Point/Station 202.000
**** IMPROVED CHANNEL TRAVEL TIME ****

Upstream point elevation = 904.000(Ft.)
Downstream point elevation = 895.000(Ft.)
Channel length thru subarea = 850.000(Ft.)
Channel base width = 10.000(Ft.)
Slope or 'Z' of left channel bank = 50.000
Slope or 'Z' of right channel bank = 50.000
Estimated mean flow rate at midpoint of channel = 1.777(CFS)
Manning's 'N' = 0.040
Maximum depth of channel = 1.000(Ft.)
Flow(q) thru subarea = 1.777(CFS)
Depth of flow = 0.134(Ft.), Average velocity = 0.798(Ft/s)
Channel flow top width = 23.354(Ft.)
Flow Velocity = 0.80(Ft/s)
Travel time = 17.76 min.
Time of concentration = 29.46 min.
Critical depth = 0.086(Ft.)
Adding area flow to channel
UNDEVELOPED (dense cover) subarea
Rainfall intensity = 1.293(In/Hr) for a 25.0 year storm
Subarea runoff = 1.406(CFS) for 10.870(Ac.)
Total runoff = 1.982(CFS) Total area = 13.480(Ac.)

+++++
Process from Point/Station 202.000 to Point/Station 203.000
**** IMPROVED CHANNEL TRAVEL TIME ****

Upstream point elevation = 895.000(Ft.)
Downstream point elevation = 820.000(Ft.)
Channel length thru subarea = 228.000(Ft.)
Channel base width = 2.000(Ft.)
Slope or 'Z' of left channel bank = 2.000
Slope or 'Z' of right channel bank = 2.000
Manning's 'N' = 0.040
Maximum depth of channel = 2.000(Ft.)
Flow(q) thru subarea = 1.982(CFS)

Depth of flow = 0.155(Ft.), Average velocity = 5.545(Ft/s)
Channel flow top width = 2.619(Ft.)
Flow Velocity = 5.55(Ft/s)
Travel time = 0.69 min.
Time of concentration = 30.14 min.
Critical depth = 0.281(Ft.)

++++
Process from Point/Station 203.000 to Point/Station 204.000
**** IMPROVED CHANNEL TRAVEL TIME ****

Upstream point elevation = 820.000(Ft.)
Downstream point elevation = 803.000(Ft.)
Channel length thru subarea = 1356.000(Ft.)
Channel base width = 2.000(Ft.)
Slope or 'Z' of left channel bank = 3.000
Slope or 'Z' of right channel bank = 3.000
Estimated mean flow rate at midpoint of channel = 2.581(CFS)
Manning's 'N' = 0.040
Maximum depth of channel = 2.000(Ft.)
Flow(q) thru subarea = 2.581(CFS)
Depth of flow = 0.425(Ft.), Average velocity = 1.852(Ft/s)
Channel flow top width = 4.552(Ft.)
Flow Velocity = 1.85(Ft/s)
Travel time = 12.20 min.
Time of concentration = 42.34 min.
Critical depth = 0.316(Ft.)
Adding area flow to channel
UNDEVELOPED (dense cover) subarea
Rainfall intensity = 1.108(In/Hr) for a 25.0 year storm
Subarea runoff = 0.903(CFS) for 8.150(Ac.)
Total runoff = 2.886(CFS) Total area = 21.630(Ac.)

++++
Process from Point/Station 204.000 to Point/Station 205.000
**** IMPROVED CHANNEL TRAVEL TIME ****

Upstream point elevation = 803.000(Ft.)
Downstream point elevation = 620.000(Ft.)
Channel length thru subarea = 1102.000(Ft.)
Channel base width = 2.000(Ft.)
Slope or 'Z' of left channel bank = 3.000
Slope or 'Z' of right channel bank = 3.000
Manning's 'N' = 0.040
Maximum depth of channel = 2.000(Ft.)
Flow(q) thru subarea = 2.886(CFS)
Depth of flow = 0.226(Ft.), Average velocity = 4.765(Ft/s)
Channel flow top width = 3.357(Ft.)
Flow Velocity = 4.76(Ft/s)
Travel time = 3.85 min.
Time of concentration = 46.20 min.
Critical depth = 0.336(Ft.)

++++

Process from Point/Station 205.000 to Point/Station 206.000
**** IMPROVED CHANNEL TRAVEL TIME ****

Upstream point elevation = 620.000(Ft.)
Downstream point elevation = 552.000(Ft.)
Channel length thru subarea = 356.000(Ft.)
Channel base width = 2.000(Ft.)
Slope or 'Z' of left channel bank = 3.000
Slope or 'Z' of right channel bank = 3.000
Estimated mean flow rate at midpoint of channel = 3.908(CFS)
Manning's 'N' = 0.040
Maximum depth of channel = 2.000(Ft.)
Flow(q) thru subarea = 3.908(CFS)
Depth of flow = 0.257(Ft.), Average velocity = 5.487(Ft/s)
Channel flow top width = 3.542(Ft.)
Flow Velocity = 5.49(Ft/s)
Travel time = 1.08 min.
Time of concentration = 47.28 min.
Critical depth = 0.398(Ft.)
Adding area flow to channel
UNDEVELOPED (dense cover) subarea
Rainfall intensity = 1.043(In/Hr) for a 25.0 year storm
Subarea runoff = 1.599(CFS) for 15.320(Ac.)
Total runoff = 4.484(CFS) Total area = 36.950(Ac.)

Process from Point/Station 205.000 to Point/Station 206.000
**** CONFLUENCE OF MINOR STREAMS ****

Along Main Stream number: 2 in normal stream number 1
Stream flow area = 36.950(Ac.)
Runoff from this stream = 4.484(CFS)
Time of concentration = 47.28 min.
Rainfall intensity = 1.043(In/Hr)

Process from Point/Station 210.000 to Point/Station 211.000
**** INITIAL AREA EVALUATION ****

UNDEVELOPED (dense cover) subarea
Initial subarea data:
Equations shown use english units, converted if necessary to (SI)
Initial area flow distance = 443.000(Ft.)
Top (of initial area) elevation = 860.000(Ft.)
Bottom (of initial area) elevation = 855.500(Ft.)
Difference in elevation = 4.500(Ft.)
Slope = 0.01016 s(%)= 1.02
Manual entry of initial area time of concentration, TC
Initial area time of concentration = 15.000 min.
Rainfall intensity = 1.884(In/Hr) for a 25.0 year storm
Effective runoff coefficient used for area (Q=KCIA) is C = 0.100
Subarea runoff = 0.090(CFS)
Total initial stream area = 0.480(Ac.)

+++++
Process from Point/Station 211.000 to Point/Station 212.000
**** IMPROVED CHANNEL TRAVEL TIME ****

Upstream point elevation = 855.500(Ft.)
Downstream point elevation = 726.000(Ft.)
Channel length thru subarea = 311.000(Ft.)
Channel base width = 2.000(Ft.)
Slope or 'Z' of left channel bank = 2.000
Slope or 'Z' of right channel bank = 2.000
Estimated mean flow rate at midpoint of channel = 0.434(CFS)
Manning's 'N' = 0.040
Maximum depth of channel = 2.000(Ft.)
Flow(q) thru subarea = 0.434(CFS)
Depth of flow = 0.059(Ft.), Average velocity = 3.475(Ft/s)
Channel flow top width = 2.236(Ft.)
Flow Velocity = 3.48(Ft/s)
Travel time = 1.49 min.
Time of concentration = 16.49 min.
Critical depth = 0.109(Ft.)
Adding area flow to channel
UNDEVELOPED (dense cover) subarea
Rainfall intensity = 1.823(In/Hr) for a 25.0 year storm
Subarea runoff = 0.665(CFS) for 3.650(Ac.)
Total runoff = 0.756(CFS) Total area = 4.130(Ac.)

+++++
Process from Point/Station 212.000 to Point/Station 213.000
**** IMPROVED CHANNEL TRAVEL TIME ****

Upstream point elevation = 726.000(Ft.)
Downstream point elevation = 570.000(Ft.)
Channel length thru subarea = 700.000(Ft.)
Channel base width = 2.000(Ft.)
Slope or 'Z' of left channel bank = 2.000
Slope or 'Z' of right channel bank = 2.000
Estimated mean flow rate at midpoint of channel = 1.262(CFS)
Manning's 'N' = 0.040
Maximum depth of channel = 2.000(Ft.)
Flow(q) thru subarea = 1.262(CFS)
Depth of flow = 0.133(Ft.), Average velocity = 4.179(Ft/s)
Channel flow top width = 2.533(Ft.)
Flow Velocity = 4.18(Ft/s)
Travel time = 2.79 min.
Time of concentration = 19.28 min.
Critical depth = 0.215(Ft.)
Adding area flow to channel
UNDEVELOPED (dense cover) subarea
Rainfall intensity = 1.709(In/Hr) for a 25.0 year storm
Subarea runoff = 0.945(CFS) for 5.530(Ac.)
Total runoff = 1.701(CFS) Total area = 9.660(Ac.)

+++++
Process from Point/Station 212.000 to Point/Station 213.000
**** CONFLUENCE OF MINOR STREAMS ****

Along Main Stream number: 2 in normal stream number 2
Stream flow area = 9.660(Ac.)
Runoff from this stream = 1.701(CFS)
Time of concentration = 19.28 min.
Rainfall intensity = 1.709(In/Hr)

Process from Point/Station 220.000 to Point/Station 221.000
**** INITIAL AREA EVALUATION ****

UNDEVELOPED (dense cover) subarea
Initial subarea data:
Equations shown use english units, converted if necessary to (SI)
Initial area flow distance = 919.000(Ft.)
Top (of initial area) elevation = 645.000(Ft.)
Bottom (of initial area) elevation = 636.000(Ft.)
Difference in elevation = 9.000(Ft.)
Slope = 0.00979 s(%)= 0.98
Manual entry of initial area time of concentration, TC
Initial area time of concentration = 18.900 min.
Rainfall intensity = 1.725(In/Hr) for a 25.0 year storm
Effective runoff coefficient used for area (Q=KCIA) is C = 0.100
Subarea runoff = 0.510(CFS)
Total initial stream area = 2.960(Ac.)

Process from Point/Station 221.000 to Point/Station 222.000
**** IMPROVED CHANNEL TRAVEL TIME ****

Upstream point elevation = 636.000(Ft.)
Downstream point elevation = 561.000(Ft.)
Channel length thru subarea = 178.000(Ft.)
Channel base width = 2.000(Ft.)
Slope or 'Z' of left channel bank = 2.000
Slope or 'Z' of right channel bank = 2.000
Manning's 'N' = 0.040
Maximum depth of channel = 2.000(Ft.)
Flow(q) thru subarea = 0.510(CFS)
Depth of flow = 0.065(Ft.), Average velocity = 3.704(Ft/s)
Channel flow top width = 2.259(Ft.)
Flow Velocity = 3.70(Ft/s)
Travel time = 0.80 min.
Time of concentration = 19.70 min.
Critical depth = 0.121(Ft.)

Process from Point/Station 222.000 to Point/Station 223.000
**** IMPROVED CHANNEL TRAVEL TIME ****

Upstream point elevation = 561.000(Ft.)
Downstream point elevation = 558.000(Ft.)
Channel length thru subarea = 370.000(Ft.)
Channel base width = 2.000(Ft.)

Slope or 'Z' of left channel bank = 3.000
 Slope or 'Z' of right channel bank = 3.000
 Estimated mean flow rate at midpoint of channel = 1.110(CFS)
 Manning's 'N' = 0.040
 Maximum depth of channel = 2.000(Ft.)
 Flow(q) thru subarea = 1.110(CFS)
 Depth of flow = 0.306(Ft.), Average velocity = 1.244(Ft/s)
 Channel flow top width = 3.835(Ft.)
 Flow Velocity = 1.24(Ft/s)
 Travel time = 4.96 min.
 Time of concentration = 24.66 min.
 Critical depth = 0.191(Ft.)
 Adding area flow to channel
 UNDEVELOPED (dense cover) subarea
 Rainfall intensity = 1.489(In/Hr) for a 25.0 year storm
 Subarea runoff = 1.035(CFS) for 6.950(Ac.)
 Total runoff = 1.546(CFS) Total area = 9.910(Ac.)

++++++
 Process from Point/Station 222.000 to Point/Station 223.000
 **** CONFLUENCE OF MINOR STREAMS ****

Along Main Stream number: 2 in normal stream number 3
 Stream flow area = 9.910(Ac.)
 Runoff from this stream = 1.546(CFS)
 Time of concentration = 24.66 min.
 Rainfall intensity = 1.489(In/Hr)

Total of 3 streams to confluence:
 Flow rates before confluence point:
 4.484 1.701 1.546
 Area of streams before confluence:
 36.950 9.660 9.910
 Results of confluence:
 Total flow rate = 7.731(CFS)
 Time of concentration = 47.279 min.
 Effective stream area after confluence = 56.520(Ac.)

++++++
 Process from Point/Station 223.000 to Point/Station 223.000
 **** CONFLUENCE OF MAIN STREAMS ****

The following data inside Main Stream is listed:
 In Main Stream number: 2
 Stream flow area = 56.520(Ac.)
 Runoff from this stream = 7.731(CFS)
 Time of concentration = 47.28 min.
 Rainfall intensity = 1.043(In/Hr)
 Program is now starting with Main Stream No. 3

++++++
 Process from Point/Station 300.000 to Point/Station 301.000
 **** INITIAL AREA EVALUATION ****

UNDEVELOPED (dense cover) subarea
 Initial subarea data:
 Equations shown use english units, converted if necessary to (SI)
 Initial area flow distance = 758.000(Ft.)
 Top (of initial area) elevation = 1015.000(Ft.)
 Bottom (of initial area) elevation = 900.000(Ft.)
 Difference in elevation = 115.000(Ft.)
 Slope = 0.15172 s(%)= 15.17
 Manual entry of initial area time of concentration, TC
 Initial area time of concentration = 12.700 min.
 Rainfall intensity = 2.110(In/Hr) for a 25.0 year storm
 Effective runoff coefficient used for area (Q=KCIA) is C = 0.100
 Subarea runoff = 0.196(CFS)
 Total initial stream area = 0.930(Ac.)

++++
 Process from Point/Station 301.000 to Point/Station 302.000
 **** IMPROVED CHANNEL TRAVEL TIME ****

Upstream point elevation = 900.000(Ft.)
 Downstream point elevation = 815.000(Ft.)
 Channel length thru subarea = 578.000(Ft.)
 Channel base width = 2.000(Ft.)
 Slope or 'Z' of left channel bank = 3.000
 Slope or 'Z' of right channel bank = 3.000
 Estimated mean flow rate at midpoint of channel = 0.413(CFS)
 Manning's 'N' = 0.040
 Maximum depth of channel = 2.000(Ft.)
 Flow(q) thru subarea = 0.413(CFS)
 Depth of flow = 0.077(Ft.), Average velocity = 2.399(Ft/s)
 Channel flow top width = 2.462(Ft.)
 Flow Velocity = 2.40(Ft/s)
 Travel time = 4.01 min.
 Time of concentration = 16.71 min.
 Critical depth = 0.104(Ft.)
 Adding area flow to channel
 UNDEVELOPED (dense cover) subarea
 Rainfall intensity = 1.814(In/Hr) for a 25.0 year storm
 Subarea runoff = 0.372(CFS) for 2.050(Ac.)
 Total runoff = 0.568(CFS) Total area = 2.980(Ac.)

++++
 Process from Point/Station 301.000 to Point/Station 302.000
 **** CONFLUENCE OF MAIN STREAMS ****

The following data inside Main Stream is listed:
 In Main Stream number: 3
 Stream flow area = 2.980(Ac.)
 Runoff from this stream = 0.568(CFS)
 Time of concentration = 16.71 min.
 Rainfall intensity = 1.814(In/Hr)
 Program is now starting with Main Stream No. 4

++++

Process from Point/Station 400.000 to Point/Station 401.000
**** INITIAL AREA EVALUATION ****

UNDEVELOPED (dense cover) subarea
Initial subarea data:
Equations shown use english units, converted if necessary to (SI)
Initial area flow distance = 938.000(Ft.)
Top (of initial area) elevation = 815.000(Ft.)
Bottom (of initial area) elevation = 700.000(Ft.)
Difference in elevation = 115.000(Ft.)
Slope = 0.12260 s(%)= 12.26
Manual entry of initial area time of concentration, TC
Initial area time of concentration = 13.400 min.
Rainfall intensity = 2.041(In/Hr) for a 25.0 year storm
Effective runoff coefficient used for area (Q=KCIA) is C = 0.100
Subarea runoff = 0.398(CFS)
Total initial stream area = 1.950(Ac.)

+++++
Process from Point/Station 400.000 to Point/Station 401.000
**** CONFLUENCE OF MINOR STREAMS ****

Along Main Stream number: 4 in normal stream number 1
Stream flow area = 1.950(Ac.)
Runoff from this stream = 0.398(CFS)
Time of concentration = 13.40 min.
Rainfall intensity = 2.041(In/Hr)

+++++
Process from Point/Station 402.000 to Point/Station 403.000
**** INITIAL AREA EVALUATION ****

UNDEVELOPED (dense cover) subarea
Initial subarea data:
Equations shown use english units, converted if necessary to (SI)
Initial area flow distance = 631.000(Ft.)
Top (of initial area) elevation = 705.000(Ft.)
Bottom (of initial area) elevation = 686.000(Ft.)
Difference in elevation = 19.000(Ft.)
Slope = 0.03011 s(%)= 3.01
Manual entry of initial area time of concentration, TC
Initial area time of concentration = 14.300 min.
Rainfall intensity = 1.953(In/Hr) for a 25.0 year storm
Effective runoff coefficient used for area (Q=KCIA) is C = 0.100
Subarea runoff = 0.248(CFS)
Total initial stream area = 1.270(Ac.)

+++++
Process from Point/Station 402.000 to Point/Station 403.000
**** CONFLUENCE OF MINOR STREAMS ****

Along Main Stream number: 4 in normal stream number 2
Stream flow area = 1.270(Ac.)
Runoff from this stream = 0.248(CFS)

Time of concentration = 14.30 min.
Rainfall intensity = 1.953(In/Hr)

Total of 2 streams to confluence:
Flow rates before confluence point:

0.398 0.248

Area of streams before confluence:

1.950 1.270

Results of confluence:

Total flow rate = 0.646(CFS)

Time of concentration = 13.400 min.

Effective stream area after confluence = 3.220(Ac.)

+++++
Process from Point/Station 403.000 to Point/Station 403.000
**** CONFLUENCE OF MAIN STREAMS ****

The following data inside Main Stream is listed:

In Main Stream number: 4

Stream flow area = 3.220(Ac.)

Runoff from this stream = 0.646(CFS)

Time of concentration = 13.40 min.

Rainfall intensity = 2.041(In/Hr)

Total of 4 main streams to confluence:

Flow rates before confluence point:

11.446 7.731 0.568 0.646

Area of streams before confluence:

60.080 56.520 2.980 3.220

Results of confluence:

Total flow rate = 20.391(CFS)

Time of concentration = 24.356 min.

Effective stream area after confluence = 122.800(Ac.)

End of computations, total study area = 122.800 (Ac.)

UNIVERSAL RATIONAL METHOD HYDROLOGY PROGRAM

CIVILCADD/CIVILDESIGN Engineering Software, (c) 1989- 2005 Version 7.1
Rational Hydrology Study Date: 03/23/09

EMSA

Proposed Conditions

100-Year Flow Rate

County of Santa Clara Rational Method

***** Hydrology Study Control Information *****

Program License Serial Number 4028

Rational hydrology study storm event year is 100.0

Number of [time,intensity] data pairs = 8

No.	Time	-	Intensity
1	5.000		4.185(In.)
2	10.000		2.857(In.)
3	15.000		2.298(In.)
4	30.000		1.542(In.)
5	60.000		1.049(In.)
6	120.000		0.765(In.)
7	180.000		0.653(In.)
8	360.000		0.500(In.)

English Input Units Used

English Output Units Used:

Area = acres, Distance = feet, Flow q = ft³/s, Pipe diam. = inches

Runoff coefficient method used:

Runoff coefficient 'C' value calculated for the
equation $Q=KCIA$ [K=unit constant(1 if English Units, 1/360 if SI Units),
I=rainfall intensity, A=area];

by the following method:

Manual entry of 'C' values

Rational Hydrology Method used:

The rational hydrology method is used where the area
of each subarea in a stream, subarea 'C' value, and rain-
fall intensity for each subarea is used to determine the
subarea flow rate q, of which values are summed for total Q

Stream flow confluence option used:

Stream flow confluence method of 2 - 5 streams:

Note: in all cases, if the time of concentration

or TC of all streams are identical, then $q = \text{sum of stream flows}$

Variables p=peak; i=intensity; Fm=loss rate; a=area; 1...n flows

$q = \text{flow rate, } t = \text{time in minutes}$

Stream flows summed; $qp = q1 + q2 + \dots + qn$

TC = t of stream with largest q

+++++
Process from Point/Station 100.000 to Point/Station 101.000
**** INITIAL AREA EVALUATION ****

UNDEVELOPED (dense cover) subarea
Initial subarea data:
Equations shown use english units, converted if necessary to (SI)
Initial area flow distance = 919.000(Ft.)
Top (of initial area) elevation = 1355.000(Ft.)
Bottom (of initial area) elevation = 1050.000(Ft.)
Difference in elevation = 305.000(Ft.)
Slope = 0.33188 s(%)= 33.19
Manual entry of initial area time of concentration, TC
Initial area time of concentration = 12.300 min.
Rainfall intensity = 2.600(In/Hr) for a 100.0 year storm
Effective runoff coefficient used for area (Q=KCIA) is C = 0.100
Subarea runoff = 1.550(CFS)
Total initial stream area = 5.960(Ac.)

+++++
Process from Point/Station 101.000 to Point/Station 102.000
**** IMPROVED CHANNEL TRAVEL TIME ****

Upstream point elevation = 1050.000(Ft.)
Downstream point elevation = 920.000(Ft.)
Channel length thru subarea = 587.000(Ft.)
Channel base width = 10.000(Ft.)
Slope or 'Z' of left channel bank = 2.000
Slope or 'Z' of right channel bank = 2.000
Estimated mean flow rate at midpoint of channel = 3.199(CFS)
Manning's 'N' = 0.050
Maximum depth of channel = 5.000(Ft.)
Flow(q) thru subarea = 3.199(CFS)
Depth of flow = 0.103(Ft.), Average velocity = 3.031(Ft/s)
Channel flow top width = 10.414(Ft.)
Flow Velocity = 3.03(Ft/s)
Travel time = 3.23 min.
Time of concentration = 15.53 min.
Critical depth = 0.146(Ft.)
Adding area flow to channel
UNDEVELOPED (dense cover) subarea
Rainfall intensity = 2.271(In/Hr) for a 100.0 year storm
Subarea runoff = 2.882(CFS) for 12.690(Ac.)
Total runoff = 4.432(CFS) Total area = 18.650(Ac.)

+++++
Process from Point/Station 102.000 to Point/Station 103.000
**** IMPROVED CHANNEL TRAVEL TIME ****

Upstream point elevation = 920.000(Ft.)
Downstream point elevation = 860.000(Ft.)
Channel length thru subarea = 812.000(Ft.)
Channel base width = 10.000(Ft.)

Slope or 'Z' of left channel bank = 20.000
 Slope or 'Z' of right channel bank = 20.000
 Estimated mean flow rate at midpoint of channel = 7.729(CFS)
 Manning's 'N' = 0.030
 Maximum depth of channel = 2.000(Ft.)
 Flow(q) thru subarea = 7.729(CFS)
 Depth of flow = 0.166(Ft.), Average velocity = 3.502(Ft/s)
 Channel flow top width = 16.630(Ft.)
 Flow Velocity = 3.50(Ft/s)
 Travel time = 3.86 min.
 Time of concentration = 19.39 min.
 Critical depth = 0.227(Ft.)
 Adding area flow to channel
 UNDEVELOPED (average cover) subarea
 Rainfall intensity = 2.077(In/Hr) for a 100.0 year storm
 Subarea runoff = 6.915(CFS) for 27.750(Ac.)
 Total runoff = 11.347(CFS) Total area = 46.400(Ac.)

++++++
 Process from Point/Station 103.000 to Point/Station 104.000
 **** IMPROVED CHANNEL TRAVEL TIME ****

Upstream point elevation = 860.000(Ft.)
 Downstream point elevation = 694.000(Ft.)
 Channel length thru subarea = 1577.000(Ft.)
 Channel base width = 2.000(Ft.)
 Slope or 'Z' of left channel bank = 3.000
 Slope or 'Z' of right channel bank = 3.000
 Estimated mean flow rate at midpoint of channel = 12.795(CFS)
 Manning's 'N' = 0.040
 Maximum depth of channel = 2.000(Ft.)
 Flow(q) thru subarea = 12.795(CFS)
 Depth of flow = 0.559(Ft.), Average velocity = 6.226(Ft/s)
 Channel flow top width = 5.353(Ft.)
 Flow Velocity = 6.23(Ft/s)
 Travel time = 4.22 min.
 Time of concentration = 23.61 min.
 Critical depth = 0.754(Ft.)
 Adding area flow to channel
 UNDEVELOPED (dense cover) subarea
 Rainfall intensity = 1.864(In/Hr) for a 100.0 year storm
 Subarea runoff = 2.207(CFS) for 11.840(Ac.)
 Total runoff = 13.554(CFS) Total area = 58.240(Ac.)

++++++
 Process from Point/Station 103.000 to Point/Station 104.000
 **** CONFLUENCE OF MINOR STREAMS ****

Along Main Stream number: 1 in normal stream number 1
 Stream flow area = 58.240(Ac.)
 Runoff from this stream = 13.554(CFS)
 Time of concentration = 23.61 min.
 Rainfall intensity = 1.864(In/Hr)

+++++
Process from Point/Station 110.000 to Point/Station 111.000
**** INITIAL AREA EVALUATION ****

UNDEVELOPED (dense cover) subarea
Initial subarea data:
Equations shown use english units, converted if necessary to (SI)
Initial area flow distance = 140.000(Ft.)
Top (of initial area) elevation = 777.000(Ft.)
Bottom (of initial area) elevation = 725.000(Ft.)
Difference in elevation = 52.000(Ft.)
Slope = 0.37143 s(%)= 37.14
Manual entry of initial area time of concentration, TC
Initial area time of concentration = 10.500 min.
Rainfall intensity = 2.801(In/Hr) for a 100.0 year storm
Effective runoff coefficient used for area (Q=KCIA) is C = 0.100
Subarea runoff = 0.515(CFS)
Total initial stream area = 1.840(Ac.)

+++++
Process from Point/Station 110.000 to Point/Station 111.000
**** CONFLUENCE OF MINOR STREAMS ****

Along Main Stream number: 1 in normal stream number 2
Stream flow area = 1.840(Ac.)
Runoff from this stream = 0.515(CFS)
Time of concentration = 10.50 min.
Rainfall intensity = 2.801(In/Hr)

Total of 2 streams to confluence:
Flow rates before confluence point:
13.554 0.515
Area of streams before confluence:
58.240 1.840
Results of confluence:
Total flow rate = 14.069(CFS)
Time of concentration = 23.614 min.
Effective stream area after confluence = 60.080(Ac.)

+++++
Process from Point/Station 111.000 to Point/Station 111.000
**** CONFLUENCE OF MAIN STREAMS ****

The following data inside Main Stream is listed:
In Main Stream number: 1
Stream flow area = 60.080(Ac.)
Runoff from this stream = 14.069(CFS)
Time of concentration = 23.61 min.
Rainfall intensity = 1.864(In/Hr)
Program is now starting with Main Stream No. 2

+++++
Process from Point/Station 200.000 to Point/Station 201.000
**** INITIAL AREA EVALUATION ****

UNDEVELOPED (dense cover) subarea

Initial subarea data:

Equations shown use english units, converted if necessary to (SI)

Initial area flow distance = 581.000(Ft.)

Top (of initial area) elevation = 1074.000(Ft.)

Bottom (of initial area) elevation = 904.000(Ft.)

Difference in elevation = 170.000(Ft.)

Slope = 0.29260 s(%)= 29.26

Manual entry of initial area time of concentration, TC

Initial area time of concentration = 11.700 min.

Rainfall intensity = 2.667(In/Hr) for a 100.0 year storm

Effective runoff coefficient used for area (Q=KCIA) is C = 0.100

Subarea runoff = 0.696(CFS)

Total initial stream area = 2.610(Ac.)

Process from Point/Station 201.000 to Point/Station 202.000
**** IMPROVED CHANNEL TRAVEL TIME ****

Upstream point elevation = 904.000(Ft.)

Downstream point elevation = 895.000(Ft.)

Channel length thru subarea = 850.000(Ft.)

Channel base width = 10.000(Ft.)

Slope or 'Z' of left channel bank = 50.000

Slope or 'Z' of right channel bank = 50.000

Estimated mean flow rate at midpoint of channel = 2.146(CFS)

Manning's 'N' = 0.040

Maximum depth of channel = 1.000(Ft.)

Flow(q) thru subarea = 2.146(CFS)

Depth of flow = 0.147(Ft.), Average velocity = 0.841(Ft/s)

Channel flow top width = 24.700(Ft.)

Flow Velocity = 0.84(Ft/s)

Travel time = 16.84 min.

Time of concentration = 28.54 min.

Critical depth = 0.096(Ft.)

Adding area flow to channel

UNDEVELOPED (dense cover) subarea

Rainfall intensity = 1.616(In/Hr) for a 100.0 year storm

Subarea runoff = 1.756(CFS) for 10.870(Ac.)

Total runoff = 2.452(CFS) Total area = 13.480(Ac.)

Process from Point/Station 202.000 to Point/Station 203.000
**** IMPROVED CHANNEL TRAVEL TIME ****

Upstream point elevation = 895.000(Ft.)

Downstream point elevation = 820.000(Ft.)

Channel length thru subarea = 228.000(Ft.)

Channel base width = 2.000(Ft.)

Slope or 'Z' of left channel bank = 2.000

Slope or 'Z' of right channel bank = 2.000

Manning's 'N' = 0.040

Maximum depth of channel = 2.000(Ft.)

Flow(q) thru subarea = 2.452(CFS)

Depth of flow = 0.175(Ft.), Average velocity = 5.958(Ft/s)
Channel flow top width = 2.700(Ft.)
Flow Velocity = 5.96(Ft/s)
Travel time = 0.64 min.
Time of concentration = 29.18 min.
Critical depth = 0.320(Ft.)

++++
Process from Point/Station 203.000 to Point/Station 204.000
**** IMPROVED CHANNEL TRAVEL TIME ****

Upstream point elevation = 820.000(Ft.)
Downstream point elevation = 803.000(Ft.)
Channel length thru subarea = 1356.000(Ft.)
Channel base width = 2.000(Ft.)
Slope or 'Z' of left channel bank = 3.000
Slope or 'Z' of right channel bank = 3.000
Estimated mean flow rate at midpoint of channel = 3.194(CFS)
Manning's 'N' = 0.040
Maximum depth of channel = 2.000(Ft.)
Flow(q) thru subarea = 3.194(CFS)
Depth of flow = 0.475(Ft.), Average velocity = 1.966(Ft/s)
Channel flow top width = 4.847(Ft.)
Flow Velocity = 1.97(Ft/s)
Travel time = 11.50 min.
Time of concentration = 40.67 min.
Critical depth = 0.355(Ft.)
Adding area flow to channel
UNDEVELOPED (dense cover) subarea
Rainfall intensity = 1.367(In/Hr) for a 100.0 year storm
Subarea runoff = 1.114(CFS) for 8.150(Ac.)
Total runoff = 3.566(CFS) Total area = 21.630(Ac.)

++++
Process from Point/Station 204.000 to Point/Station 205.000
**** IMPROVED CHANNEL TRAVEL TIME ****

Upstream point elevation = 803.000(Ft.)
Downstream point elevation = 620.000(Ft.)
Channel length thru subarea = 1102.000(Ft.)
Channel base width = 2.000(Ft.)
Slope or 'Z' of left channel bank = 3.000
Slope or 'Z' of right channel bank = 3.000
Manning's 'N' = 0.040
Maximum depth of channel = 2.000(Ft.)
Flow(q) thru subarea = 3.566(CFS)
Depth of flow = 0.254(Ft.), Average velocity = 5.083(Ft/s)
Channel flow top width = 3.524(Ft.)
Flow Velocity = 5.08(Ft/s)
Travel time = 3.61 min.
Time of concentration = 44.29 min.
Critical depth = 0.379(Ft.)

++++

Process from Point/Station 205.000 to Point/Station 206.000
**** IMPROVED CHANNEL TRAVEL TIME ****

Upstream point elevation = 620.000(Ft.)
Downstream point elevation = 552.000(Ft.)
Channel length thru subarea = 356.000(Ft.)
Channel base width = 2.000(Ft.)
Slope or 'Z' of left channel bank = 3.000
Slope or 'Z' of right channel bank = 3.000
Estimated mean flow rate at midpoint of channel = 4.829(CFS)
Manning's 'N' = 0.040
Maximum depth of channel = 2.000(Ft.)
Flow(q) thru subarea = 4.829(CFS)
Depth of flow = 0.288(Ft.), Average velocity = 5.846(Ft/s)
Channel flow top width = 3.730(Ft.)
Flow Velocity = 5.85(Ft/s)
Travel time = 1.01 min.
Time of concentration = 45.30 min.
Critical depth = 0.449(Ft.)
Adding area flow to channel
UNDEVELOPED (dense cover) subarea
Rainfall intensity = 1.291(In/Hr) for a 100.0 year storm
Subarea runoff = 1.977(CFS) for 15.320(Ac.)
Total runoff = 5.543(CFS) Total area = 36.950(Ac.)

Process from Point/Station 205.000 to Point/Station 206.000
**** CONFLUENCE OF MINOR STREAMS ****

Along Main Stream number: 2 in normal stream number 1
Stream flow area = 36.950(Ac.)
Runoff from this stream = 5.543(CFS)
Time of concentration = 45.30 min.
Rainfall intensity = 1.291(In/Hr)

Process from Point/Station 210.000 to Point/Station 211.000
**** INITIAL AREA EVALUATION ****

UNDEVELOPED (dense cover) subarea
Initial subarea data:
Equations shown use english units, converted if necessary to (SI)
Initial area flow distance = 443.000(Ft.)
Top (of initial area) elevation = 860.000(Ft.)
Bottom (of initial area) elevation = 855.500(Ft.)
Difference in elevation = 4.500(Ft.)
Slope = 0.01016 s(%)= 1.02
Manual entry of initial area time of concentration, TC
Initial area time of concentration = 15.000 min.
Rainfall intensity = 2.298(In/Hr) for a 100.0 year storm
Effective runoff coefficient used for area (Q=KCIA) is C = 0.100
Subarea runoff = 0.110(CFS)
Total initial stream area = 0.480(Ac.)

+++++
Process from Point/Station 211.000 to Point/Station 212.000
**** IMPROVED CHANNEL TRAVEL TIME ****

Upstream point elevation = 855.500(Ft.)
Downstream point elevation = 726.000(Ft.)
Channel length thru subarea = 311.000(Ft.)
Channel base width = 2.000(Ft.)
Slope or 'Z' of left channel bank = 2.000
Slope or 'Z' of right channel bank = 2.000
Estimated mean flow rate at midpoint of channel = 0.530(CFS)
Manning's 'N' = 0.040
Maximum depth of channel = 2.000(Ft.)
Flow(q) thru subarea = 0.530(CFS)
Depth of flow = 0.066(Ft.), Average velocity = 3.741(Ft/s)
Channel flow top width = 2.266(Ft.)
Flow Velocity = 3.74(Ft/s)
Travel time = 1.39 min.
Time of concentration = 16.39 min.
Critical depth = 0.124(Ft.)
Adding area flow to channel
UNDEVELOPED (dense cover) subarea
Rainfall intensity = 2.228(In/Hr) for a 100.0 year storm
Subarea runoff = 0.813(CFS) for 3.650(Ac.)
Total runoff = 0.924(CFS) Total area = 4.130(Ac.)

+++++
Process from Point/Station 212.000 to Point/Station 213.000
**** IMPROVED CHANNEL TRAVEL TIME ****

Upstream point elevation = 726.000(Ft.)
Downstream point elevation = 570.000(Ft.)
Channel length thru subarea = 700.000(Ft.)
Channel base width = 2.000(Ft.)
Slope or 'Z' of left channel bank = 2.000
Slope or 'Z' of right channel bank = 2.000
Estimated mean flow rate at midpoint of channel = 1.542(CFS)
Manning's 'N' = 0.040
Maximum depth of channel = 2.000(Ft.)
Flow(q) thru subarea = 1.542(CFS)
Depth of flow = 0.150(Ft.), Average velocity = 4.477(Ft/s)
Channel flow top width = 2.599(Ft.)
Flow Velocity = 4.48(Ft/s)
Travel time = 2.61 min.
Time of concentration = 18.99 min.
Critical depth = 0.242(Ft.)
Adding area flow to channel
UNDEVELOPED (dense cover) subarea
Rainfall intensity = 2.097(In/Hr) for a 100.0 year storm
Subarea runoff = 1.160(CFS) for 5.530(Ac.)
Total runoff = 2.083(CFS) Total area = 9.660(Ac.)

+++++
Process from Point/Station 212.000 to Point/Station 213.000
**** CONFLUENCE OF MINOR STREAMS ****

Along Main Stream number: 2 in normal stream number 2
Stream flow area = 9.660(Ac.)
Runoff from this stream = 2.083(CFS)
Time of concentration = 18.99 min.
Rainfall intensity = 2.097(In/Hr)

Process from Point/Station 220.000 to Point/Station 221.000
**** INITIAL AREA EVALUATION ****

UNDEVELOPED (dense cover) subarea
Initial subarea data:
Equations shown use english units, converted if necessary to (SI)
Initial area flow distance = 919.000(Ft.)
Top (of initial area) elevation = 645.000(Ft.)
Bottom (of initial area) elevation = 636.000(Ft.)
Difference in elevation = 9.000(Ft.)
Slope = 0.00979 s(%)= 0.98
Manual entry of initial area time of concentration, TC
Initial area time of concentration = 18.900 min.
Rainfall intensity = 2.101(In/Hr) for a 100.0 year storm
Effective runoff coefficient used for area (Q=KCIA) is C = 0.100
Subarea runoff = 0.622(CFS)
Total initial stream area = 2.960(Ac.)

Process from Point/Station 221.000 to Point/Station 222.000
**** IMPROVED CHANNEL TRAVEL TIME ****

Upstream point elevation = 636.000(Ft.)
Downstream point elevation = 561.000(Ft.)
Channel length thru subarea = 178.000(Ft.)
Channel base width = 2.000(Ft.)
Slope or 'Z' of left channel bank = 2.000
Slope or 'Z' of right channel bank = 2.000
Manning's 'N' = 0.040
Maximum depth of channel = 2.000(Ft.)
Flow(q) thru subarea = 0.622(CFS)
Depth of flow = 0.073(Ft.), Average velocity = 3.984(Ft/s)
Channel flow top width = 2.291(Ft.)
Flow Velocity = 3.98(Ft/s)
Travel time = 0.74 min.
Time of concentration = 19.64 min.
Critical depth = 0.137(Ft.)

Process from Point/Station 222.000 to Point/Station 223.000
**** IMPROVED CHANNEL TRAVEL TIME ****

Upstream point elevation = 561.000(Ft.)
Downstream point elevation = 558.000(Ft.)
Channel length thru subarea = 370.000(Ft.)
Channel base width = 2.000(Ft.)

Slope or 'Z' of left channel bank = 3.000
 Slope or 'Z' of right channel bank = 3.000
 Estimated mean flow rate at midpoint of channel = 1.352(CFS)
 Manning's 'N' = 0.040
 Maximum depth of channel = 2.000(Ft.)
 Flow(q) thru subarea = 1.352(CFS)
 Depth of flow = 0.340(Ft.), Average velocity = 1.318(Ft/s)
 Channel flow top width = 4.039(Ft.)
 Flow Velocity = 1.32(Ft/s)
 Travel time = 4.68 min.
 Time of concentration = 24.32 min.
 Critical depth = 0.215(Ft.)
 Adding area flow to channel
 UNDEVELOPED (dense cover) subarea
 Rainfall intensity = 1.828(In/Hr) for a 100.0 year storm
 Subarea runoff = 1.271(CFS) for 6.950(Ac.)
 Total runoff = 1.893(CFS) Total area = 9.910(Ac.)

++++++
 Process from Point/Station 222.000 to Point/Station 223.000
 **** CONFLUENCE OF MINOR STREAMS ****

Along Main Stream number: 2 in normal stream number 3
 Stream flow area = 9.910(Ac.)
 Runoff from this stream = 1.893(CFS)
 Time of concentration = 24.32 min.
 Rainfall intensity = 1.828(In/Hr)

Total of 3 streams to confluence:
 Flow rates before confluence point:
 5.543 2.083 1.893
 Area of streams before confluence:
 36.950 9.660 9.910
 Results of confluence:
 Total flow rate = 9.519(CFS)
 Time of concentration = 45.303 min.
 Effective stream area after confluence = 56.520(Ac.)

++++++
 Process from Point/Station 223.000 to Point/Station 223.000
 **** CONFLUENCE OF MAIN STREAMS ****

The following data inside Main Stream is listed:
 In Main Stream number: 2
 Stream flow area = 56.520(Ac.)
 Runoff from this stream = 9.519(CFS)
 Time of concentration = 45.30 min.
 Rainfall intensity = 1.291(In/Hr)
 Program is now starting with Main Stream No. 3

++++++
 Process from Point/Station 300.000 to Point/Station 301.000
 **** INITIAL AREA EVALUATION ****

UNDEVELOPED (dense cover) subarea
 Initial subarea data:
 Equations shown use english units, converted if necessary to (SI)
 Initial area flow distance = 758.000(Ft.)
 Top (of initial area) elevation = 1015.000(Ft.)
 Bottom (of initial area) elevation = 900.000(Ft.)
 Difference in elevation = 115.000(Ft.)
 Slope = 0.15172 s(%)= 15.17
 Manual entry of initial area time of concentration, TC
 Initial area time of concentration = 12.700 min.
 Rainfall intensity = 2.555(In/Hr) for a 100.0 year storm
 Effective runoff coefficient used for area (Q=KCIA) is C = 0.100
 Subarea runoff = 0.238(CFS)
 Total initial stream area = 0.930(Ac.)

++++
 Process from Point/Station 301.000 to Point/Station 302.000
 **** IMPROVED CHANNEL TRAVEL TIME ****

Upstream point elevation = 900.000(Ft.)
 Downstream point elevation = 815.000(Ft.)
 Channel length thru subarea = 578.000(Ft.)
 Channel base width = 2.000(Ft.)
 Slope or 'Z' of left channel bank = 3.000
 Slope or 'Z' of right channel bank = 3.000
 Estimated mean flow rate at midpoint of channel = 0.500(CFS)
 Manning's 'N' = 0.040
 Maximum depth of channel = 2.000(Ft.)
 Flow(q) thru subarea = 0.500(CFS)
 Depth of flow = 0.086(Ft.), Average velocity = 2.567(Ft/s)
 Channel flow top width = 2.517(Ft.)
 Flow Velocity = 2.57(Ft/s)
 Travel time = 3.75 min.
 Time of concentration = 16.45 min.
 Critical depth = 0.117(Ft.)
 Adding area flow to channel
 UNDEVELOPED (dense cover) subarea
 Rainfall intensity = 2.225(In/Hr) for a 100.0 year storm
 Subarea runoff = 0.456(CFS) for 2.050(Ac.)
 Total runoff = 0.694(CFS) Total area = 2.980(Ac.)

++++
 Process from Point/Station 301.000 to Point/Station 302.000
 **** CONFLUENCE OF MAIN STREAMS ****

The following data inside Main Stream is listed:
 In Main Stream number: 3
 Stream flow area = 2.980(Ac.)
 Runoff from this stream = 0.694(CFS)
 Time of concentration = 16.45 min.
 Rainfall intensity = 2.225(In/Hr)
 Program is now starting with Main Stream No. 4

++++

Process from Point/Station 400.000 to Point/Station 401.000
**** INITIAL AREA EVALUATION ****

UNDEVELOPED (dense cover) subarea
Initial subarea data:
Equations shown use english units, converted if necessary to (SI)
Initial area flow distance = 938.000(Ft.)
Top (of initial area) elevation = 815.000(Ft.)
Bottom (of initial area) elevation = 700.000(Ft.)
Difference in elevation = 115.000(Ft.)
Slope = 0.12260 s(%)= 12.26
Manual entry of initial area time of concentration, TC
Initial area time of concentration = 13.400 min.
Rainfall intensity = 2.477(In/Hr) for a 100.0 year storm
Effective runoff coefficient used for area (Q=KCIA) is C = 0.100
Subarea runoff = 0.483(CFS)
Total initial stream area = 1.950(Ac.)

+++++
Process from Point/Station 400.000 to Point/Station 401.000
**** CONFLUENCE OF MINOR STREAMS ****

Along Main Stream number: 4 in normal stream number 1
Stream flow area = 1.950(Ac.)
Runoff from this stream = 0.483(CFS)
Time of concentration = 13.40 min.
Rainfall intensity = 2.477(In/Hr)

+++++
Process from Point/Station 402.000 to Point/Station 403.000
**** INITIAL AREA EVALUATION ****

UNDEVELOPED (dense cover) subarea
Initial subarea data:
Equations shown use english units, converted if necessary to (SI)
Initial area flow distance = 631.000(Ft.)
Top (of initial area) elevation = 705.000(Ft.)
Bottom (of initial area) elevation = 686.000(Ft.)
Difference in elevation = 19.000(Ft.)
Slope = 0.03011 s(%)= 3.01
Manual entry of initial area time of concentration, TC
Initial area time of concentration = 14.300 min.
Rainfall intensity = 2.376(In/Hr) for a 100.0 year storm
Effective runoff coefficient used for area (Q=KCIA) is C = 0.100
Subarea runoff = 0.302(CFS)
Total initial stream area = 1.270(Ac.)

+++++
Process from Point/Station 402.000 to Point/Station 403.000
**** CONFLUENCE OF MINOR STREAMS ****

Along Main Stream number: 4 in normal stream number 2
Stream flow area = 1.270(Ac.)
Runoff from this stream = 0.302(CFS)

Time of concentration = 14.30 min.
Rainfall intensity = 2.376(In/Hr)

Total of 2 streams to confluence:
Flow rates before confluence point:

0.483 0.302

Area of streams before confluence:

1.950 1.270

Results of confluence:

Total flow rate = 0.785(CFS)

Time of concentration = 13.400 min.

Effective stream area after confluence = 3.220(Ac.)

Process from Point/Station 403.000 to Point/Station 403.000
**** CONFLUENCE OF MAIN STREAMS ****

The following data inside Main Stream is listed:

In Main Stream number: 4

Stream flow area = 3.220(Ac.)

Runoff from this stream = 0.785(CFS)

Time of concentration = 13.40 min.

Rainfall intensity = 2.477(In/Hr)

Total of 4 main streams to confluence:

Flow rates before confluence point:

14.069 9.519 0.694 0.785

Area of streams before confluence:

60.080 56.520 2.980 3.220

Results of confluence:

Total flow rate = 25.067(CFS)

Time of concentration = 23.614 min.

Effective stream area after confluence = 122.800(Ac.)

End of computations, total study area = 122.800 (Ac.)

APPENDIX B

DESILTATION BASIN ANALYSES



**Attachment IV-1
Sizing Criteria Worksheets**

These worksheets are designed to assist municipal staff and development project proponents in sizing stormwater treatment controls. Figures used in the computations can be found at the back of these worksheets.

I. Type of Treatment Measure Proposed for Project

1. Does the treatment measure (or part of a series of measures) operate based on the volume of water treated (i.e., detains an amount of runoff for a certain amount of time to allow solids and pollutants to settle to the bottom)? (See Table 1 for examples.)

Yes No

*If Yes, continue to Section II.—Sizing for Volume-Based Treatment Controls on page 2.
If No, continue to next question.*

2. Does the treatment measure (or part of a series of measures) operate based on continuous flow of runoff through the device? (See Table 1 for examples.)

Yes No

If Yes, continue to Section III.—Sizing for Flow-Based Treatment Controls on page 8.

Table 1: Examples Of Volume-Based And Flow-Based Controls

Volume-based Controls	Flow-based Controls
Extended detention (dry) ponds	Vegetated swales
Wet ponds	Vegetated buffer strips
Infiltration trench	Media filters
Infiltration basin	Hydrodynamic separators
Bioretention areas	Wet vaults
Constructed wetlands	Other proprietary treatment devices

Attachment IV-1
Sizing for Volume-Based Treatment Controls

Section B — Sizing Volume-Based Treatment Controls based on the Adapted California Stormwater BMP Handbook Approach

The equation that will be used to size the BMP is:

$$\text{BMP Volume} = (\text{Correction Factor}) \times (\text{Unit Storage}) \times (\text{Drainage Area to the BMP})$$

Step 1. Determine the drainage area for the BMP, A = This is the largest area tributary to a desiltation basin.

Step 2. Determine the watershed impervious ratio, “i”, which is the amount of impervious area in the drainage area to the BMP divided by the drainage area, or the percent of impervious area in the drainage area divided by 100.

a) Estimate the amount of impervious surface (rooftops, hardscape, streets, and sidewalks, etc.) in the area draining to the BMP =

b) Calculate the watershed impervious ratio, i:

$$i = \text{amount of impervious area (acres)/drainage area for the BMP (acres)}$$

$$i = (\text{Step 2.a.})/(\text{Step 1}) = \text{ } \text{ (range: 0-1)}$$

$$\text{Percent impervious area} = i/100 = \text{ _____ } \%$$

Step 3. Determine from Figure 1 the mean annual precipitation (MAP_{site}) at the project site location: (see Section II. Step 4 for more explanation.)

$$\text{MAP}_{\text{site}} = \text{ } \text{ See Appendix A for Figure 1}$$

Step 4 Identify the reference rain gage closest to the project site from the following list and record the MAP_{gage}:

$$\text{MAP}_{\text{gage}} = \text{ }$$

Reference Rain Gages	Mean Annual Precipitation (MAP _{gage}) (in)
San Jose Airport	13.9
Palo Alto	13.7 <==
Gilroy	18.2
Morgan Hill	19.5

Attachment IV-1
Sizing for Volume-Based Treatment Controls

Section B—Adapted California Stormwater BMP Handbook Approach (continued)

Step 5 Determine the rain gage correction factor for the precipitation at the site using the information from **Step 3** and **Step 4**.

$$\text{Correction Factor} = \text{MAP}_{\text{site}} (\text{Step 3}) / \text{MAP}_{\text{gage}} (\text{Step 4})$$

$$\text{Correction Factor} = \boxed{1.61}$$

Step 6. Identify representative soil type for the BMP drainage area.

a) Identify from Figure 1, the soil type that is representative of the pervious portion of the project shown here in order of increasing infiltration capability:

Clay Sandy Clay Clay Loam

Silt Loam Loam See Figure 1 in Appendix A

b) Does the site planning allow for protection of natural areas and associated vegetation and soils so that the soils outside the building footprint are not graded/compacted?

If your answer is no, and the soil will be compacted during site preparation and grading, the soil's infiltration ability will be decreased. Modify your answer to a soil with a lower infiltration rate (e.g., Silt Loam to Clay Loam or Clay).

Modified soil type:

7. Determine the average slope for the drainage area for the BMP: %

8. Determine the unit basin storage volume from sizing curves.

a) Slope \leq 1%,

Use the figure entitled "Unit Basin Volume for 80% Capture, 1% Slope" corresponding to the nearest rain gage: Figure 2-A, B, C, or D for San Jose, Palo Alto, Gilroy and Morgan Hill, respectively. Find the percent imperviousness of the drainage area (see answer to **Step 2**, above) on the x-axis. From there, find the line corresponding to the soil type (from **Step 6**), and obtain the unit basin storage on the y-axis.

$$\text{Unit Basin Storage (UBS)}_{1\%} = \boxed{} \text{ (inches)}$$

b) Slope \geq 15%

Use the figure entitled "Unit Basin Volume for 80% Capture, 15% Slope" corresponding to the nearest rain gage: Figure 3-A, B, C, or D for San Jose, Palo Alto, Gilroy and Morgan Hill, respectively. Find the percent imperviousness of the drainage area (see answer to **Step 2**, above) on the x-axis. From there, find the line corresponding to the soil type (from **Step 6**), and obtain the unit basin storage on the y-axis.

$$\text{Unit Basin Storage UBS}_{15\%} = \boxed{0.01} \text{ (inches)}$$

Attachment IV-1
Sizing for Volume-Based Treatment Controls

Section B—Adapted California Stormwater BMP Handbook Approach (continued)

c) Slope > 1% and < 15%

Find the unit basin volumes for 1% and 15% using the techniques in **Steps 8a** and **8b** and interpolate by applying a slope correction factor per the following formula:

UBS_x = Unit Basin Storage of intermediate slope, x

$$UBS_x = UBS_{1\%} + (UBS_{15\%} - UBS_{1\%}) * (x-1) / (15\% - 1\%)$$
$$= (\text{Step 8a}) + (\text{Step 8b} - \text{Step 8a}) * (x-1) / (15\% - 1\%)$$

Unit Basin Storage volume = (inches)
(corrected for slope of site)

9. Size the BMP, using the following equation:

BMP Volume = Rain Gage Correction Factor * Unit Basin Storage Volume * Drainage Area

BMP Volume = (**Step 5**) * (**Step 8** unit storage) * (**Step 1** Drainage area) * 1 foot/12 in.

BMP Volume = 0.0781 acre-feet or 3,404 cubic feet

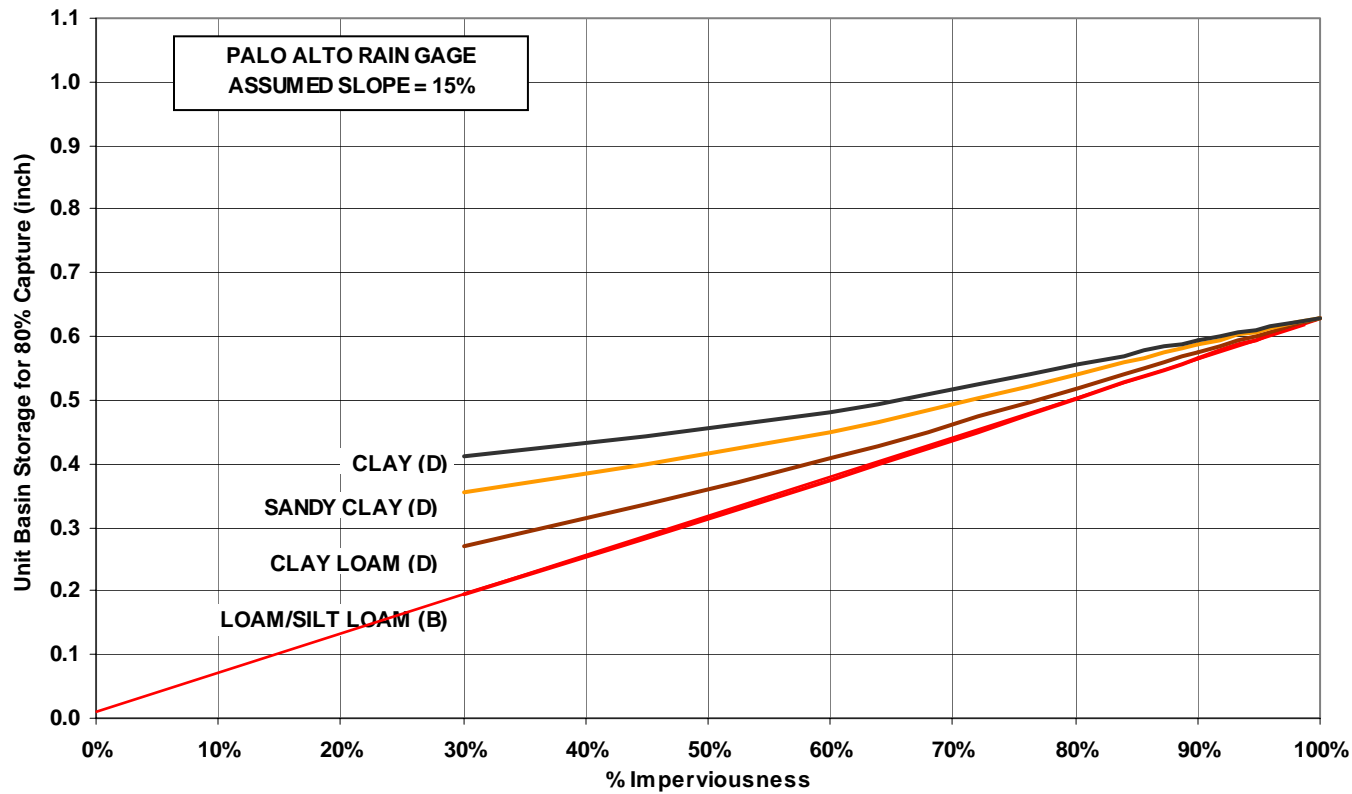
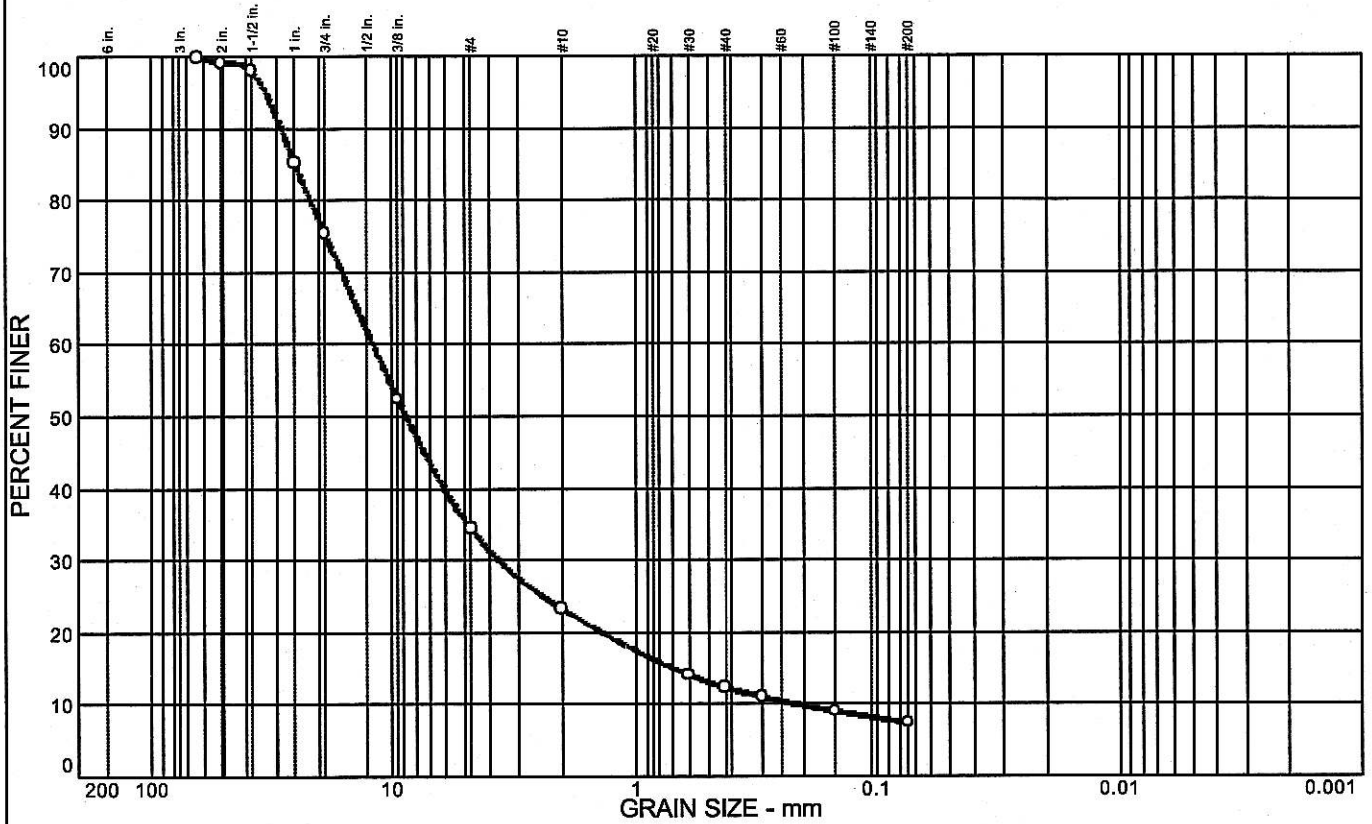


Figure 3-B Unit Basin Volume for 80% Capture - Palo Alto Rain Gage

EMSA - Proposed Desiltation Basin Sizing using SWRCB Equation

Proposed Condition				Minimum Basin	Minimum Basin
Rational Method Node	Area, ac	Q25, cfs	As, sf	Length, ft	Width, ft
104	58.24	11.0	2,129	65	33
206	36.95	4.5	871	42	21
213	9.66	1.7	329	26	13
223	9.91	1.5	290	24	12
302	2.98	0.6	116	15	8
401	1.95	0.4	77	12	6
403	1.27	0.2	39	9	4

Particle Size Distribution Report



% COBBLES	% GRAVEL	% SAND	% SILT	% CLAY	USCS	AASHTO	PL	LL
0	65.6	27.0	7.4					

SIEVE inches size	PERCENT FINER	
	o	
2.5	100.0	
2	99.2	
1.5	98.0	
1	85.3	
3/4	75.5	
3/8	52.4	
GRAIN SIZE		
D ₆₀	12.0	
D ₃₀	3.65	
D ₁₀	0.220	
COEFFICIENTS		
C _c	5.05	
C _u	54.84	

SIEVE number size	PERCENT FINER	
	o	
#4	34.4	
#10	23.3	
#30	14.1	
#40	12.4	
#50	11.0	
#100	9.0	
#200	7.4	

SOIL DESCRIPTION
 o Gray Poorly Graded GRAVEL w/ Silt & Sand

REMARKS:
 o

o Source: TC-1

WASTE ROCK - EMSA

COOPER TESTING LABORATORY	Client: Golder Associates Project: Hanson - 063-7109 Project No.: 287-036
----------------------------------	---

Figure

Worksheet for Weir for Risers

Project Description

Solve For Headwater Elevation

Input Data

Discharge	13.60	ft ³ /s
Crest Elevation	100.00	ft
Weir Coefficient	3.00	US
Crest Length	6.28	ft

Results

Headwater Elevation	100.80	ft
Headwater Height Above Crest	0.80	ft
Flow Area	5.05	ft ²
Velocity	2.69	ft/s
Wetted Perimeter	7.89	ft
Top Width	6.28	ft

Worksheet for Broad Crested Weir for Spillway

Project Description

Solve For Discharge

Input Data

Headwater Elevation		100.63	ft
Crest Elevation		100.00	ft
Tailwater Elevation		95.00	ft
Crest Surface Type	Gravel		
Crest Breadth		5.00	ft
Crest Length		10.00	ft

Results

Discharge		13.67	ft ³ /s
Headwater Height Above Crest		0.63	ft
Tailwater Height Above Crest		-5.00	ft
Weir Coefficient		2.73	US
Submergence Factor		1.00	
Adjusted Weir Coefficient		2.73	US
Flow Area		6.30	ft ²
Velocity		2.17	ft/s
Wetted Perimeter		11.26	ft
Top Width		10.00	ft

Worksheet for Desilt Basin Pipe

Project Description

Friction Method	Manning Formula
Solve For	Normal Depth

Input Data

Roughness Coefficient	0.013	
Channel Slope	0.01000	ft/ft
Diameter	2.00	ft
Discharge	13.60	ft ³ /s

Results

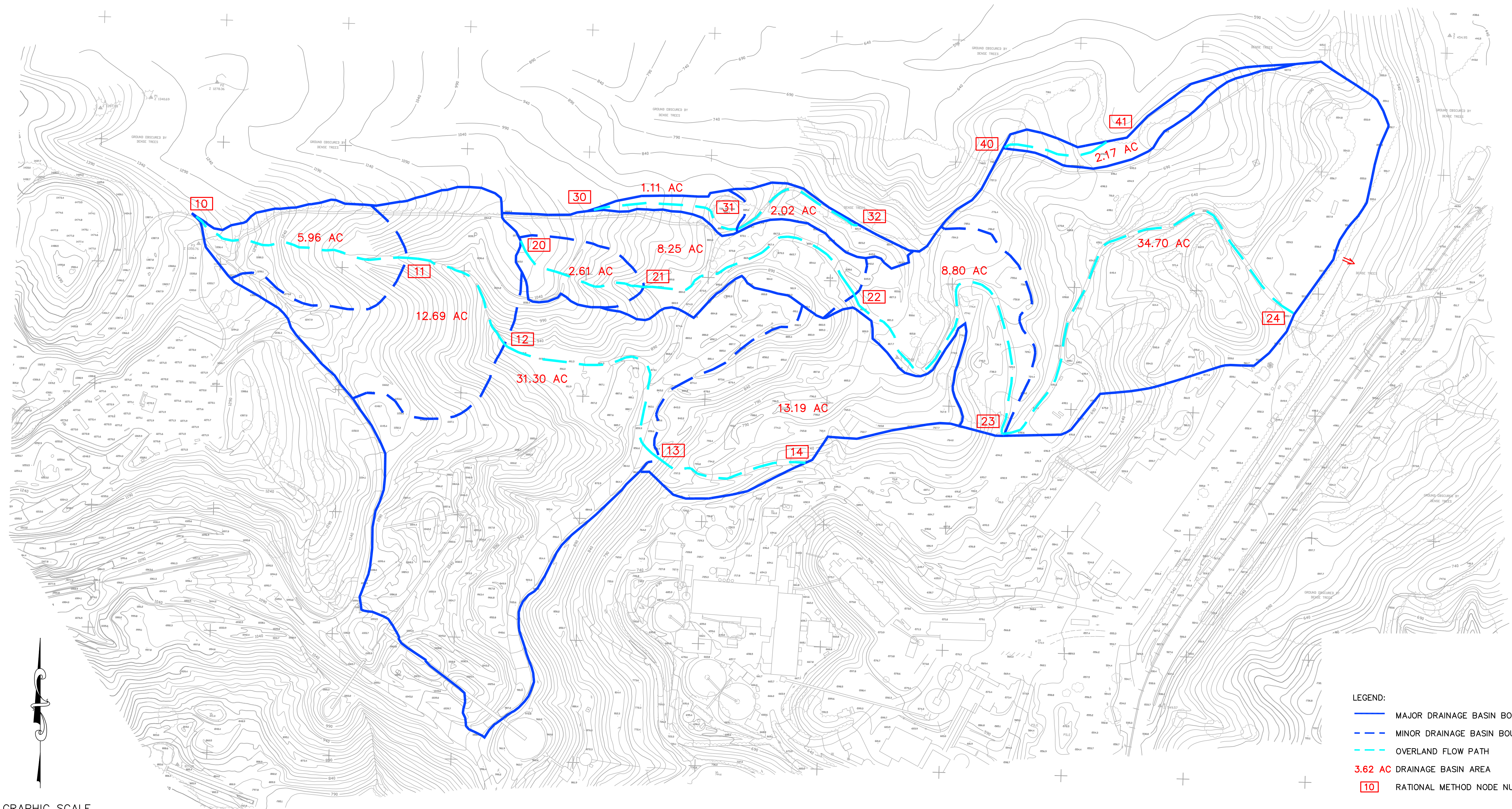
Normal Depth	1.12	ft
Flow Area	1.81	ft ²
Wetted Perimeter	3.38	ft
Hydraulic Radius	0.53	ft
Top Width	1.99	ft
Critical Depth	1.33	ft
Percent Full	55.9	%
Critical Slope	0.00595	ft/ft
Velocity	7.53	ft/s
Velocity Head	0.88	ft
Specific Energy	2.00	ft
Froude Number	1.39	
Maximum Discharge	24.33	ft ³ /s
Discharge Full	22.62	ft ³ /s
Slope Full	0.00361	ft/ft
Flow Type	SuperCritical	

GVF Input Data

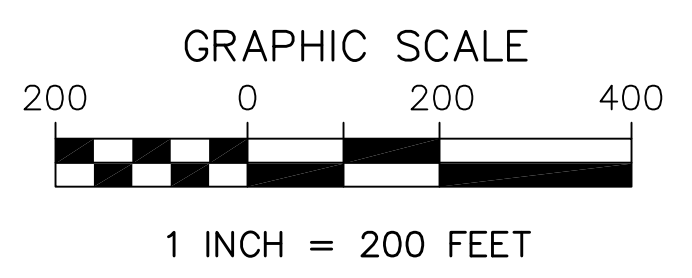
Downstream Depth	0.00	ft
Length	0.00	ft
Number Of Steps	0	

GVF Output Data

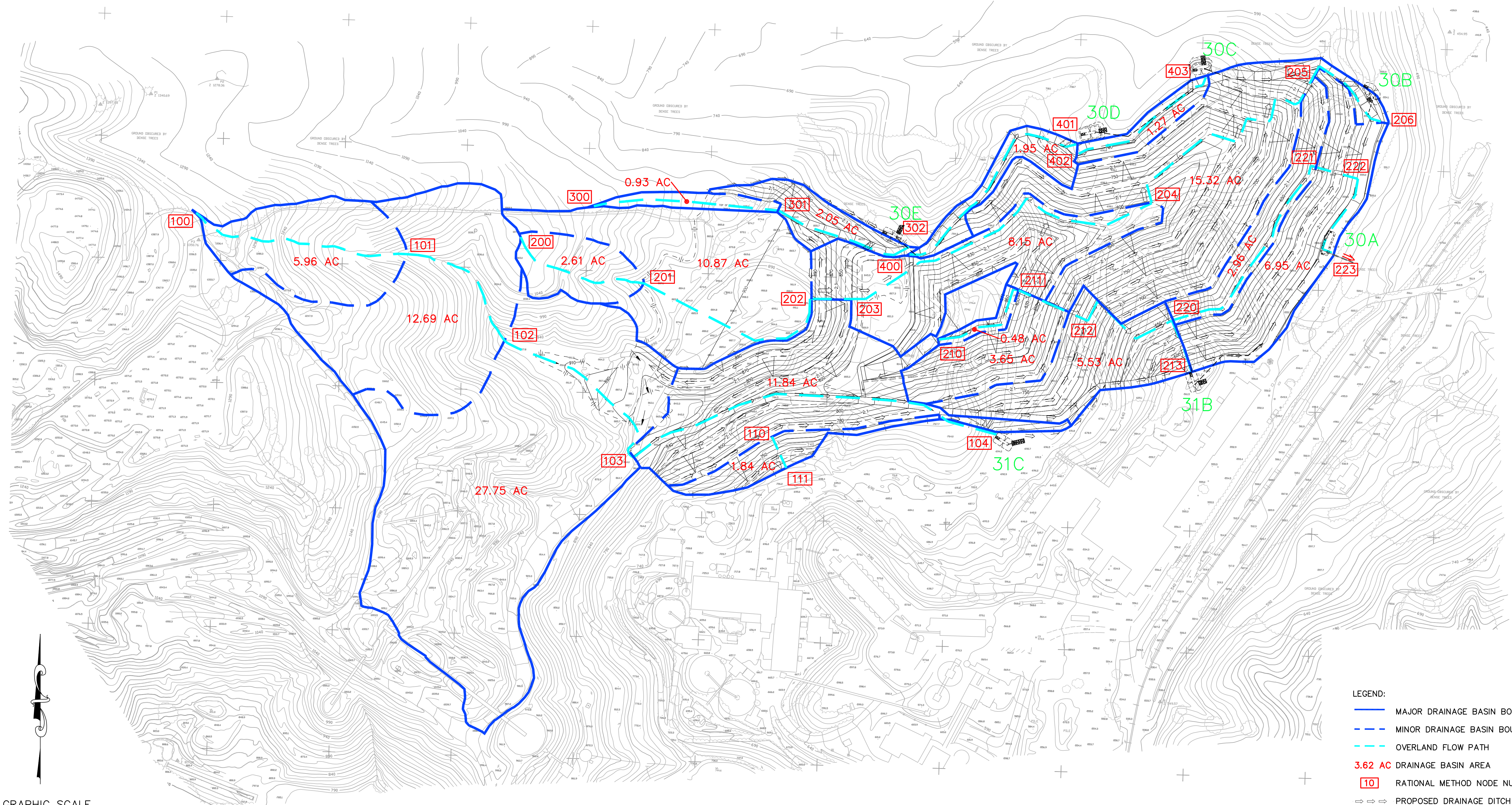
Upstream Depth	0.00	ft
Profile Description		
Profile Headloss	0.00	ft
Average End Depth Over Rise	0.00	%
Normal Depth Over Rise	55.90	%
Downstream Velocity	Infinity	ft/s



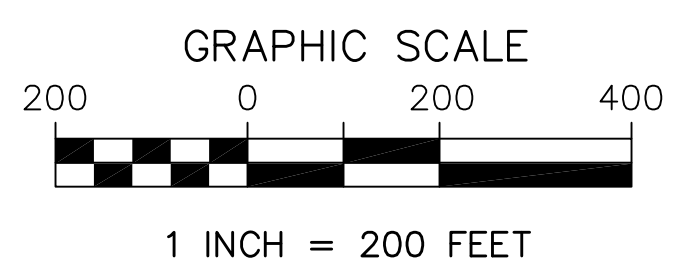
- LEGEND:
- MAJOR DRAINAGE BASIN BOUNDARY
 - - - MINOR DRAINAGE BASIN BOUNDARY
 - - - OVERLAND FLOW PATH
 - 3.62 AC DRAINAGE BASIN AREA
 - 10 RATIONAL METHOD NODE NUMBER



EXISTING CONDITION RATIONAL METHOD WORK MAP



- LEGEND:
- MAJOR DRAINAGE BASIN BOUNDARY
 - - - MINOR DRAINAGE BASIN BOUNDARY
 - - - OVERLAND FLOW PATH
 - 3.62 AC DRAINAGE BASIN AREA
 - 10 RATIONAL METHOD NODE NUMBER
 - ⇒ ⇒ ⇒ PROPOSED DRAINAGE DITCH
 - 30A PROPOSED DESILTATION BASIN



PROPOSED CONDITION RATIONAL METHOD WORK MAP

NOTE:
THE DESILTATION BASINS ARE TEMPORARY AND WILL BE REMOVED ONCE THE VEGETATION ESTABLISHES. THE HYDROLOGIC ANALYSES WERE BASED ON THE FINAL POST-RECLAMATION CONDITIONS.

Attachment G

Revegetation Test Plot Program As-Built Report

Revegetation Test Plot Program As-Built Report

PERMANENTE QUARRY
CUPERTINO, SANTA CLARA COUNTY
CALIFORNIA

Prepared For:

Lehigh Southwest Cement Company
24001 Stevens Creek Blvd.
Cupertino, CA 95014

Contact:

Mike Josselyn
josselyn@wra-ca.com

Geoff Smick
smick@wra-ca.com

Date:

April 2009



TABLE OF CONTENTS

1.0	INTRODUCTION	1
2.0	TEST PLOT DESIGN.....	1
2.1	Soil Treatments	1
2.2	Seed and Amendment Application	2
2.3	Planting	6
2.4	Variations from Test Plot Design and Specifications.....	7
3.0	MAINTENANCE.....	8
4.0	MONITORING AND ANALYSIS	8
4.1	Monitoring Program.....	8
4.2	Program Evaluation and Reporting	8
5.0	REFERENCES	9

APPENDICES

Appendix A – Report Figures:

- Figure 1. Test Plot Location Map
- Figure 2. Yeager Yard Test Plot Layout
- Figure 3. EMSA Test Plot Layout

Appendix B – Test Plot Photographs

Appendix C – Supporting Documentation for Test Plot Materials

LIST OF TABLES

Table 1.	Test plot soil treatments.....	3
Table 2.	Native shrub seed mix applied to all test plots.....	4
Table 3.	Grass and herbaceous seed mixes applied to test plot quadrants.	4
Table 4.	Erosion control seed mix (used in plot 14 only).	6
Table 5.	Mulch and hydroslurry application rates.	6
Table 6.	Preliminary list of trees and shrubs for planting in test plots.....	7

1.0 INTRODUCTION

This report presents the as-built conditions and maintenance and monitoring guidelines for a revegetation test plot program to assist in reclamation efforts at the Permanente Quarry (Quarry). The goals of the test plots are to assess the response of native seed mixes and container tree and shrub plantings to various soil conditions. Test plots provide the opportunity to investigate on a small scale what soil treatments and plant palettes will work best when the reclamation activities are fully implemented.

The California Code of Regulations Section 3705 (b) requires that test plots be implemented if a proposed revegetation plan has not been demonstrated to work in similar situations elsewhere (Newton and Claassen 2003). A test plot program has been established at the Quarry to determine appropriate materials and techniques to improve revegetation success throughout areas to be reclaimed. The specific objectives of the test plots are to assess the response of four different native seed mixes and a palette of restoration plantings to various soil treatment blends and depths, using several different materials available at the Quarry or from offsite.

Sixteen test plots were constructed on top of bare graded overburden rock at two different locations within the Quarry in the fall of 2008. Plots 1-12 and 16 were constructed at the relatively flat Yeager Yard site. Three additional temporary plots (13-15) were constructed at a sloped location within the East Materials Storage Area (EMSA). Test plot locations are shown in Figures 1 in Appendix A. Photographs of the test plots during construction are shown in Appendix B, and supporting documentation of some test plot construction materials can be found in Appendix C.

A five-year test plot monitoring program has been developed to evaluate the performance of each soil blend and planting palette, in order to inform future revegetation efforts.

2.0 TEST PLOT DESIGN

The test plot design is based on guidelines outlined in the "Test Plot Program" specifications (Hanson Permanente 2008). The basic test plot design is similar at both the Yeager Yard and EMSA sites. The border of each test plot was outlined by certified weed-free straw bales. At Yeager Yard, plots 1-12 are each 50-foot (ft.) by 50-ft. squares, and plot 16 is a 25-ft. by 25-ft. square. At the EMSA, temporary plots 13 and 14 are 100-ft. by 100-ft. squares, and temporary plot 15 is a slightly reduced size due to site constraints (100 ft. x 100 ft. x 100 ft. x 40 ft.).

To test the response of the seed mixes and plantings to various soil treatments, the test plots each differ by soil composition and depth of soil. The soil treatments consist of a combination of materials, including overburden rock, Pit 1 Fine Greenstone material, rock plant fines, and imported compost. Following application of the soil blends, each plot was divided into four quadrants of equal area using 6" certified weed-free straw wattles. Plots were numbered with a sign at the center of each plot. A stake was placed in the center of each plot quadrant and painted green, red, yellow, or blue to indicate the native seed mix applied to that quadrant. The test plot layouts at the Yeager Yard site and the EMSA are shown in Figures 2 and 3, respectively.

2.1 Soil Treatments

Test plot soil blends are comprised of various combinations of overburden rock, Pit 1 Fine Greenstone, and rock plant fines originating from the Quarry, as well as compost delivered from

offsite. A detailed report on soil sample analyses of these materials and potential blends is provided in the *Soil Development Plan for the East Materials Storage Area at Permanente Quarry* (WRA 2009). The soil treatments for all plots are listed in Table 1. Plots 1-6 are six inches in depth, plots 7-9 are 12 inches in depth, and plots 10-12 and 16 are 24 inches in depth. At the EMSA, plots 13, 14, and 15 are all six inches in depth.

Materials were dumped and blended together with construction equipment within each test plot to achieve a relatively uniform consistency. For the plots with multiple materials blended together, each material was added separately and then ripped or blended with the other material in sequence. The rock plant fines material included some consolidated chunks which required pulverizing before blending. Rocks over 6" in diameter were removed from the plots to the extent possible. The plots were compacted through normal heavy equipment activities to prevent erosion and were finish graded to a smooth surface.

2.2 Seed and Amendment Application

A native shrub mix was applied manually with a belly grinder to the entire area of all of the plots; the components of this mix are listed in Table 2. Four different native grass and herbaceous seed mixes were then applied manually with a belly grinder within the allocated quadrants of each plot. Components of the four native grass and herbaceous seed mixes for test plots are provided in Table 3. At plot 14, the Hanson Permanente native erosion control mix was mistakenly applied to the blue quadrant where Native Seed Mix #4 should have been; components of the erosion control mix are listed in Table 4. Following seeding at the test plots, straw mulch and a hydroslurry consisting of fertilizers and a tackifier was applied to all of the plots. At the EMSA site only, a mycorrhizal inoculant was included in the hydroslurry. The application rates of the straw and hydroslurry components are listed in Table 5.

Table 1. Test plot soil treatments.

PLOT NUMBER	PLOT SIZE	SOIL TREATMENT DEPTH	MATERIAL COMPONENTS	COMPONENT PROPORTIONS	COMPONENT DEPTH (before blending)
YEAGER YARD (flat)					
1	50' x 50'	6"	Overburden Rock	100%	6"
2	50' x 50'	6"	Overburden Rock Compost	75% 25%	4.5" 1.5"
3	50' x 50'	6"	Overburden Rock Compost	50% 50%	3" 3"
4	50' x 50'	6"	Overburden Rock Rock Plant Fines Compost	35% 40% 25%	2" 2.5" 1.5"
5	50' x 50'	6"	Pit 1 Fine Greenstone Compost	75% 25%	4.5" 1.5"
6	50' x 50'	6"	Overburden Rock Rock Plant Fines Pit 1 Fine Greenstone Compost	33% 17% 25% 25%	2" 1" 1.5" 1.5"
7	50' x 50'	12"	Overburden Rock Compost	75% 25%	9" 3"
8	50' x 50'	12"	Overburden Rock Pit 1 Fine Greenstone Compost	37.5% 37.5% 25%	4.5" 4.5" 3"
9	50' x 50'	12"	Overburden Rock Rock Plant Fines Pit 1 Fine Greenstone Compost	25% 25% 25% 25%	3" 3" 3" 3"
10	50' x 50'	24" ¹	Overburden Rock Compost	75% 25%	18" 6"
11	50' x 50'	24"	Pit 1 Fine Greenstone Compost	75% 25%	18" 6"
12	50' x 50'	24"	Overburden Rock Rock Plant Fines Pit 1 Fine Greenstone Compost	25% 25% 25% 25%	6" 6" 6" 6"
16	25' x 25'	24"	Overburden Rock Pit 1 Fine Greenstone Compost	37.5% 37.5% 25%	9" 9" 6"

¹ Compost in plot 10 was not blended uniformly per the specifications. As a result, this plot may be testing the placement of 6" of compost on top of overburden rock with little mixing. Soil depth will be confirmed during the first monitoring visit.

EMSA (sloped)					
13	100' x 100'	6"	Overburden Rock Compost	75% 25%	4.5" 1.5"
14	100' x 100'	6"	Overburden Rock Rock Plant Fines Compost	35% 40% 20%	2" 2.5" 1.5"
15	100' x 100' x 100' x 40'	6"	Pit 1 Fine Greenstone Compost	75% 25%	4.5" 1.5"

Table 2. Native shrub seed mix applied to all test plots.

SCIENTIFIC NAME	COMMON NAME	PURE LIVE SEED (lb / acre)
<i>Adenostoma fasciculatum</i>	chamise	1.50
<i>Artemisia californica</i>	California sagebrush	1.00
<i>Artemisia douglasiana</i>	mugwort	0.10
<i>Baccharis pilularis</i>	coyote brush	0.10
<i>Ceanothus cuneatus</i>	buckbrush	2.00
<i>Eriodictyon californicum</i>	yerba santa	0.50
<i>Eriogonum fasciculatum</i>	California buckwheat	1.50
<i>Heteromeles arbutifolia</i>	toyon	3.00
<i>Mimulus aurantiacus</i>	sticky monkeyflower	0.10
<i>Salvia mellifera</i>	black sage	1.00
TOTAL		10.80

Table 3. Grass and herbaceous seed mixes applied to test plot quadrants.

SCIENTIFIC NAME	COMMON NAME	PURE LIVE SEED (lb / acre)
Native Seed Mix #1 (green quadrant)		
<i>Achillea millefolium</i>	white yarrow	0.75
<i>Bromus carinatus</i>	California brome	8.00
<i>Clarkia pupurea</i> ssp. <i>quadrivulenera</i>	clarkia	0.75
<i>Elymus glaucus</i>	blue wildrye	6.50
<i>Heterotheca grandiflora</i>	telegraph weed	0.15
<i>Lotus purshianus</i>	Spanish clover	2.50
<i>Lotus scoparius</i>	deerweed	4.00
<i>Lupinus nanus</i>	sky lupine	1.50
<i>Nassella pulchra</i>	purple needlegrass	3.00
<i>Oenothera hookeri</i>	evening primrose	1.25
<i>Plantago erecta</i>	California plantain	2.50
<i>Vulpia microstachys</i>	three weeks fescue	4.00
TOTAL		34.90

Native Seed Mix #2 (red quadrant)		
<i>Bromus carinatus</i>	California brome	20.00
<i>Elymus glaucus</i>	blue wildrye	8.00
<i>Vulpia microstachys</i>	three weeks fescue	6.00
<i>Trifolium wildenovii</i>	tomcat clover	4.00
TOTAL		38.00
Native Seed Mix #3 (yellow quadrant)		
<i>Achillea millefolium</i>	white yarrow	1.00
<i>Bromus carinatus</i>	California brome	10.00
<i>Clarkia purpurea</i> ssp. <i>quadrivulnera</i>	clarkia	0.76
<i>Elymus glaucus</i>	blue wildrye	10.00
<i>Lotus purshianus</i>	Spanish clover	3.00
<i>Lotus scoparius</i>	deerweed	6.00
<i>Lupinus nanus</i>	sky lupine	3.00
<i>Oenothera hookeri</i>	evening primrose	2.00
<i>Vulpia microstachys</i>	three weeks fescue	4.00
TOTAL		39.76
Native Seed Mix #4 (blue quadrant)		
<i>Achillea millefolium</i>	yarrow	1.00
<i>Bromus carinatus</i>	California brome	9.00
<i>Elymus glaucus</i>	blue wildrye	8.00
<i>Eriogonum nudum</i>	naked buckwheat	0.25
<i>Eriophyllum confertiflorum</i>	golden yarrow	0.05
<i>Festuca occidentalis</i>	western fescue	6.00
<i>Leymus triticoides</i>	creeping wildrye	2.00
<i>Lotus purshianus</i>	Spanish clover	3.00
<i>Melica californica</i>	California melic	3.00
<i>Plantago erecta</i>	California plantain	3.00
<i>Poa secunda</i>	one-sided bluegrass	3.00
<i>Scrophularia californica</i>	beeplant	0.25
<i>Sisyrinchium bellum</i>	blue eyed grass	1.00
<i>Vulpia microstachys</i>	three weeks fescue	8.00
TOTAL		47.55

Table 4. Erosion control seed mix (used in plot 14 only).		
SCIENTIFIC NAME	COMMON NAME	PURE LIVE SEED (lb / acre)
<i>Bromus carinatus</i>	California brome	16.00
<i>Elymus glaucus</i>	blue wildrye	10.00
<i>Festuca rubra</i>	red fescue	8.00
<i>Lupinus nanus</i>	sky lupine (innoc.)	5.00
<i>Plantago erecta</i>	California plantain	3.00
<i>Trifolium wildenovii</i>	tomcat clover (innoc.)	3.00
<i>Vulpia microstachys</i>	three weeks fescue	8.00
TOTAL		53.00

Table 5. Mulch and hydrosolurry application rates.	
TREATMENT	APPLICATION RATE (lb / acre)
Weed-free sterile wheat straw mulch	4000
"Fiber Wood" organic mulch	2000
Plantago-based M-binder (tackifier)	200
42-0-0 Sulphur-coated urea	175
0-0-50 Sulfate "potash"	175
mycorrhizal inoculant (EMSA site only)	120

2.3 Planting

Planting of trees and shrubs in containers (or via acorns in the case of oaks) should take place in the test plots to mimic planned tree and shrub islands in revegetation areas. Planting will only take place in plots with 24-inch soil treatments (plots 10-12 and 16). Trees are to be planted on a minimum of 9-foot centers, with shrubs interspersed among the trees at 4.5-foot centers. Plantings will be concentrated in the center of the plots, so that a portion of each quadrant remains unplanted and hydroseed results can be observed. The tree and shrub plantings will occur over the first three years as on-site seed collection and/or nursery stock is available. Weed mats may be placed around planted trees and shrubs. Protective cages or fencing may be used if significant browse damage is observed.

Final species selection is currently in progress and installation will occur in early winter 2009-2010. Table 6 lists potential species for planting based on native species located in surrounding habitats and those that performed well in previous revegetation efforts.

Table 6. Preliminary list of trees and shrubs for planting in test plots. This list is based on current (March 2009) availability and potential to tolerate dry soils and a lack of irrigation.

SCIENTIFIC NAME	COMMON NAME
TREES – 3 of each species per test plot	
<i>Arbutus menziesii</i>	Pacific madrone
<i>Pinus sabiniana</i>	grey pine
<i>Quercus agrifolia</i>	coast live oak
<i>Quercus douglasii</i>	blue oak
SHRUBS* – 3 of each species per test plot (2 each in plot 16)	
<i>Cercocarpus betuloides</i>	mountain mahogany
<i>Heteromeles arbutifolia</i>	toyon
<i>Quercus berberidifolia</i>	scrub oak
<i>Rhamnus californica</i>	California coffeeberry
<i>Ribes californicum</i>	hillside gooseberry

* Shrub species selection may change based on the success of seeded shrubs. Establishment of the seeded species coyote brush, chamise, California sagebrush, buckbrush, and sticky monkeyflower will be evaluated in 2010. These species are expected to perform well in Quarry revegetation areas once an effective establishment method is identified. Therefore, if seeding is unsuccessful, these species may be installed as container plants in test plots in 2010.

2.4 Variations from Test Plot Design and Specifications

The test plots were built according to the Test Plot Program specifications developed by Hanson Permanente (2008) with the following exceptions:

- Due to space limitations, the dimensions of plot 15 are approximately 40' x 100' x 100' x 100' rather than a 100' square.
- It was observed that the soil materials were not uniformly blended in plot 10, as the compost appeared to be dumped on top of the overburden rock with little integration. The overburden rock beneath the compost may still be compacted; therefore the depth of the soil treatment may be closer to 6". This will be taken into account when analyzing the results of the test plot vegetation monitoring, and a soil sample will be observed to describe the condition and depth of organic material.
- The Hanson Permanente native erosion control mix was accidentally applied to the blue quadrant of plot 14. The amount of Native Seed Mix #4 designated for plot 14 was instead applied evenly to plots 13 and 15. Therefore plots 13 and 15 were seeded with 50% more of the mix than other plots.
- Seed Mix #3 was not applied to plot 16 as it was not included in the delivery from the seed company.

In addition, mychorrhizal inoculant was applied to EMSA plots but not to Yeager Yard plots.

3.0 MAINTENANCE

Maintenance of the test plots shall consist of inspection and replacement of herbivory protection materials as needed, weed control to limit the extent of noxious weeds, and repair of any damage to the straw bale barriers, labels, or other structures. Weed control should generally be conducted using the methods and level of effort as will be typical of larger reclamation areas, such as spot-application of herbicides, but may also be conducted using hand pulling and hand tools if feasible. Reseeding or replanting of trees and shrubs will only take place if low rainfall conditions or other unforeseen problems occur that would prevent the attainment of useful data from the study. All maintenance tasks and repeated treatments will be recorded in detail, specifying the plots in which the activity occurred.

4.0 MONITORING AND ANALYSIS

4.1 Monitoring Program

Sites should be monitored during years 1, 3, and 5 to determine the success of plant establishment and growth and re-establishment rates. Monitoring should occur in the late spring, beginning in 2009. Monitoring will be conducted by a qualified biologist with experience in plant identification. Any maintenance needs will be identified at the time of monitoring, and appropriate remedial actions will be recommended. Vegetation composition data will be collected for each plot quadrant as described below.

Tree and Shrub Plantings

Monitors will identify and count all trees and shrubs surviving in each plot quadrant. In addition, the canopy radius and total height of each tree and shrub will be estimated within approximately one-foot accuracy.

Hydroseed

Monitors will divide each plot quadrant into nine equal sections; each plot quadrant should be numbered consistently from 1 through 9 (for example, by always starting in the northeast corner of the quadrant). A random number generator will be used to select two sections within each plot quadrant for sampling. Within each selected section, one square-meter quadrat should be randomly dropped to sample vegetation data. Therefore, each plot quadrant will be sampled using two randomly placed sampling quadrats. Additional similarly-selected quadrats may be sampled if time is available.

Monitors will identify all species present in each sampling quadrat, estimate absolute percent cover of each species, and an overall percent cover of vegetation (or correspondingly, the percent cover of bare ground, litter, and/or thatch). Monitors should also wander each plot quadrant and list all other species present that may not have occurred in the sampling quadrats.

4.2 Program Evaluation and Reporting

Reports should evaluate the progress of test plot vegetation in meeting performance standards currently being developed for reclamation at the Quarry. During monitoring visits the test plot quadrants will be evaluated, at minimum, for native species cover, total percent cover, native species richness, and survival of plantings. The final Year 5 report should compare different seeding, soil treatment, and amendment strategies in terms of their ability to achieve the

performance criteria approved by the Office of Mine Reclamation (OMR), as well as in overall growth rate, survival, native composition, and native plant health. Notable differences in tree and shrub health, growth, and likely longevity among different soil treatments should also be specifically described.

5.0 REFERENCES

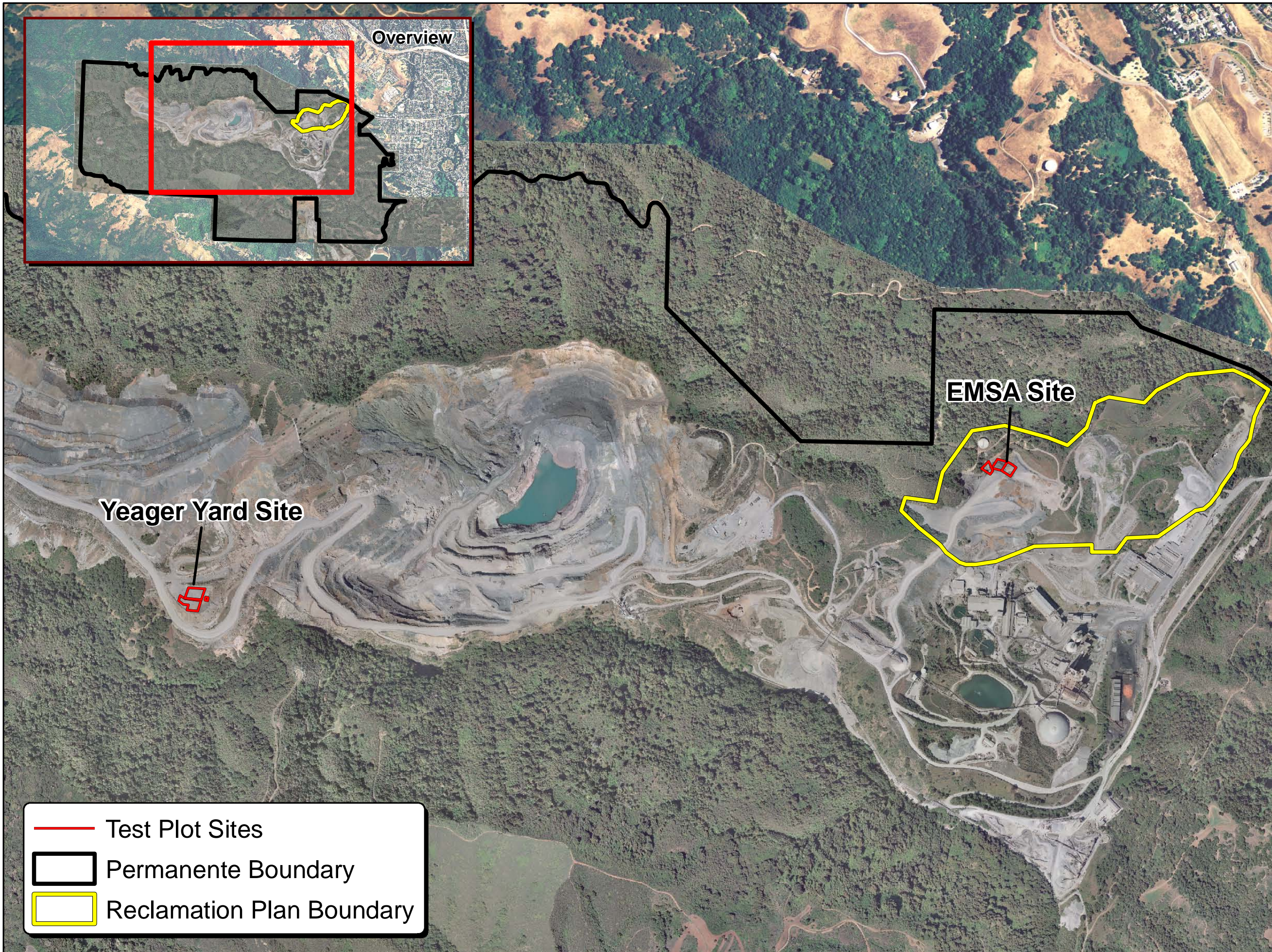
Hanson Permanente. 2008. Test plot program memo. Provided to WRA by Michael Meinen. October 12.

WRA, Inc. 2009. Soil Development Plan for the Permanente Quarry East Materials Storage Area, Cupertino, Santa Clara County, California.

APPENDIX A
REPORT FIGURES

East Materials Storage Area,
Lehigh Permanente Quarry,
Santa Clara County,
California

Figure 1.
Test Plot
Location Map



0 400 800 1,600
Feet

Date: April 2009
Map by: Michael Rochelle
Image Date: April 2007
File path: I:\Acad2000\16000\16143\gis\arcmap\
Soil Management Plan\Test Plots\
Test Plot Site.mxd

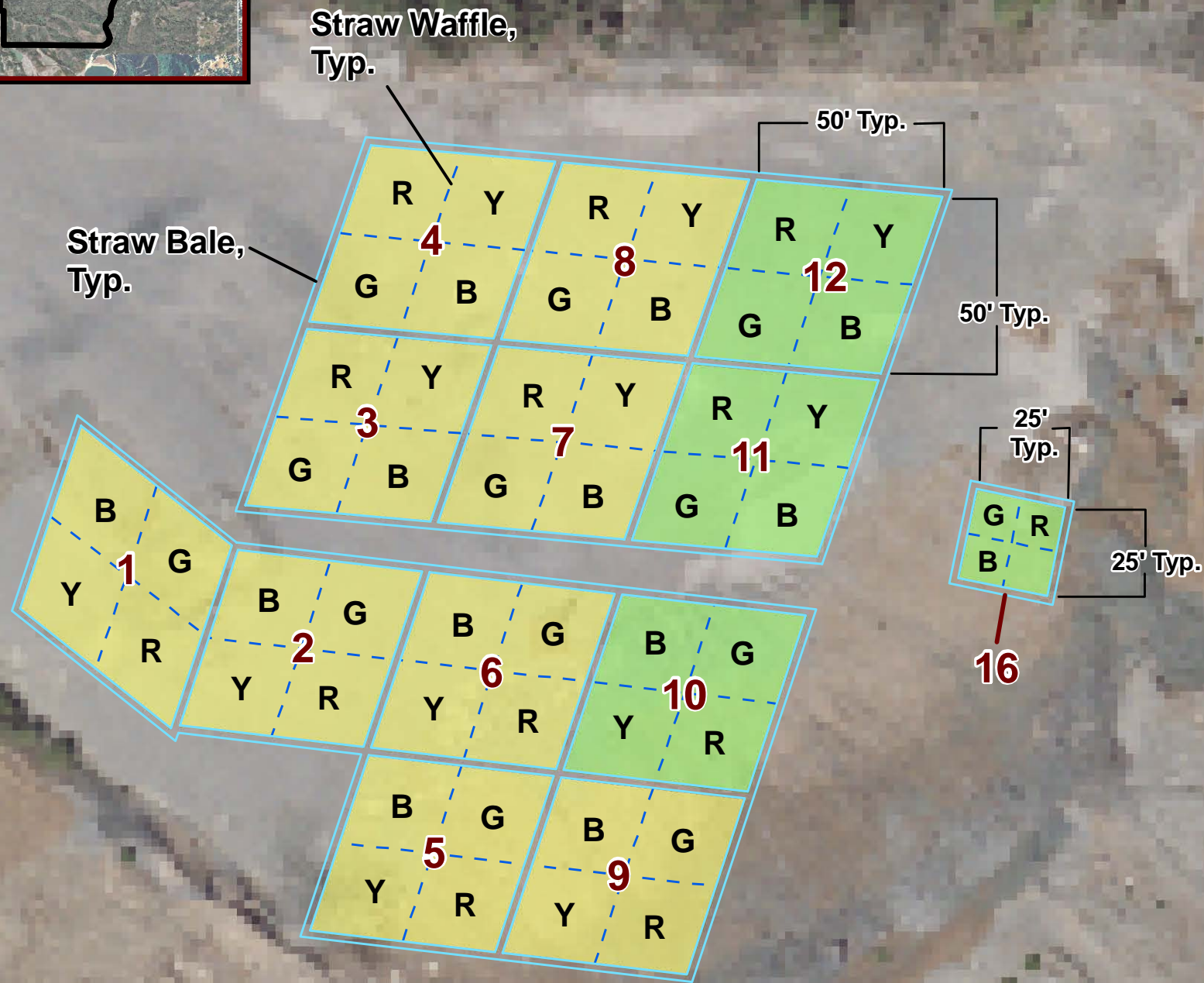
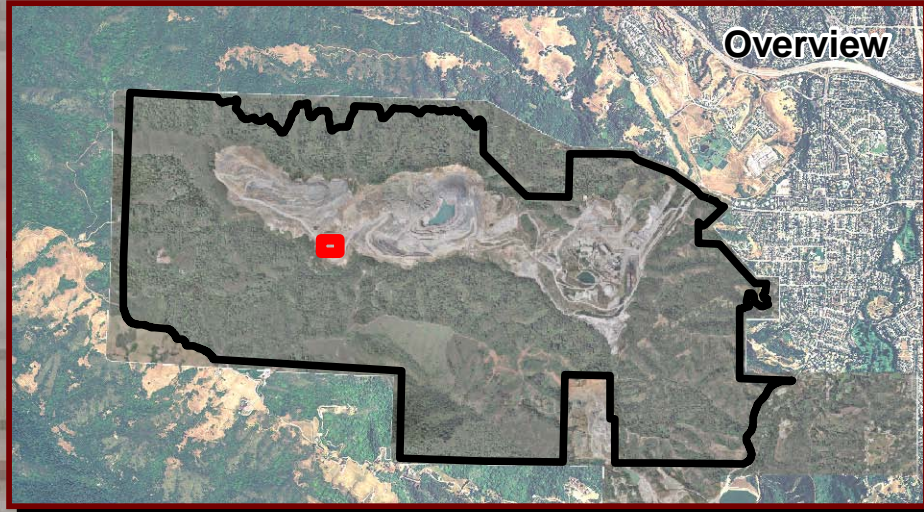
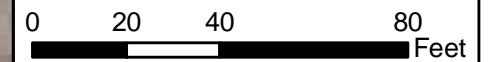
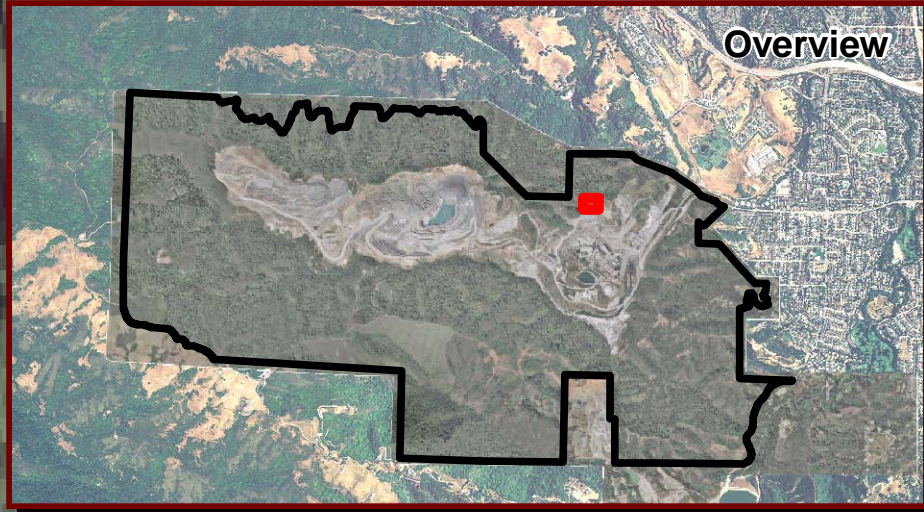


Figure 2.
Test Plot Layout
at Yeager Yard Site





East Materials Storage Area,
Lehigh Permanente Quarry,
Santa Clara County,
California

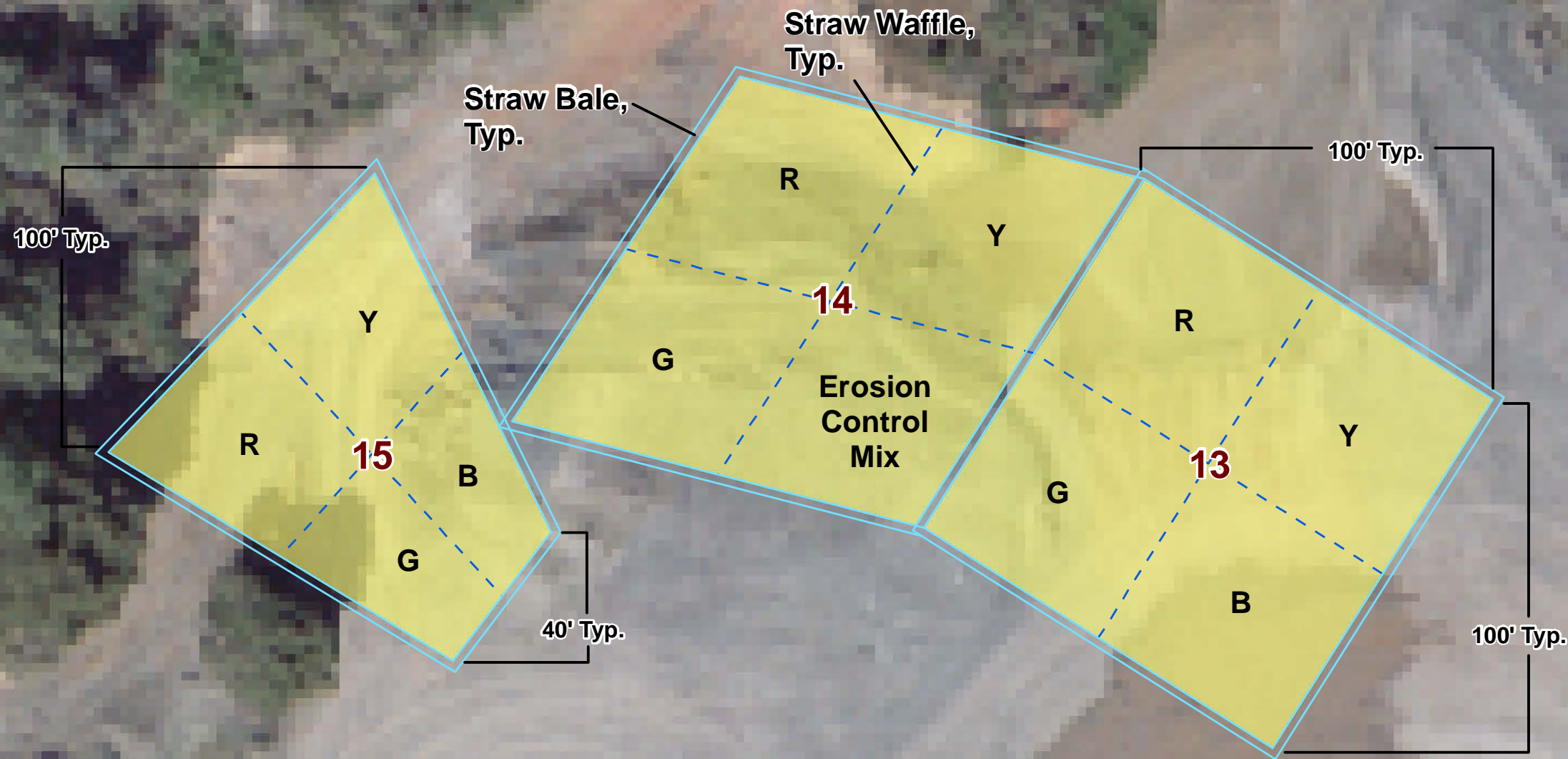
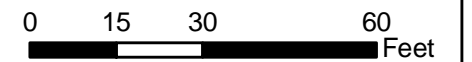


Figure 3.
Test Plot Layout
at EMSA Site



APPENDIX B
TEST PLOT PHOTOGRAPHS



Yeager Yard Test Plot Site



Top: Yeager Yard Test Plot Site

Bottom: EMSA Test Plot Site

Photographs taken October 21, 2008





Top: Test Plot Construction at Yeager Yard Site: Applying Compost
Bottom: Test Plot Construction at Yeager Yard Site: Blending Soil Materials

Photographs taken October 17, 2008





Top: Test Plot Construction: Applying Seed at the Yeager Yard site.

Bottom: Test Plot Construction: Blowing Straw at the EMSA site.

Photographs taken November. 18, 2008





Top: Test Plot Construction: Applying Hydroseed Slurry at EMSA site.

Bottom: Plot 14 at EMSA Site after Hydroseed Slurry Application

Photographs taken November 18, 2008



APPENDIX C
SUPPORTING DOCUMENTATION
FOR TEST PLOT MATERIALS



NAME: Lehigh Cement - Permanente tests

MIX: Native mix # 1 - Test Plot # 1 (green)

533 Hawthorne Place, Livermore, CA 94550 (925) 373-4417

NOTES: 34.90 pls lbs/acre

625 sf

PURITY	SPECIES	GERM	HARD	TOTAL
2.08	Achillea millefolium, Permanente Yarrow	80	0	80
22.81	Bromus carinatus, Santa Clara Cal Brome	77	0	77
1.85	Clarkia purp. ssp quad., Santa Clara Clarkia	92	0	92
15.71	Elymus glaucus, Santa Clara Blue Wildrye	91	0	91
0.94	Heterotheca grand., Perm. Telegraphweed	34	0	34
6.99	Lotus purshianus, NorCal Spanish Clover-inoc	79	0	79
10.57	Lotus scoparius, Santa Clara Deerweed - inoc	83	0	83
3.73	Lupinus nanus, Santa Clara Sky Lupine - inoc	89	0	89
7.82	Nassella pulchra, Permanente Purple Needlegrass	84	0	84
3.44	Oenothera hookeri, Santa Clara Evening Primrose	81	0	81
6.45	Plantago erecta, Santa Clara Plantain	85	0	85
9.22	Vulpia microstachys, Perm. 3 Weeks Fescue	95	0	95

This bag contains .50 pls lbs

CROP: 0.75 INERT: 7.37 WEED: 0.26 No Noxious Weed in CA
NET WT: 0.67 Lbs SELL BY: 10/09 TESTED: 7/08 ORIGIN: CA



NAME: Lehigh Cement - Permanente Test Plots

MIX: Native Mix # 2 - Test Plot # 1 (red)

533 Hawthorne Place, Livermore, CA 94550 (925) 373-4417

NOTES: 38.0 pls lbs/acre

625 sf

PURITY	SPECIES	GERM	HARD	TOTAL
53.77	Bromus carinatus, Santa Clara Cal Brome	77	0	77
18.20	Elymus glaucus, Santa Clara Blue Wildrye	91	0	91
13.09	Vulpia microstachys, Perm. 3 Weeks Fescue	95	0	95
8.79	Trifolium wildenovii, Alameda Tomcat Clover-inoc	94	0	94

This bag contains .55 pls lbs

CROP: 1.11 INERT: 4.66 WEED: 0.37 No Noxious Weed in CA
NET WT: 0.70 Lbs SELL BY: 10/09 TESTED: 7/08 ORIGIN: CA



NAME: Lehigh Cement - Permanente Test Plots

MIX: Native Mix # 3 - Test Plot #1 (yellow)

533 Hawthorne Place, Livermore, CA 94550 (925) 373-4417

NOTES: 36.75 pls lbs/acre

625 sf

PURITY	SPECIES	GERM	HARD	TOTAL
2.43	Achillea millefolium, Perm. White Yarrow	80	0	80
25.15	Bromus carinatus, Santa Clara Cal Brome	77	0	77
1.63	Clarkia purp. Ssp quad., Santa Clara Clarkia	92	0	92
21.27	Elymus glaucus, Santa Clara Blue Wildrye	91	0	91
7.39	Lotus purshianus, NorCal Spanish Clover-inoc	79	0	79
13.98	Lotus scoparius, Santa Clara Deerweed - inoc	83	0	83
6.52	Lupinus nanus, Santa Clara Sky Lupine -inoc	89	0	89
4.79	Oenothera hookerii, Santa Clara Evening Primrose	81	0	81
8.12	Vulpia microstachys, Perm. 3 Weeks Fescue	95	0	95

This bag contains .53 pls lbs

CROP: 0.99 INERT: 7.47 WEED: 0.27 No Noxious Weed in CA
NET WT: 0.75 Lbs SELL BY: 10/09 TESTED: 7/08 ORIGIN: CA



NAME: Lehigh Cement - Permanente Test Plots

MIX: Native mix # 4 - Test Plot # 1 (blue)

533 Hawthorne Place, Livermore, CA 94550 (925) 373-4417

NOTES: 47.55 pls lbs/acre

625 sf

PURITY	SPECIES	GERM	HARD	TOTAL
1.71	Achillea millefolium, Perm. White Yarrow	80	0	80
15.96	Bromus carinatus, Santa Clara Cal Brome	77	0	77
11.99	Elymus glaucus, Santa Clara Blue Wildrye	91	0	91
0.56	Eriogonum nudum, Foothill Naked Buckwheat	64	0	64
0.33	Eriophyllum confert., Santa Clara Gold Yarrow	25	0	25
19.49	Festuca occidentalis, NorCal Western Fescue	42	0	42
3.06	Leymus triticoides, NorCal Creep Wildrye	89	0	89
5.20	Lotus purshianus, NorCal Spanish Clover-inoc	79	0	79
4.44	Melica californica, Napa Cal Melic	92	0	92
4.80	Plantago erecta, Santa Clara Plantain	85	0	85
9.51	Poa secunda, Marin One-Side Bluegrass	43	0	43
0.56	Scrophularia cal. Santa Clara Beeplant	65	0	65
1.40	Sisyrinchium bellum, Santa Clara Blue-eyed Grass	97	0	97
11.49	Vulpia microstachys, Perm. 3 weeks Fescue	95	0	95

This bag contains 0.68 pls lbs

CROP: 0.51 INERT: 8.79 WEED: 0.22 No Noxious Weed in CA
NET WT: 1.06 Lbs SELL BY: 10/09 TESTED: 7/08 ORIGIN: CA



533 Hawthorne Place, Livermore, CA 94550 (925) 373-4417

NAME: Lehigh Cement - Permante Test Plots

MIX: Native Tree & Shrub mix # 5

NOTES: 10.80 pls lbs/acre 1/3 acre

<u>PURITY</u>	<u>SPECIES</u>	<u>GERM</u>	<u>HARD</u>	<u>TOTAL</u>
7.14	Adenostema fasciculatum, Monterey Chamise	28	0	28
2.42	Artemisia californica Monterey Cal Sage	55	0	55
0.25	Artemisia douglasiana, Santa Clara Mugwort	51	0	51
0.23	Baccharis pilularis, Monterey Coyote Bush	56	0	56
3.41	Ceanothus cuneatus, Foothill Buckbrush	78	0	78
0.86	Eriodictyon californica, Santa Clara Yerba Santa	77	0	77
13.33	Eriogonum fasciculatum, Alameda Cal Buckwheat	15	0	15
22.21	Heteromeles arbutifolia, Santa Clara Toyon		18	18
0.08	Mimulus aurantiacus, Santa Clara Sticky	85	0	85
2.90	Salvia mellifera, Santa Clara Blk Sage	46	0	46
This bag contains 3.62 pls lbs				

CROP: 0.00 INERT: 47.16 WEED: 0.00 No Noxious Weed in CA
NET WT: 25.14 Lbs SELL BY: 10/09 TESTED: 7/08 ORIGIN: CA



Solano County

501 TEXAS STREET

FAIRFIELD, CALIFORNIA 94533

(707) 784-1310
FAX (707) 784-1330

Jearl Howard
AGRICULTURAL COMMISSIONER
SEALER OF WEIGHTS AND MEASURES

CERTIFIED WEED FREE FORAGE PROGRAM RECORD OF FIELD INSPECTION

Name: Robben, Gene		DBA: Gene Robben Farms
Mailing Address: 8057 Runge Rd		Telephone: (707) 678-9430
City: Dixon	Zip: 95620	FAX Number: (707) 678-9378
Site Number: W4 & W5		Field Location: 1 mile south of Tremont Rd, 1/2 mile east of Sikes Rd
Crop: Wheat Straw		Crop cutting #: 1
Acres: 154		Proposed harvest date: 7/2/07
Estimated Yield (Tons): 300-350		Inspection date: 6/28/07
Total inspection time: 2.5 hours, 58 miles		Inspector signature:

Comments (PDR#, PDR results, observations):

Some weeds around the perimeter of the fields extend into the wheat. Notable weeds include Prickly Lettuce (*Lactuca serriola*), Cocklebur (*Xanthium strumarium*), Velvetleaf (*Abutilon theophrasti*), and Curly Dock (*Rumex crispus*). Some Perennial Peppergrass (*Lepidium latifolium*) was found on the south side of site W5. It is on the border of the field but does not extend into the wheat. Perennial Peppergrass is a B rated pest on the noxious weed list. There is a population of Sudangrass (*Sorghum bicolor*) in the southeast corner of site W5. It extends 30 to 50 feet into the wheat. Single plants of Prickly lettuce and Sudangrass are very sparsely scattered in both fields.

A 30 to 60 foot buffer must be maintained from field edges to be certifiable.

Follow up:

1. Field certifiable? <input checked="" type="checkbox"/> Yes <input type="checkbox"/> No	Certificate Number: 48-07-01	Date Issued: 6/29/07
2. Grower contacted with results (date/time): 6/29/07 11:00 am		
2a. Comments (e.g. grower is willing or not to certify under required conditions): Spencer Bei agreed to this condition on 6/29/07 at approximately 11:00 am.		
3. Results Faxed (date): 7/2/07		

ANALYTICAL CHEMISTS
and
BACTERIOLOGISTS
Approved by State of California

TEL: 831-724-5422
FAX: 831-724-3188
www.compostlab.com

SOIL CONTROL LAB

42 HANGAR WAY
WATSONVILLE
CALIFORNIA
95076
USA

CODE: Weed-compost
Account #: 8100608-1/1-479
Group: Oct.08 C #45
Reporting Date: October 28, 2008

BFI - The Recyclery @ Newby Island
1601 Dixon Landing Rd - Fl.2
Milpitas, CA 95035-8100
Attn: Mark Buntjer

Date Received: 15 Oct. 08
Sample Identification: October
Sample ID #: 8100608 - 1/1

WEED SEED TEST

Viable Weed Seed: Less than 2 / Liter

No viable weed seed detected in the sample submitted.

Analyst: Assaf Sadeh



Attachment H
Revegetation Plan

Revegetation Plan

Permanente Quarry - East Materials Storage Area

CUPERTINO, SANTA CLARA COUNTY
CALIFORNIA

Prepared For:

Lehigh Southwest Cement Company
24001 Stevens Creek Blvd.
Cupertino, CA 95014

Contact:

Mike Josselyn
josselyn@wra-ca.com

Geoff Smick
smick@wra-ca.com

Date:

April 2009



TABLE OF CONTENTS

1.0	INTRODUCTION	1
1.1	Revegetation Goals.....	1
1.2	Summary of Revegetation Tasks	2
2.0	EXISTING CONDITIONS.....	2
2.1	Native Soil Types	2
2.2	Climate	3
2.3	Vegetation	3
2.4	Previous Revegetation Sites	3
3.0	SOIL DEVELOPMENT.....	4
3.1	Reference Sites.....	5
3.2	Target Soil Characteristics	7
3.3	Available Materials	7
3.4	Soil Blends	9
3.5	Soil Preparation.....	10
3.5.1	Material Quantities.....	11
3.5.2	Overburden Rock Preparation.....	11
3.5.3	Topsoil Preparation	12
3.5.4	Organic Amendments and Mulches	12
3.5.5	Timing Restrictions and Recommendations	14
4.0	REVEGETATION.....	14
4.1	Hydroseeding	15
4.2	Trees and Shrubs.....	15
4.3	Timing	17
5.0	TEST PLOT PROGRAM.....	17
5.1	Test Plot Design and Soil Treatments.....	18
5.2	Seed and Amendment Application.....	18
5.2	Test Plot Plantings	21
6.0	MAINTENANCE	22
7.0	MONITORING.....	23
7.1	Installation Monitoring	23
7.2	Vegetation Monitoring	23
7.3	Performance Standards	24
7.4	Performance Standards for Weed Control	25
7.5	Adaptive Management	25
8.0	REFERENCES	26

APPENDICES

Appendix A – Photographs of Test Plots and Previous Revegetation Sites

Appendix B – List of Potential Native Plant Species for Permanente Quarry Revegetation

Appendix C – Revegetation Plan Figures

Figure 1. RPA Area Location Map

Figure 2. Proposed RPA Areas

Figure 3. Solar Radiation within the RPA Area

Figure 4. Soil Sample Location Map

Figure 5. Test Plot Location Map

Figure 6. Yeager Yard Test Plot Layout

Figure 7. EMSA Test Plot Layout

LIST OF TABLES

Table 1. Description and characteristics of soil samples	6
Table 2. Summary of soil blend test results	10
Table 3. Estimated available volumes of material for soil development.....	11
Table 4. Proposed topsoil application depths and volumes required to achieve designated depths.....	11
Table 5. Proposed erosion control seed mix.....	14
Table 6. Preliminary species for general slope hydroseeding.	15
Table 7. Preliminary list of trees and shrubs for planting on	17
Table 8. Test plot soil treatments.....	19
Table 9. Native shrub seed mix applied to all test plots.....	20
Table 10. Grass and herbaceous seed mixes applied to test plot quadrants.	20
Table 11. Mulch and hydroslurry application rates.	22
Table 12. Proposed 5-year performance standards for EMSA revegetation	24

1.0 INTRODUCTION

This Revegetation Plan has been prepared at the request of Lehigh Southwest Cement Company (Lehigh) for the Permanente Quarry (Quarry). This plan provides recommendations for the revegetation of an 88.9-acre area that Lehigh proposes to include in the Quarry's Reclamation Plan (RPA Area). The RPA Area and the property boundaries are shown in Figure 1. The recommendations in this plan are intended to comply with the requirements of the California Surface Mining and Reclamation Act (SMARA), Public Resources Code section 2710 et seq., and SMARA's reclamation standards at Code of Regulations, Title 14, section 3705 et seq. (Reclamation Standards).

The primary feature within the RPA Area is the East Material Storage Area (EMSA). The EMSA is an existing overburden storage area within the Quarry. The EMSA provides storage for overburden rock excavated during mining operations in other portions of the Quarry. Reclamation of the EMSA (Figure 2) will occur at elevations from 550 feet to 900 feet above sea level. Upon reclamation, overburden rock will be contoured at 2:1 slopes, interrupted at 40-foot intervals with 25-foot benches for slope stability. Reclamation of the EMSA will include revegetation with native species following the guidance set forth in the Reclamation Standards. Reclamation will occur in phases as overburden rock is received by the EMSA, with progressive revegetation of slopes and benches as the planned landforms are completed.

This plan includes a description of the following:

- Goals of the revegetation program;
- Important site characteristics that influence revegetation;
- Test plot program (constructed in 2008);
- Soil development and planting methods; and
- Performance standards.

Appendix A provides representative photographs of previous successful revegetation sites and of test plot construction. Appendix B lists potential suitable native plant species for revegetation of the RPA Area. Appendix C includes Figures 1-7 as referenced in this Revegetation Plan.

1.1 Revegetation Goals

The planned end use for the RPA Area is open space. As a result, vegetation reestablished should visually integrate with that present in the surrounding open space areas and/or provide for permanent soil protection. The surrounding areas are north-facing slopes with well-established oak woodland communities with scattered high meadows and dry south-facing slopes vegetated with chaparral and coastal scrub species.

Several forms of revegetation are currently underway and planned to continue at the Quarry. The ultimate goal for revegetation efforts in the RPA Area is native community restoration. This refers to the reclamation of disturbed lands to a self-sustaining community of native species as described in the Reclamation Standards. Interim erosion control planting may be used to provide temporary protection for disturbed areas until which time they may be reclaimed to their approved end use.

The goal of current RPA Area revegetation efforts for north-facing slopes is to mimic the high meadow communities present on the north-facing slopes of the surrounding areas with scattered "islands" of shrub and tree plantings on the benches that eventually will contribute to the regeneration of oak woodlands. For south-facing RPA Area slopes, the goal of revegetation is to mimic the brush communities present on south-facing slopes in the adjacent open space

areas by seeding native shrubs and grasses that will eventually contribute to the establishment of scrub communities.

1.2 Summary of Revegetation Tasks

The objective of this Plan is to provide native vegetative cover for final contours, thus controlling erosion and stabilizing slopes, using plant materials capable of self-regeneration without continued dependence on irrigation, soil amendments, or fertilizer in accordance with the Reclamation Standards. Revegetation will be sufficient to stabilize the surface against the effects of long-term erosion and is designed to meet the post-extractive land use objectives of the site. Hydroseeding of the finished slopes with a mixture of native grasses, herbaceous plants, and shrubs will provide surface cover and erosion control for the new slopes. Tree and shrub planting areas will be located on benches of the revegetation areas to encourage the long-term development of an oak savannah on north-facing slopes, or native scrub community on south-facing slopes. These communities will provide visual integration of the EMSA with the surrounding hillsides. This revegetation plan describes a test plot program, soil treatment and plant installation, maintenance and adaptive management guidelines, and verifiable monitoring standards to assure success of revegetation.

2.0 EXISTING CONDITIONS

2.1 Native Soil Types

The Soil Survey of Santa Clara Area California (USDA 1958) indicates that the RPA Area is primarily situated upon four soil series.

Soper gravelly loam, 35 to 50 percent slopes - A portion of the RPA Area is mapped as this soil type. The natural vegetation consists almost wholly of brush. Where the soils have been cultivated, moderate erosion has resulted in most places. The subsoils in most places are dense enough to retard drainage to a moderate degree.

Los Gatos-Maymen complex, stony soils, 50+ percent slopes - The western half of the RPA Area are mapped as this soil type. The natural vegetation is almost entirely a dense growth of brush, the chief value of which is watershed protection. The soils are underlain by hard but generally brown or shattered shale or sandstone that has undergone varying degrees of metamorphosis. Slopes are steep and stony and in most places rock outcrops are numerous.

Los Gatos clay loam, 20 to 35 percent slopes - This soil supports a natural cover of grass, trees and grass, or brush. A pocket of Los Gatos clay loam, moderately eroded, 20 to 35 percent slopes is mapped in the RPA Area, which differs from the above Los Gatos-Maymen complex description only in that the exposed soil is redder, shallower, and has few gullies.

Pit - This mapping unit consists of areas large enough to map where excavations have been made and where the original soil has been removed.

According to the soil survey (USDA 1958), the native soils of the Quarry area were subject to erosion and gulying, were generally quite shallow, and hosted a plant community almost wholly dominated by scrub. Since the soil survey was conducted, significant portions of the RPA Area were further disturbed and are presently dominated by overburden material placed there historically. Although quarry activities have disturbed some of the native soils in the past, previous successful restoration plantings near the RPA Area have shown that there is potential

to restore plant communities and soil characteristics to a state similar to that described before disturbance.

2.2 Climate

The Quarry lies within a semi-arid Mediterranean climate zone characterized by warm summer and mild winter temperatures with a substantial slope effect contributing to vegetative community differences on north- and south-facing slopes. Rainfall occurs mainly from November through April. Average annual rainfall is about 22 inches, however precipitation can range widely from year to year. On north-facing slopes, conditions are moister and less warm than on south-facing slopes as evidenced by the dramatic differences in vegetative communities found on north- versus south-facing slopes. The RPA Area will have both north-facing and south-facing slopes. Figure 3 depicts the variation in solar radiation at the ground surface within different areas of the RPA Area based on slope and aspect. The exposed slopes of the RPA Area may suffer relatively higher summer temperatures than would be expected for this region, at least during the initial years of vegetation establishment. Sparse vegetative cover will be less effective in reflecting and blocking sunlight than an established, dense cover of vegetation.

2.3 Vegetation

Vegetation in the EMSA has been described in the *Biological Resources Assessment for the Permanente Quarry East Materials Storage Area* prepared by WRA, Inc. (WRA 2009a). Approximately half of the EMSA was historically disturbed by quarry operations and other industrial activities dating to the late 1930's. According to the *Biological Resources Assessment*, a Northern Mixed Chaparral / Coast Live Oak Woodland community is presumably the natural community that once dominated the Quarry area, including the EMSA site. Most of the hillslopes surrounding the Quarry property are described as this community type. This biological community is a mosaic of south-facing dry rocky hillslopes with thin soils dominated by chaparral species and north-facing hillslopes and shaded ravines forested with an oak-dominated canopy.

Shrub species typical of the chaparral community on south-facing slopes include mainly native species: coyote brush (*Baccharis pilularis*), scrub oak (*Quercus berberidifolia*), buckbrush (*Ceanothus cuneatus*), California sagebrush (*Artemisia californica*), chamise (*Adenostoma fasciculatum*), toyon (*Heteromeles arbutifolia*), and poison oak (*Toxicodendron diversilobum*). On north-facing slopes, typical overstory species include coast live oak (*Quercus agrifolia*), California bay (*Umbellularia californica*), and California buckeye (*Aesculus californica*) with scattered valley oak (*Quercus lobata*), and blue oak (*Quercus douglasii*). The scrub species in the understory on north-facing slopes are typically coyote brush and poison oak.

2.4 Previous Revegetation Sites

Previous natural and focused revegetation efforts in the EMSA have occurred successfully. The cut slope above the present day "boneyard" is covered with a dense shrub community dominated by purple sage (*Salvia leucophylla*; see Appendix A). This may have been a focused revegetation effort or it could have been a natural colonization by this native species. The slope below the boneyard is adjacent to the quarry entrance and is vegetated with a variety of native and ornamental tree species, including olive (*Olea europaea*), Monterey pine (*Pinus radiata*), Deodar cedar (*Cedrus deodara*), and coast live oak. These slopes were graded during the construction of the previous administration building locations in 1941. Historic aerial photos from 1948 show young plantings in some of these areas that are currently covered with a dense layer of trees and shrubs.

Additionally, the former east dump was successfully revegetated per the 1985 Reclamation Plan (known as Area C in that plan). Native shrub species such as coyote brush and California buckwheat (*Eriogonum fasciculatum*) were used in that revegetation effort and currently dominate the area today (Appendix A).

While the methodology of the earliest revegetation efforts are unknown, more recent revegetation typically consisted of grading slopes to a final contour, hydroseeding with native grass species, and frequently planting at a low to moderate density with native shrubs and trees including coyote brush, chamise, and oaks from locally collected cuttings and acorns. The growing substrate was typically crushed overburden rock with little reclaimed topsoil. The most successful sites are primarily south-facing slopes currently dominated by 70 to 100 percent cover of native shrubs including California buckwheat, coyote brush, buckbrush, and California sagebrush.

Irrigation was utilized in some revegetated areas to encourage the establishment of planted trees and shrubs, and protective cages were installed around most plantings or groups thereof to reduce damage from deer browsing. Generally, these areas are dominated by an herbaceous layer of exotic and native grass species including wild oats, brome grasses, three weeks fescue (*Vulpia microstachys*), and Italian rye-grass (*Lolium multiflorum*).

3.0 SOIL DEVELOPMENT

Areas to be revegetated in the RPA Area consist primarily of overburden rock, which does not provide an ideal substrate for soil development and revegetation success. Slopes scheduled to undergo revegetation will be graded to a final contour no steeper than 2:1. Materials and amendments will then be added to the overburden rock surface to improve the substrate's texture, structure, and nutrient availability and to promote faster soil development. Where continuing overburden storage operations disturb native soils, topsoil will be harvested and moved directly to an area of active revegetation whenever possible. If the harvested soils must be stored for some time prior to use in revegetation, those soils will be stockpiled and clearly labeled. Harvested topsoil will be compacted as little as possible and will only be moved or worked when it is dry. Stockpiles of topsoil or other growth medium intended for use in revegetation efforts will be protected from erosion and weed establishment through the use of hydroseeding with a native erosion control mix and tackifiers, mulches, erosion control blankets, wattles, silt fences, or other soil protection measures.

Where mining activities have resulted in compaction of the soil, ripping, discing, or other means will be used in revegetation areas to establish a suitable root zone in preparation for planting. Where access roads, haul roads, or other traffic routes are to be revegetated, all roadbase materials shall be stripped from the road, the substrate shall be ripped or disced as needed to promote establishment of an appropriate root zone, a soil mix containing 25% topsoil or compost will be spread to promote plant growth, and the area will be revegetated.

To provide information on soil conditions for the EMSA soil development program, several soil samples were collected from the Quarry. The soil samples included a representative sample of the overburden rock which will be the underlying substrate throughout the RPA Area, as well as samples from 11 undisturbed reference sites, three existing revegetation sites, and six potential supplemental material sources (Figure 4).

The Soil and Plant Laboratory, Inc. in Santa Clara, California performed an analysis of the soil samples, including an assessment of the following characteristics:

- pH
- Total Exchangeable Cations
- Salinity
- Sodium
- Sulfate
- Sodium Adsorption Ratio (SAR) Value
- Boron
- Macronutrients (Nitrogen, Phosphate, Potassium, Calcium, Magnesium, Sulfur)
- Micronutrients (Iron, Manganese, Copper, Zinc)
- United States Department of Agriculture (USDA) Soil Textural Classification
- Organic Matter Content (Percent Dry Weight)

Maps of soil sample locations and detailed reports on the soil sample analyses are provided in the *Soil Development Plan for the East Materials Storage Area* (WRA 2009b). Additional samples were analyzed for other portions of the Quarry, as described in the *Soil Development Plan*. Table 1 outlines the primary characteristics of the soil samples and collection sites relevant to revegetation of the RPA Area.

3.1 Reference Sites

Soil conditions at the 11 undisturbed sites supporting native plant communities can serve as a reference for determining the requirements to achieve a suitable growth medium for native plants in the RPA Area. Existing revegetation sites can also provide information for targeting suitable soil conditions since these sites are underlain by a substrate similar to the RPA Area. The three revegetation sites sampled included the “East Pit”, “West Pit”, and “West Dump” sites. The three sites vary in age of installation and revegetation techniques and plant materials used.

EMSA Native Soil Sites

The "East Dump Native" soil sample was collected and analyzed in May 2008 while the other 10 samples were collected and analyzed in February 2009. Samples were taken from existing road cut banks and soil pits in the EMSA, within oak woodland, chaparral, and grassland vegetation communities. The samples vary in soil texture, organic matter content, and other characteristics (WRA 2009b). The organic matter content of the EMSA soil samples varies between 0.7 and 7.4 percent with an average content of 3.6 percent. The East Dump Native, C7, O7, and O5 samples have the most desirable topsoil characteristics given their favorable soil texture and adequate organic matter content. While sample O6 has relatively high organic matter content (5.5 percent), the soil texture is not favorable given the excessive gravel and coarse sand fractions. Samples O9, G4, C8, and C5 have suitable texture characteristics overall but lack suitable organic matter content. Samples G3 and C6 show relatively poor topsoil characteristics with a combination of poor soil structure and low organic matter content.

Table 1. Description and characteristics of soil samples				
SAMPLE MATERIAL	SAMPLE DESCRIPTION	DOMINANT PLANT COMMUNITY	ORGANIC MATTER (% DRY WEIGHT)	USDA SOIL CLASSIFICATION
Native Soil Samples				
East Dump Native	potential topsoil source	chaparral	7.4	Sandy loam
G3	potential topsoil source	grassland	0.7	Gravelly sandy clay loam
G4	potential topsoil source	grassland	2.2	Gravelly clay loam
C5	potential topsoil source	chaparral	2.4	Clay loam
C6	potential topsoil source	chaparral	2.5	Very gravelly sandy loam
C7	potential topsoil source	chaparral	3.5	Sandy clay loam
C8	potential topsoil source	chaparral	2.5	Clay loam
O5	potential topsoil source	oak woodland	7.1	Clay loam
O6	potential topsoil source	oak woodland	5.5	Gravelly sandy loam
O7	potential topsoil source	oak woodland	2.6	Sandy loam
O9	potential topsoil source	oak woodland	2.8	Clay loam
Revegetation Site Samples				
Reveg East Pit	disturbed site - revegetated	native shrub cover (70%) [California buckwheat, coyote brush]	4.8	Very gravelly sandy loam
Reveg West Pit	disturbed site - revegetated	non-native grass cover (90%), with scattered shrub/tree plantings	3.7	Very gravelly loam sand
Reveg Slope West Dump	disturbed site - revegetated	native and non-native grass cover (70%), with shrub/tree plantings	0.8	Very gravelly sandy loam
Overburden Rock	EMSA substrate	N/A	1.2	Gravelly sandy loam
Supplemental Material Resources				
Pit 1 fine greenstone	potential supplemental material	N/A	0.7	Very gravelly loamy sand
Rock Plant Fines	potential supplemental material	N/A	1.4	Clay loam
West Main Topsoil	potential supplemental material	N/A	0.5	Very gravelly sand

East Pit Revegetation Site

The East Pit revegetation site was planted in the 1980s, and the primarily south-facing slopes of the site are now dominated by grass and native brush species, including California buckwheat, coyote brush, buckbrush, and California sagebrush. The results of the soil analysis indicate that soil at the East Pit revegetation site has the highest organic matter content (4.8 percent) of the

three revegetation sites, an amount ample for supporting native vegetation (WRA 2009b). The soil texture has highly excessive gravels as well as coarse sands. A soil pit showed a relatively thick "O" horizon, or organic horizon, compared to the other two revegetation sites. Of the three revegetation sites where soil samples were taken, the East Pit site also supports the most established vegetation. Given the relatively high organic matter content of the soil and the well-established vegetation at the East Pit revegetation site, the soil characteristics at this site would be the most appropriate to target in the RPA Area.

West Pit Revegetation Site

The West Pit revegetation site was installed in the 1970s and currently the non-native grass wild oats (*Avena barbata*) dominates the site with broadly scattered plantings consisting of such species as Monterey cypress (*Cupressus macrocarpa*), ornamental pine (*Pinus* sp.), and blue elderberry (*Sambucus mexicana*). The soil conditions at the West Pit revegetation site show a slightly lower amount of organic matter (3.7 percent) than the East Pit site and a similarly high amount of gravel fractions and coarse sands.

West Dump Revegetation Site

Installed between 2002 and 2006, the West Dump revegetation site is less mature than the other two revegetation sites and correspondingly, the vegetation cover at this site is less dense. Hydroseeded grasses and shrub and tree plantings dominate these north-facing slopes. The soil has a relatively low amount of organic matter (0.8 percent) compared to the other two revegetation sites. A hydroseed slurry, including some compost, biosol fertilizer, mycorrhizal inoculant, and hydrostraw, was applied directly to the overburden rock in this revegetation effort.

3.2 Target Soil Characteristics

Based on the assessment of the native reference and revegetation sites, some recommendations can be made on the soil characteristics for the RPA Area which would likely support native plant communities. Critical factors to consider include soil texture and organic matter content in addition to soil chemistry and nutrient levels. The soil characteristics of the East Pit Revegetation site would be appropriate to mimic since it is a revegetation site with the most well-established vegetation. The soil conditions of the native reference sites provide better conditions as plant growth media; however, these conditions will be more difficult and less realistic to achieve than those at the revegetation sites since the RPA Area will be more similar to the previous revegetation sites.

Targeting a loamy soil texture with a low diversity of particle sizes (especially gravel and coarse sands) to the extent possible would be desired for the RPA Area to achieve adequate infiltration rates and an appropriate plant growth medium. The East Pit Revegetation site soil is classified as a Very Gravelly Sandy Loam, and while this soil type may include large, gravel-size particles which are not ideal for facilitating plant growth, it has enough smaller material and organic matter to support a chaparral vegetation community. The organic matter content of this site is 4.8 percent, and this amount is recommended as a minimum final target for RPA Area soil development.

3.3 Available Materials

Stockpiled EMSA topsoil will be incorporated directly with the overburden rock substrate to improve soil conditions in the RPA Area. Topsoil from the RPA Area will be harvested and stockpiled for reclamation of the EMSA. Woody plant material cut in the EMSA will be chipped and blended with the topsoil to increase the organic matter. Although there should be sufficient

topsoil harvested and stockpiled on-site for the revegetation efforts, additional materials may also be added such as Pit 1 fine greenstone and rock plant fines. The overburden rock substrate and potential soil materials which could be blended with the overburden rock are described below in more detail.

Overburden Rock

The results of the soil analysis for the representative overburden rock sample indicate that the overburden rock alone does not provide ideal conditions to support the desired native plant communities in the RPA Area. The particle size analysis shows that the USDA classification is a Gravelly Sandy Loam with a diverse distribution of particle sizes. With this varied distribution of particle sizes, the susceptibility to consolidation is high. Over time, particles of various sizes could lock into a consolidated state which could slow down water infiltration rates to an undesirable degree and could cause the soil to be impervious in places. The organic content (1.2 percent) of the overburden rock is low for supporting a native plant community. The pH level indicates slightly alkaline conditions and the natural lime content is considered high. The content of salinity, sodium, and boron is safely low and the Sodium Adsorption Ratio (SAR) value is acceptable. Available nitrogen and potassium are low, phosphorus is fair, and calcium, magnesium, and sulfate are well supplied. Iron, copper, manganese, and zinc occur at low levels (WRA 2009b).

According to the soils analysis, the coarse, diverse soil composition of the overburden rock is of concern given the high potential for consolidation to occur over time, resulting in a state impervious to air and water. Given its rocky texture and low organic content, the overburden rock would benefit from the addition of topsoil and/or organic amendments. Blending the overburden rock with harvested topsoil or some of the soil candidates available within the Quarry is a consideration for improving texture and nutrient content, and potential blends are described below.

EMSA Native Topsoil

The eleven topsoil samples described above represent native soil conditions found within the footprint of the EMSA RPA Area. Approximately 25,000 – 35,000 cubic yards of topsoil will be harvested and stockpiled within the RPA Area. Prior to removing the topsoil, existing trees and shrubs will be cut and chipped in place. This woody debris will be incorporated into the topsoil to increase the level of organic matter in the soil. The swelling of the topsoil after harvesting and incorporation of chipped plant material will result in up to a ten percent expansion of volume of topsoil available for reclamation purposes.

The soil texture, organic matter content, and other characteristics of the EMSA topsoil samples varied in quality, with four of the eleven samples having both adequate amounts of organic matter and suitable soil texture. However, available EMSA topsoil should be a priority material for use in RPA Area revegetation, as it will potentially also contain native seeds and microorganisms that can improve revegetation success. Lehigh will conserve stockpiled topsoil from other areas of the Quarry for use in reclaiming the areas where they originated.

Pit 1 Fine Greenstone

Pit 1 fine greenstone material may be harvested from a slope failure occurring in the quarry pit. This material contains coarse sands with excessive gravel content, and similar to the overburden rock material, the susceptibility to consolidation of this material is high. The infiltration rates are estimated at a slow 0.10 inches per hour and could be even slower when consolidated. Organic matter content is relatively low (0.7 percent). Pit 1 fine greenstone

material may improve soil texture conditions of the overburden rock but based on the low organic matter content, would provide little added value in nutrient availability or soil structural development to the overburden rock substrate.

Rock Plant Fines

The rock plant fines material is a byproduct of the rock processing activities at the quarry. It has a clay loam texture and contains a substantially greater amount of silt and clay compared to the overburden rock. The rock plant fines material has relatively low organic matter content (1.4 percent). Blending the rock plant fines material with the overburden rock may improve soil texture conditions. However, achieving a homogeneous blend with this material could prove problematic.

3.4 Soil Blends

Based on the soil analysis results, a suitable plant growth medium can be created in the RPA Area by placing supplemental materials on top of and/or incorporating them directly with the overburden rock and adding organic amendments (WRA 2009b). Nine different soil combinations were tested at the Soil & Plant Laboratory to gain information on the soil composition resulting from various blends of soil materials, overburden rock, and compost. In formulating the blends, the lab targeted 4.8 percent organic matter, the amount of organic matter found in the East Pit revegetation site soil sample. A summary of the soil blend results is listed in Table 2.

Nutrient values show improvement in overall fertility for all of the blends compared to the overburden rock alone, most often as a result of the nutrient rich compost addition. The organic matter content of 4.8 percent was achieved or surpassed for all of the test blends except one, which still had an adequate amount of organic matter for native plants. In general, adding about 25 percent compost on a volume basis would provide an appropriate amount of organic matter for establishment of native plants.

Excess sodium occurring in the compost used in the test blends contributed to elevated salinity and SAR values present in the test blend results which was not present in the soil samples tested alone. Evaluating the intended compost product prior to use is recommended to assure that salts are safely low. Elevated salinity in the soil could hinder seed germination and be toxic to seedlings.

The most favorable soil candidates are those with predominantly EMSA (East Dump) native material. Blending the overburden rock or Pit 1 fine greenstone material with the East Dump native topsoil results in soils with excellent fertility and organic content and creates the most promising plant growth media of the blends tested. The soil blends which include the East Dump native material do not need compost to achieve the target organic matter content level since they are well-supplied with organic matter. However, incorporating compost with the East Dump native material could enhance nutrient supply and improve soil infiltration; this measure may be necessary depending on the quantities of topsoil available.

Table 2. Summary of soil blend test results		
SOIL BLEND	ORGANIC MATTER (% DRY WEIGHT)	USDA SOIL CLASSIFICATION
1. Overburden Rock (73%); Compost (27%)	7.0	Very Gravelly Sandy Loam
2. Pit 1 fine greenstone (40%); Overburden Rock (20%); Rock Plant Fines (20%); Compost (20%)	4.0	Very Gravelly Sandy Clay Loam
3. Rock Plant Fines (41%); Pit 1 fine greenstone (35%); Compost (24%)	5.6	Very Gravelly Loam
4. Pit 1 fine greenstone (81%); Compost (19%)	5.1	Very Gravelly Sandy Loam
5. Pit 1 fine greenstone (43%); Overburden Rock (36%); Compost (21%)	8.5	Very Gravelly Sandy Loam
6. East Dump Native (68%); Overburden Rock (32%)	5.1	Very Gravelly Sandy Loam
7. East Dump Native (75%); Pit 1 fine greenstone (25%)	10.1	Very Gravelly Sandy Loam
8. Rock Plant Fines (50%); West Main Topsoil (28%); Compost (22%)	6.3	Very Gravelly Loam
9. Rock Plant Fines (46%); Compost (22%); Pit 1 fine greenstone (16%); West Main Topsoil (16%)	6.8	Very Gravelly Loam

The second best soil blends contain the rock plant fines material. While the rock plant fines material favorably increases silt and clay content of the coarser overburden rock, Pit 1 fine greenstone, West Main, and Pit #1 materials, producing homogeneous soil blends with these materials may prove to be logistically difficult. The rock plant fines material has a high moisture content and would have to be dried before it is incorporated with the other soil materials. In field conditions, the drying and consequent incorporation of this material may be time-consuming and its effectiveness unpredictable. It is recommended that results from test plots using the rock plant fines material be obtained before application on a large scale.

Soil blends utilizing the overburden rock, Pit 1 fine greenstone, West Main, and Pit #1 materials with only compost provide adequate conditions for native plant establishment although the soil texture may be coarser than desired. The current estimate of the volume of native topsoil to be harvested from the RPA Area is adequate for application at desired depths throughout the EMSA. However, other materials discussed above will be available to create soil treatment blends in future revegetation efforts or if topsoil harvest does not meet the expected quantities.

3.5 Soil Preparation

Soil preparation in the RPA Area will involve preparing the overburden rock as well as incorporating soil and topsoil materials, compost, and soil amendments as needed to provide suitable plant growth media for revegetation activities. Different soil treatments may be used for the various portions of the RPA Area, depending on the target plant community and general aspect of each area.

3.5.1 Material Quantities

The volumes of available resources will be a primary factor in determining the feasibility of the soil blends. The soil types and estimated available volumes are listed in Table 3.

Table 3. Estimated available volumes of material for soil development	
MATERIAL	VOLUME AVAILABLE (CUBIC YARDS)
Pit 1 fine greenstone	Unlimited
EMSA Native Topsoil	25,000-35,000
Rock Plant Fines	5,000 / year

The target planting substrate depth for 2:1 slopes in the RPA Area is six inches, a depth suitable to support most shrub and grass species to be seeded on the site. This includes a blend of four inches of overburden rock material with two inches of topsoil. The tree and shrub benches require a planting substrate of approximately 18 to 24 inches deep to support root establishment of the planted trees. This will include a blend of 75 percent overburden rock material and 25 percent topsoil (six inches). Planting benches that include a diverse assemblage of native tree species will generally be located on north-facing and east-facing benches, where temperatures will be most suitable to support trees. EMSA native topsoil is a priority material for blending with the overburden rock, and volume calculations indicate that there will be sufficient topsoil harvested and stored on-site for all reclamation activities. Currently proposed soil treatment volumes and depths for slopes and benches are listed in Table 4.

Table 4. Proposed topsoil application depths and volumes required to achieve designated depths. The volumes listed below include an expected 20 percent increase due to the addition of chipped woody debris and swelling of soil during harvest and transport.			
SLOPES		BENCHES*	
DEPTH	VOLUME	DEPTH	VOLUME
2"	15,800 cubic yards	6"	13,700 cubic yards

3.5.2 Overburden Rock Preparation

Overburden rock is the subgrade material at the RPA Area. Slopes scheduled to undergo restoration planting will be graded to a final contour no steeper than 2:1. The total surface area of slopes available for revegetation within the RPA Area will be approximately 50 acres. Additional areas available for planting, including benches and perimeter roads, will total approximately 30 acres. Prior to the incorporation of topsoil or compost, it may be beneficial to rip, disc, or otherwise break up the top six inches of the overburden rock substrate to loosen the material to facilitate seed and plant root establishment.

3.5.3 *Topsoil Preparation*

Topsoil will be harvested from appropriate areas within the RPA Area. General guidelines for harvesting and stockpiling topsoil are described below.

Prior to topsoil harvest, the sites will be cleared of woody vegetation and root balls using chainsaws and a portable excavator. Plant debris will be chipped in place and spread on the topsoil, so that this organic matter is blended with the topsoil during harvest. It is estimated that this added organic material and the swelling of the excavated topsoil will increase the volume of the topsoil to be stockpiled by approximately 20 percent.

Topsoil Stripping and Salvaging

Salvaging topsoil for reclamation helps assure productivity of reclaimed lands. Identifying topsoil locations and depth is important to securing appropriate topsoil in optimal locations. Topsoil depth can vary; for example, deep topsoil usually occurs in draws and valley floors and ridge tops have generally very shallow topsoil. Topsoil can be identified by color. Often topsoil has a brownish or dark earthtone color consistent with the color of the soil near the surface. When bright colored earth tones or distinct color change occurs, it usually means topsoil has ended. The topsoil resources onsite vary in composition, nutrient content, and depth. WRA has identified portions of the EMSA with suitable topsoil and described available depths and general condition. Topsoil salvage will be avoided in historically disturbed areas or active quarry areas containing poor topsoil.

Topsoil Stockpiling and Placement

After topsoil is stripped, it will be hauled and stored within the EMSA. If soil materials are to be harvested, moved, stored, or worked during the construction or mining phase, it is important that these activities occur when the soil materials are dry. In order to facilitate root growth of plants, the topsoil should be compacted as little as possible. This can be most easily avoided by working with the soil under dry conditions. Wet or damp soils are easily compacted and smeared and will be much less able to grow plants than if they were handled when dry. Bacterial and fungal spores and plant seeds are also in a resistant stage of their life cycle if the soil is dry and are more likely to survive the moving process.

The Topsoil Stockpile Area will be identified and well marked to avoid any unnecessary disturbance to the topsoil. In addition, relocating topsoil after it is stockpiled should be minimized. If topsoil is stored during the winter rainy season, erosion control measures may be necessary to protect the stockpile.

Upon completion of the overburden rock preparation, the topsoil with chipped plant material incorporated will be placed at the top of slopes and then spread downslope at a uniform depth. A small bulldozer or similar equipment will be used to rip and blend the soil materials as necessary. Topsoil will be track walked to stabilize the topsoil material, and then the surface will be scarified to allow for proper seed germination. Topsoil compaction will not be such that its ability to perform as a planting medium will be compromised. To the extent feasible, rocks and plant material in excess of four inches in greatest dimension should be removed from the topsoil.

3.5.4 *Organic Amendments and Mulches*

Organic amendments include materials such as compost and manure and provide a ready source of carbon and nitrogen to facilitate the presence of microorganisms in the soil, contributing to the essential soil nutrient cycling that facilitates plant growth. Bacteria, fungi, and

other microorganisms involved in decomposing organic material increase dramatically when materials such as compost are added to soils. Microorganisms break down the organic matter and in turn provide a supply of nutrients for higher plants.

As described above, existing plant material on topsoil harvest areas will be grubbed, chipped, and incorporated into the topsoil to be stockpiled. Additional potential organic amendments are described below.

Compost

Compost is derived from the biological decomposition of organic material, including such materials as grass and lawn clippings, food overburden, municipal solid overburden, and sewage sludge. Compost is known to enhance macronutrient fertility, improve soil structure, increase infiltration and moisture retention, and improve nutrient exchange capabilities of the soil. When topsoil is not available for use, compost is especially useful as an amendment to enhance soil structure and nutrient composition of the soil substrate. To ensure adequate quality of the compost, it should be certified with the Seal of Testing Assurance by the U.S. Composting Council.

Mycorrhizae Inoculants

Mycorrhizal fungi grow in beneficial association with plant roots in the soil and form unique structures known as mycorrhizae. The mycorrhizae play an important role in facilitating nutrient transfer from the soil to the plant roots. Mycorrhizal inoculants can be added to the soil to help provide the benefits of mycorrhizae; however, the effectiveness of such inoculants is not well established. To achieve the potential benefits of mycorrhizae, it is recommended that mycorrhizal inoculants or duff collected from vegetative litter at an adjacent site be installed in planting sites. Alternatively, the inoculants can be added to a hydroseed mix.

Slow-release Fertilizers

Fertilizers should be used sparingly on soils which support native plants. Since native plants are accustomed to drought conditions and low levels of nutrients in the soil, the use of fertilizers can promote the presence of exotic weeds which can outcompete native plants. The use of slow-release fertilizers can be suitable for native plants, however. Slow-release fertilizers release nutrients over a three-month to two-year period of time, providing the appropriate amount of nutrients for native plants. Installing slow-release fertilizer tablets in planting pits is recommended to provide a supplemental nutrient source for individual plants.

Mulch

Mulches include many different materials and can be applied on the soil surface or incorporated into the soil. Surface applications protect a site from erosion but do not have as much effect on soil composition as when they are incorporated into the soil. When incorporated, mulches can act as organic amendments, increasing organic matter content, moisture infiltration, and nutrient cycling. Materials such as straw and wood residues (wood chips, bark, and sawdust) are commonly used as mulch. Straw mulches can be blown on to the surface of the soil and secured with a tackifying agent following hydroseed application.

While wood residues such as chips, bark, and sawdust can provide cheap organic matter for soils, they may not stay in place adequately on steep slopes. A layer of two to three inches of bark mulch can be applied around individual tree and large shrub plantings to help exclude weeds, improve moisture retention, and add organic matter to the soil.

3.5.5 Timing Restrictions and Recommendations

Earthwork activities, including soil development work, should occur during the dry season. Topsoil and other soil materials should not be moved or handled when wet. Organic amendments should be applied shortly before seeding and planting, if possible, to ensure optimal microbial activity.

4.0 REVEGETATION

This section describes plant installation planned for the RPA Area, with an available revegetation area of approximately 72 acres. Revegetation will focus on returning the EMSA to a native plant dominated habitat similar to the surrounding natural areas with enhanced biological communities than currently exists onsite. Revegetation efforts will be implemented in stages following completion of each stage of overburden piling and contouring. These phases currently are scheduled to occur between 2009 and 2015, and may extend over a longer period depending on the rate of overburden storage and other operational factors. Planting and maintenance will be conducted using an adaptive management approach, since test plots were constructed in 2008 and will not produce a significant amount of data before some planting will be initiated within the RPA Area. Therefore, a preliminary erosion control stage may be incorporated prior to the revegetation tasks listed below. The native seed mix shown in Table 5 includes species that have proven successful in other revegetation efforts in the Quarry, and is recommended to provide erosion control and initial establishment of native grasses and herbaceous species until a more specific revegetation plan is developed based on test plot data and plant and seed availability.

Table 5. Proposed erosion control seed mix.		
SCIENTIFIC NAME	COMMON NAME	PURE LIVE SEED (lb / acre)
<i>Bromus carinatus</i>	California brome	16.00
<i>Elymus glaucus</i>	blue wildrye	10.00
<i>Lupinus nanus</i>	sky lupine (innoc.)	5.00
<i>Nassella pulchra</i>	purple needlegrass	8.00
<i>Plantago erecta</i>	California plantain	3.00
<i>Trifolium wildenovii</i>	tomcat clover (innoc.)	3.00
<i>Vulpia microstachys</i>	three weeks fescue	8.00
TOTAL		53.00

Appendix B provides an extensive list of native species observed in undisturbed portions of the Quarry, which may be or have previously been used in revegetation planting or seeding at the EMSA. Propagule availability, lead time needed for nursery production, and results of test plots will help to refine this list. The general theme of revegetation is to grow grasses, forbs, and shrubs on the slopes with trees added on the benches. The cooler north and east facing benches will support the most diverse tree plantings while the south facing benches will mostly contain grey pine which can tolerate more extreme conditions.

4.1 Hydroseeding

In the RPA Area, contoured surfaces will be covered with native grass, herbaceous, and shrub species via hydroseeding a homogenous slurry of mulch, fertilizer, seed, and a binding agent over the areas to be revegetated. Drainage ditches and access roads will be left bare until the completion of the stockpiling at which time the roads will be revegetated. Local seed suppliers have been working with Lehigh staff to develop an appropriate native seed mix for reclamation, and are testing several mixes in the test plots (see Section 5.0). Adaptive management will continue to be used in the future to determine what seed mixes and slurry amendments are most effective for achieving revegetation goals. A preliminary hydroseed mix of shrubs and grasses is shown in Table 6, which includes species known to thrive in undisturbed Quarry areas or known to perform well in previous revegetation areas. These species should be used, pending availability, for the earliest stages of the proposed reclamation project, until test plot results can be used to further refine and expand the species selection.

Table 6. Preliminary species for general slope hydroseeding.		
SCIENTIFIC NAME	COMMON NAME	Suitable aspect (different mixes may be utilized on north-facing [N] vs. south-facing [S] areas)
SHRUBS		
<i>Adenostoma fasciculatum</i>	chamise	S
<i>Artemisia californica</i>	California sagebrush	N and S
<i>Baccharis pilularis</i>	coyote brush	N and S
<i>Ceanothus cuneatus</i>	buckbrush	N and S
<i>Eriogonum fasciculatum</i>	California buckwheat	S
<i>Heteromeles arbutifolia</i>	toyon	N
<i>Mimulus aurantiacus</i>	sticky monkeyflower	N
<i>Salvia leucophylla</i>	purple sage	S
<i>Salvia mellifera</i>	black sage	S
GRASSES AND HERBS		
<i>Elymus glaucus</i>	blue wildrye	N and S
<i>Eschscholzia californica</i>	California poppy	N and S
<i>Heterotheca grandiflora</i>	telegraph weed	N and S
<i>Lotus scoparius</i>	deerweed	N and S
<i>Lupinus nanus</i>	sky lupine (innoc.)	N and S
<i>Nassella pulchra</i>	purple needlegrass	N and S
<i>Plantago erecta</i>	California plantain	N and S
<i>Vulpia microstachys</i>	three weeks fescue	N and S

4.2 Trees and Shrubs

The interslope benches will have deeper soils and will be planted with tree and shrub species. The north and east facing benches will support the greatest diversity of trees and shrubs since they have less solar radiation and less intense temperatures (Figure 3). These north-facing and east-facing benches will provide approximately 13.3 acres of available planting areas. A target quantity of approximately 975 oak trees is scheduled in these areas, in addition to other native

tree species. South-facing benches will generally be planted with shrubs, however, grey pine (*Pinus sabiniana*), a native tree species that is tolerant of very dry conditions, will also be used in these areas.

Trees and shrubs will be planted as container plants or acorns in the revegetation areas to encourage re-establishment of a vegetative community similar in structure to that of the surrounding areas. Plantings will occur on the benches where a deeper layer of soil treatment materials is applied to ensure adequate space for root development. These deeper soils with container plantings will be prepared on contoured benches, while slopes will be covered with shallower soils and hydroseeded. To the extent practicable, trees and shrubs to be planted will be obtained from seeds collected on-site or from local sources. At least 10% of the total restoration area will be planted in tree and/or shrub planting areas. Shrubs will be planted at approximately 4.5-foot spacing (680 shrubs per acre) and trees at 9-foot spacing (up to 170 trees per acre) in the designated areas.

The need for herbivory protection for specific species will be evaluated based on the results of test plots and early stages of the proposed reclamation project. Weed mats may be placed around planted trees to reduce competition with revegetation species.

The need for irrigation will be assessed during the test-plot monitoring program. By planting a large number of acorns without irrigation, hearty oak trees will be selected for increasing the chances of their survival. However, if monitoring of the early revegetation stages and test plots indicate significant losses of plant material that threatens achievement of performance criteria, the need for irrigation will be re-evaluated.

As with hydroseeding, adaptive management will be used to determine which tree and shrub species will be planted, the most effective spacing and location, and species to use in replacement plantings if necessary. A preliminary list of trees and shrubs to be planted on benches of the RPA Area is provided in Table 7. Species selection and numbers will depend on propagule collection and availability, as well as on test plot results.

Although no evidence of Sudden Oak Death (SOD) was observed in the RPA Area, the majority of oak trees in the RPA Area are foliar hosts of *Phytophthora ramorum*, the pathogen that causes SOD syndrome, including coast live oak and canyon live oak. Foliar hosts are thought to be an important component in spreading SOD as the pathogen can fruit (sporulate) within one to three days on infected foliage. Known or suspected hosts of *P. ramorum* are listed by the California Oak Mortality Task Force (COMTF 2008). While plantings will include some foliar hosts such as coast live oak, toyon, and California coffeeberry due to their predominance in adjacent natural areas, species not known to be susceptible to *P. ramorum* (such as Valley oak and blue oak) will be more heavily represented in plantings than in surrounding natural areas to reduce the susceptibility of the revegetation program.

Table 7. Preliminary list of trees and shrubs for planting on RPA Area benches.		
SCIENTIFIC NAME	COMMON NAME	Potential <i>P. ramorum</i> host?
TREES (may use acorns instead of container planting for some oaks)		
<i>Arbutus menziesii</i>	Pacific madrone	yes
<i>Pinus sabiniana</i>	grey pine	no
<i>Quercus agrifolia</i>	coast live oak	yes
<i>Quercus chrysolepis</i>	canyon live oak	yes
<i>Quercus douglasii</i>	blue oak	no
<i>Quercus lobata</i>	Valley oak	no
<i>Quercus wislizenii</i>	interior live oak	no
SHRUBS*		
<i>Cercocarpus betuloides</i>	mountain mahogany	no
<i>Heteromeles arbutifolia</i>	toyon	yes
<i>Quercus berberidifolia</i>	scrub oak	no
<i>Rhamnus californica</i>	California coffeeberry	yes
<i>Rhamnus crocea</i>	redberry	no
<i>Ribes californicum</i>	hillside gooseberry	no
<i>Ribes malvaceum</i>	chaparral currant	no

* Shrub species selection may change based on the success of seeded shrubs in test plots. Seeding of coyote brush, chamise, California sagebrush, buckbrush, and sticky monkeyflower will be evaluated in test plots in 2009-2010, and if seed germination and establishment success is poor, these species will be tested as container plants. These species are expected to perform well in Quarry revegetation areas once an effective establishment method is identified.

4.3 Timing

All hydroseeding should be performed and completed between September 1 and December 1 to take advantage of warm soil temperatures and winter rains for successful germination and establishment. Container planting should be performed during the winter season and completed by approximately the end of January to improve successful establishment.

5.0 TEST PLOT PROGRAM

The California Code of Regulations Section 3705 (b) requires that test plots be implemented if a proposed revegetation plan has not been demonstrated to work in similar situations elsewhere. A test plot program has been established at the Quarry to determine appropriate materials and techniques to improve revegetation success throughout areas to be reclaimed. The specific objectives of the test plots are to assess the response of native seed mixes and container tree and shrub plantings to various soil blends and depths, using the available materials evaluated as described in Section 3.0.

Sixteen test plots were constructed on top of bare graded overburden rock at two locations within the Quarry in the fall of 2008. Plots 1-12 and 16 were constructed at the relatively flat “Yeager Yard” site, and plots 13-15 were constructed at a sloped location within the EMSA (Figure 5). To test the response of the seed mixes and plantings to various soil treatments, the test plots each differ by soil composition and depth of soil. The soil treatments consist of a combination of materials, including overburden rock, Pit 1 fine greenstone material, rock plant fines, and imported compost. Each test plot was divided into four equal quadrants upon which four different native seed mixes were applied, followed by straw mulch and a hydrosurry of fertilizers and a tackifier. In addition, container plantings will be installed in the 24-inch depth test plots (10-12 and 16) at the Yeager Yard site in the following winter.

A five-year test plot monitoring program will evaluate the performance of each soil blend and planting palette over the course of several years, to inform future revegetation efforts.

5.1 Test Plot Design and Soil Treatments

The basic test plot design is similar at both the Yeager Yard and EMSA sites. The border of each test plot was outlined by certified weed-free straw bales. At Yeager Yard, plots 1-12 are each 50-foot (ft.) by 50-ft. squares, and plot 16 is a 25-ft. by 25-ft. square. At the EMSA, plots 13 and 14 are 100-ft. by 100-ft. squares, and plot 15 is a slightly reduced size due to site constraints (100 ft. x 100 ft. x 100 ft. x 40 ft.). The soil materials specific to each plot treatment were laid down and mixed onsite as described below.

Test plot soil blends are comprised of various combinations of overburden rock, Pit 1 fine greenstone, and rock plant fines originating from the Quarry, as well as compost delivered from offsite. The soil treatments for all plots are listed in Table 8. Plots 1-6 are six inches in depth, plots 7-9 are 12 inches in depth, and plots 10-12 and 16 are 24 inches in depth. At the EMSA site, plots 13, 14, and 15 are all six inches in depth.

The materials were dumped and blended together with construction equipment within each test plot to achieve a relatively uniform consistency. For the plots with multiple materials blended together, each material was added separately and then ripped or blended with the other material in sequence. The rock plant fines material included some consolidated chunks which required pulverizing before blending. Rocks over six inches in diameter were removed from the plots to the extent possible. The plots were compacted to approximately 90% and were finish graded to a smooth surface.

Following application of the soil blends, each plot was divided into four quadrants of equal area using six-inch certified weed-free straw wattles. Plots were numbered with a sign at the center of each plot. A stake was placed in the center of each quadrant and painted green, red, yellow, or blue to indicate the native seed mix applied to that quadrant. The test plot layouts at the Yeager Yard site and the EMSA are shown in Figures 6 and 7, respectively.

5.2 Seed and Amendment Application

A native shrub mix was applied manually with a belly grinder to all of the plots; the components of this mix are listed in Table 9. Four different native grass and herbaceous seed mixes were then applied manually with a belly grinder within the allocated quadrants of each plot. Components of these seed mixes are provided in Table 10. Following seeding at the test plots, straw mulch and a hydrosurry consisting of fertilizers and a tackifier was applied to all of the plots. At the EMSA site only, a mycorrhizal inoculant was included in the hydrosurry. The application rates of the straw and hydrosurry components are listed in Table 11.

Table 8. Test plot soil treatments.					
PLOT NUMBER	PLOT SIZE	SOIL TREATMENT DEPTH	MATERIAL COMPONENTS	COMPONENT PROPORTIONS	COMPONENT DEPTH (BEFORE BLENDING)
YEAGER YARD (flat)					
1	50' x 50'	6"	Overburden Rock	100%	6"
2	50' x 50'	6"	Overburden Rock Compost	75% 25%	4.5" 1.5"
3	50' x 50'	6"	Overburden Rock Compost	50% 50%	3" 3"
4	50' x 50'	6"	Overburden Rock Rock Plant Fines Compost	35% 40% 25%	2" 2.5" 1.5"
5	50' x 50'	6"	Pit 1 fine greenstone Compost	75% 25%	4.5" 1.5"
6	50' x 50'	6"	Overburden Rock Rock Plant Fines Pit 1 fine greenstone Compost	33% 17% 25% 25%	2" 1" 1.5" 1.5"
7	50' x 50'	12"	Overburden Rock Compost	75% 25%	9" 3"
8	50' x 50'	12"	Overburden Rock Pit 1 fine greenstone Compost	37.5% 37.5% 25%	4.5" 4.5" 3"
9	50' x 50'	12"	Overburden Rock Rock Plant Fines Pit 1 fine greenstone Compost	25% 25% 25% 25%	3" 3" 3" 3"
10	50' x 50'	24"	Overburden Rock Compost	75% 25%	18" 6"
11	50' x 50'	24"	Pit 1 fine greenstone Compost	75% 25%	18" 6"
12	50' x 50'	24"	Overburden Rock Rock Plant Fines Pit 1 fine greenstone Compost	25% 25% 25% 25%	6" 6" 6" 6"
16	25' x 25'	24"	Overburden Rock Pit 1 fine greenstone Compost	37.5% 37.5% 25%	9" 9" 6"
EMSA (sloped)					
13	100' x 100'	6"	Overburden Rock Compost	75% 25%	4.5" 1.5"
14	100' x 100'	6"	Overburden Rock Rock Plant Fines Compost	35% 40% 20%	2" 2.5" 1.5"
15	100' x 100' x 100' x 40'	6"	Pit 1 fine greenstone Compost	75% 25%	4.5" 1.5"

Table 9. Native shrub seed mix applied to all test plots.

SCIENTIFIC NAME	COMMON NAME	PURE LIVE SEED (lb / acre)
<i>Adenostoma fasciculatum</i>	chamise	1.50
<i>Artemisia californica</i>	California sagebrush	1.00
<i>Artemisia douglasiana</i>	mugwort	0.10
<i>Baccharis pilularis</i>	coyote brush	0.10
<i>Ceanothus cuneatus</i>	buckbrush	2.00
<i>Eriodictyon californicum</i>	yerba santa	0.50
<i>Eriogonum fasciculatum</i>	California buckwheat	1.50
<i>Heteromeles arbutifolia</i>	toyon	3.00
<i>Mimulus aurantiacus</i>	sticky monkeyflower	0.10
<i>Salvia mellifera</i>	black sage	1.00
TOTAL		10.80

Table 10. Grass and herbaceous seed mixes applied to test plot quadrants.

SCIENTIFIC NAME	COMMON NAME	PURE LIVE SEED (lb / acre)
Native Seed Mix #1 (green quadrant)		
<i>Achillea millefolium</i>	white yarrow	0.75
<i>Bromus carinatus</i>	California brome	8.00
<i>Clarkia pupurea</i> ssp. <i>quadrivulenera</i>	clarkia	0.75
<i>Elymus glaucus</i>	blue wildrye	6.50
<i>Heterotheca grandiflora</i>	telegraph weed	0.15
<i>Lotus purshianus</i>	Spanish clover	2.50
<i>Lotus scoparius</i>	deerweed	4.00
<i>Lupinus nanus</i>	sky lupine	1.50
<i>Nassella pulchra</i>	purple needlegrass	3.00
<i>Oenothera hookeri</i>	evening primrose	1.25
<i>Plantago erecta</i>	California plantain	2.50
<i>Vulpia microstachys</i>	three weeks fescue	4.00
TOTAL		34.90
Native Seed Mix #2 (red quadrant)		
<i>Bromus carinatus</i>	California brome	20.00
<i>Elymus glaucus</i>	blue wildrye	8.00
<i>Vulpia microstachys</i>	three weeks fescue	6.00
<i>Trifolium wildenovii</i>	tomcat clover	4.00
TOTAL		38.00
Native Seed Mix #3 (yellow quadrant)		
<i>Achillea millefolium</i>	white yarrow	1.00
<i>Bromus carinatus</i>	California brome	10.00

<i>Clarkia purpurea</i> ssp. <i>quadrivulnera</i>	clarkia	0.76
<i>Elymus glaucus</i>	blue wildrye	10.00
<i>Lotus purshianus</i>	Spanish clover	3.00
<i>Lotus scoparius</i>	deerweed	6.00
<i>Lupinus nanus</i>	sky lupine	3.00
<i>Oenothera hookeri</i>	evening primrose	2.00
<i>Vulpia microstachys</i>	three weeks fescue	4.00
TOTAL		39.76
Native Seed Mix #4 (blue quadrant)		
<i>Achillea millefolium</i>	yarrow	1.00
<i>Bromus carinatus</i>	California brome	9.00
<i>Elymus glaucus</i>	blue wildrye	8.00
<i>Eriogonum nudum</i>	naked buckwheat	0.25
<i>Eriophyllum confertiflorum</i>	golden yarrow	0.05
<i>Festuca occidentalis</i>	western fescue	6.00
<i>Leymus triticoides</i>	creeping wildrye	2.00
<i>Lotus purshianus</i>	Spanish clover	3.00
<i>Melica californica</i>	California melic	3.00
<i>Plantago erecta</i>	California plantain	3.00
<i>Poa secunda</i>	one-sided bluegrass	3.00
<i>Scrophularia californica</i>	beeplant	0.25
<i>Sisyrinchium bellum</i>	blue eyed grass	1.00
<i>Vulpia microstachys</i>	three weeks fescue	8.00
TOTAL		47.55

5.2 Test Plot Plantings

Planting of trees and shrubs in containers will occur in the test plots to mimic planned tree and shrub groupings in revegetation areas. Planting will only take place in plots with 24-inch soil treatments (plots 10-12 and 16). At least ten individuals from each species will be planted in the test plots. Shrubs are to be planted on 4.5-foot centers, and trees on 9-foot centers. Final species selection is currently in progress and installation will occur in early winter 2009-2010. Additional seed may be collected onsite in 2009 and sown in certain test plots to assess success of onsite seed collection and use.

Table 11. Mulch and hydroslurry application rates.	
TREATMENT	APPLICATION RATE (lb / acre)
Weed-free sterile wheat straw mulch	4000
“Fiber Wood” organic mulch	2000
Plantago-based M-binder (tackifier)	200
42-0-0 Sulphur-coated urea	175
0-0-50 Sulfate “potash”	175
mycorrhizal inoculant (EMSA site only)	120

6.0 MAINTENANCE

Maintenance of the revegetation areas shall consist of reseeding or replanting unsuccessful revegetation efforts, weed control to limit the extent of noxious weeds, and repair of erosion damage.

If revegetation efforts are not successful with regard to the performance standards outlined in Section 7.3 of this report within five years following initial seeding, the seeding areas will be reevaluated to determine the measures necessary to improve revegetation performance. If necessary, these areas will be reseeded and/or replanted with methods modified as needed. This may include the use of container stock and irrigation or simply reseeding during a wet winter season. Prior to reseeding, the operator shall evaluate previous revegetation practices to identify cultural methods to benefit the overall revegetation effort. If, after a site is reseeded, revegetation efforts still do not yield satisfactory results, additional reseeding or other intervention methods may be required.

If any significant rills or gullies are noticed in the RPA Area, remedial actions will include reseeding of the area with an approved erosion control seed mix, and if necessary, slope stabilization measures will be undertaken.

While weed control is necessary to reduce the occurrence of undesirable non-native species of plants that may invade the site where disturbance has removed the native plant cover and where active and natural revegetation is taking place, many non-native weedy plants are known from both the surrounding active quarry and adjacent natural open-space lands. Weeds (non-native invasive species) can compete with native plant species for available moisture and nutrients and consequently interfere with revegetation efforts. Reference plots were implemented in undisturbed natural grassland habitat to assess native and non-native species richness and cover. The reference plots contained 28 species, thirteen of which were non-native, and an additional eight are considered non-native invasives. Although the two of the seven native species had the highest cover, the next ten species with the highest cover were non-native or invasive species. Non-native and invasive species accounted for over 50% of the vegetative cover. Therefore success criteria were developed that took this information into account. That said, invasive species listed in the California Invasive Plant Council’s inventory (Cal-IPC 2006) will be considered problematic and will be targeted during maintenance of this revegetation effort if they exceed the designated threshold of thirty percent cover. Invasive plant species typically found at the Quarry and in surrounding lands include yellow star thistle (*Centaurea solstitialis*, annual), black mustard (*Brassica nigra*, annual), stinkwort (*Dittrichia graveolens*, annual), pampas grass (*Cortaderia* spp., perennial), and fennel (*Foeniculum vulgare*, perennial).

7.0 MONITORING

7.1 Installation Monitoring

To ensure that the revegetation plan is followed, all implementation activities shall be monitored by a qualified individual. Records shall be kept of soil replacement, addition of soil amendments as determined to be necessary, and hydroseeding. Hydroseeding will further be detailed to identify the date of application and the location where various seed mixes are applied. This will require the preparation of a map to show the location of the revegetation sites and date of seed application. Additionally, the installation of tree and shrub plantings will be detailed to identify the location and approximate area of those planting areas and the number of trees or shrubs planted or seeded there.

7.2 Vegetation Monitoring

Monitoring must be performed to document revegetation success. Following installation, each revegetation area will be monitored up to three times during the following five year period. Contouring and revegetation will be conducted in stages, therefore, monitoring of each stage will commence upon completion of that revegetation area, and each stage will be monitored up to three times during the following five year period after installation, or until the area meets success criteria for two consecutive years without intervention. The suggested monitoring schedule is during the first, third, and fifth years following planting to ensure establishment and final survival of plantings. Revegetation sites shall be identified on a map and monitored to assure that standards are adequately achieved to within a minimum of 80 percent confidence level. The restoration efforts will be considered complete when the success criteria have been fulfilled.

Tree and Shrub Planting Areas - Monitors will randomly select five percent of the total area of tree and shrub areas to be monitored. The site should be stratified based on each installation stage, such that five percent of the planting areas within each stage is monitored for five years following installation. In addition, both north-facing slopes and south-facing slopes should be represented in sampling. Monitors will identify and count all trees and shrubs surviving in the monitored areas. The boundary of the area to be monitored will be mapped and the total number of trees and shrubs present will be used to estimate tree and shrub density. Additionally three 20-meter transects will be randomly placed in each tree and shrub area previously selected for sampling. A monitor will walk the transect, assessing presence of cover of tree or shrub species at one-meter intervals, resulting in 20 observations per transect or 60 per tree planting bench. These data will be used to determine if the percent cover performance criteria is met.

Hydroseed areas- Monitors will randomly place no less than 24¹ square meter quadrats throughout the areas seeded with grasses, herbs, and shrubs to determine percent cover by each species. Prior to completion of all contouring stages in 2015, the number of quadrats should be based on the areas revegetated, with at least one quadrat sampled for every two acres installed. The percent cover by species will be used to evaluate if the hydroseeded areas are meeting performance standards for cover and species richness.

Sites will be monitored in late spring to ensure that most plants will be identifiable to the species level. Monitoring will be conducted by a qualified biologist with experience in plant identification. After monitoring data has been collected, a report summarizing the success of revegetation

¹ The number of quadrats to be sampled was chosen based on species accumulation curves produced from sampling various undisturbed shrub-, tree-, and grass-dominated habitats on the Quarry property.

efforts, comparison of data to Year 5 performance standards, any observed obstacles to achieving Year 5 performance standards, and any remedial actions recommended will be prepared and submitted to Lehigh Permanente Cement no later than October 15 of that year. This will allow for proper timing of remedial plantings and/or seeding if determined to be necessary.

7.3 Performance Standards

Revegetation of approximately 72 acres in the RPA Area is intended to create approximately 10 percent coverage of planted tree and shrub areas interspersed among seeded grassland and shrub areas within five years of installation. Planting areas on south-facing benches of the RPA Area would be dominated by shrubs with scattered grey pine trees while planting areas on north- and east-facing benches would be dominated by trees and shrubs. Performance standards are necessary to describe species richness, percent cover, and stem density for tree and shrub benches as well as the hydroseed areas. Performance standards represent anticipated conditions five years after installation, based on a study of reference sites in the vicinity conducted by WRA. SMARA requirements state that performance standards must be met for two consecutive years without significant human intervention prior to release of financial assurances.

Reference site data were used to create a science-based and achievable set of performance standards. Native species richness targets have been chosen to reflect data collected from the reference sites. These densities and percent cover values reflect the expected growth of trees and shrubs in the first five years of the revegetation areas.

		TREE & SHRUB AREAS (north-facing and east-facing benches)			SHRUB AREAS (south-facing benches, will include scattered grey pine)			HYDROSEED AREAS (shrub/grassland between tree areas)		
		Tree	Shrub	Herb	Tree	Shrub	Herb	Tree	Shrub	Herb
proposed EMSA standards	Richness (<i>avg. native species per acre</i>)	1	2	3	0	2	2	0	1*	3*
	Canopy Cover	20%	20%	50%	0%	40%	20%	0%	5%*	50%*
	Density (<i>stems per acre</i>)	102	408	-	0	272	-	-	-	-

*Performance criteria for hydroseed areas may need to be adjusted to reflect feasible five-year results of the species mix ultimately selected based on test plot results. In particular, the balance between cover of shrubs and herbaceous species may vary.

Reference data values for percent cover and density of trees and shrubs describe mature woody communities that have not seen significant disturbance in decades. While the target plant communities of the revegetation areas should blend with these mature communities, they cannot be expected to achieve similar characteristics over only five years of growth. Instead, shrub and tree planting areas are designed to mimic pioneering plant communities that will expand to dominate the benches and slopes over several decades through natural regeneration.

For herb species, both in the understory of tree and shrub planting areas as well as in the hydroseed areas, the species richness is proposed to more accurately reflect the composition of

herb communities in the adjacent landscape. The percent cover targets for mixed herb and shrub communities are proposed to be revised to reflect current conditions in undisturbed portions of the RPA Area and the expected coverage of seeded species after five years of growth in the revegetation areas.

7.4 Performance Standards for Weed Control

In addition to biannual vegetation monitoring to assess the success of revegetation efforts, the density of weeds (non-native invasive plants) will be assessed within the grassland quadrats described in Section 7.2. For the purposes of site maintenance and monitoring, non-native plants listed on the California Invasive Plant Council Inventory (Cal-IPC 2006) as “High” will be considered invasive weeds. If invasive weeds are found to exceed thirty percent relative cover over all sampled quadrats, weed abatement activities will commence. Weed control methods may include chemical and mechanical removal techniques depending on the species and number of individuals encountered. Priorities in weed abatement should focus on those species listed as High, in addition to species that directly threaten the successful establishment and survival of native species. The percent cover of weeds, abatement measures recommended and undertaken, and other observations on weed control will be included in vegetation monitoring reports. Weed abatement responsibilities will cease once success criteria have been met for each phase of revegetation efforts.

7.5 Adaptive Management

The operators responsible for revegetation at the Quarry have seen success with adaptive strategies. The strategy described above may prove to be less efficient than other strategies developed at a later date. Therefore, if a different planting strategy is implemented on the site in which the above performance standards and monitoring guidelines cannot be followed, a revision to this revegetation plan will be submitted as a substitute for this document or portions thereof.

8.0 REFERENCES

- Cal-IPC. 2006. California Invasive Plant Inventory. Cal-IPC Publication 2006-02. California Invasive Plant Council: Berkeley, CA. Available: www.cal-ipc.org/inventory
- California Association of Nurseries and Garden Centers (CANGC). 2008. *Phytophthora ramorum* Nursery Industry Best Management Practices Manual. September. Available at: http://www.suddenoakdeath.org/html/nursery_best_mgmt_practices.html
- California Oak Mortality Task Force (COMTF). 2008. List of *P. ramorum* regulated hosts and associated plants. May. Available at: http://www.suddenoakdeath.org/html/host_plant_lists.html
- Ruth and Going Inc. 1984. Reclamation Plan Kaiser Cement Permanente Quarry. Prepared for the County of Santa Clara, October 1984.
- Science Applications International Corporation (SAIC). 2004. Burton Mesa Mitigation Site Final Project Report, prepared for: Central Coast Water Authority. Buellton, California.
- U.S. Department of Agriculture, Soil Conservation Service. 1958. Soil Survey of Santa Clara Area, California. In cooperation with the University of California Agricultural Experiment Station.
- WRA, Inc. 2009a. Biological Resources Assessment for the Permanente Quarry East Materials Storage Area, Cupertino, Santa Clara County, California. March.
- WRA, Inc. 2009b. Soil Development Plan for the East Materials Storage Area at Permanente Quarry, Cupertino, Santa Clara County, California. March.

APPENDIX A
PHOTOGRAPHS OF TEST PLOTS
AND PREVIOUS REVEGETATION SITES



Appendix A - Revegetation and Test Plot Photographs

Top: Yeager Yard Test Plots (October 21, 2008)

Bottom: EMSA Test Plots (October 21, 2008)





Top: Test plot construction at Yeager Yard:
Blending soil materials (October 17, 2008)

Bottom: Early spring growth of hydroseed in
the EMSA test plots (February 2, 2009)





Previous successful revegetation areas supporting dense cover of native shrubs.

Top: Site at the "East Pit" (May 27, 2008).

Bottom: Site in the EMSA (February 12, 2009).



APPENDIX B

PLANT LIST FOR PERMANENTE QUARRY REVEGETATION



Appendix B. Potential native plant palette for Lehigh Permanente Quarry revegetation. Species in bold were successfully established in previous revegetation efforts, or have colonized revegetation sites effectively, and should be included in seed mixes or planting palettes.

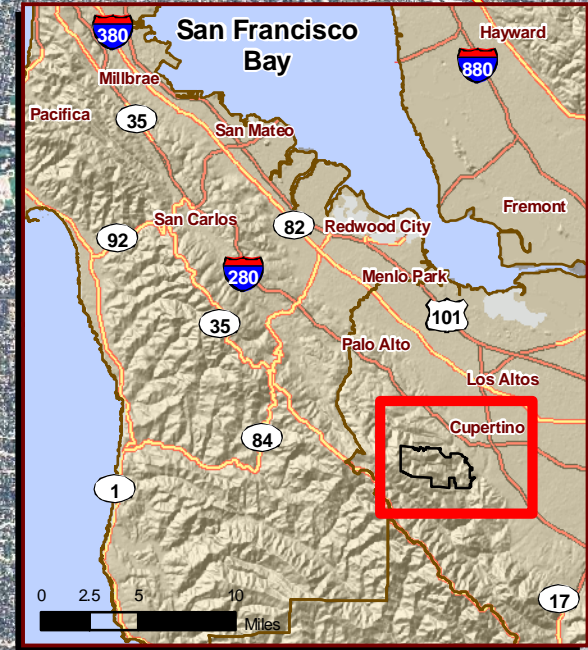
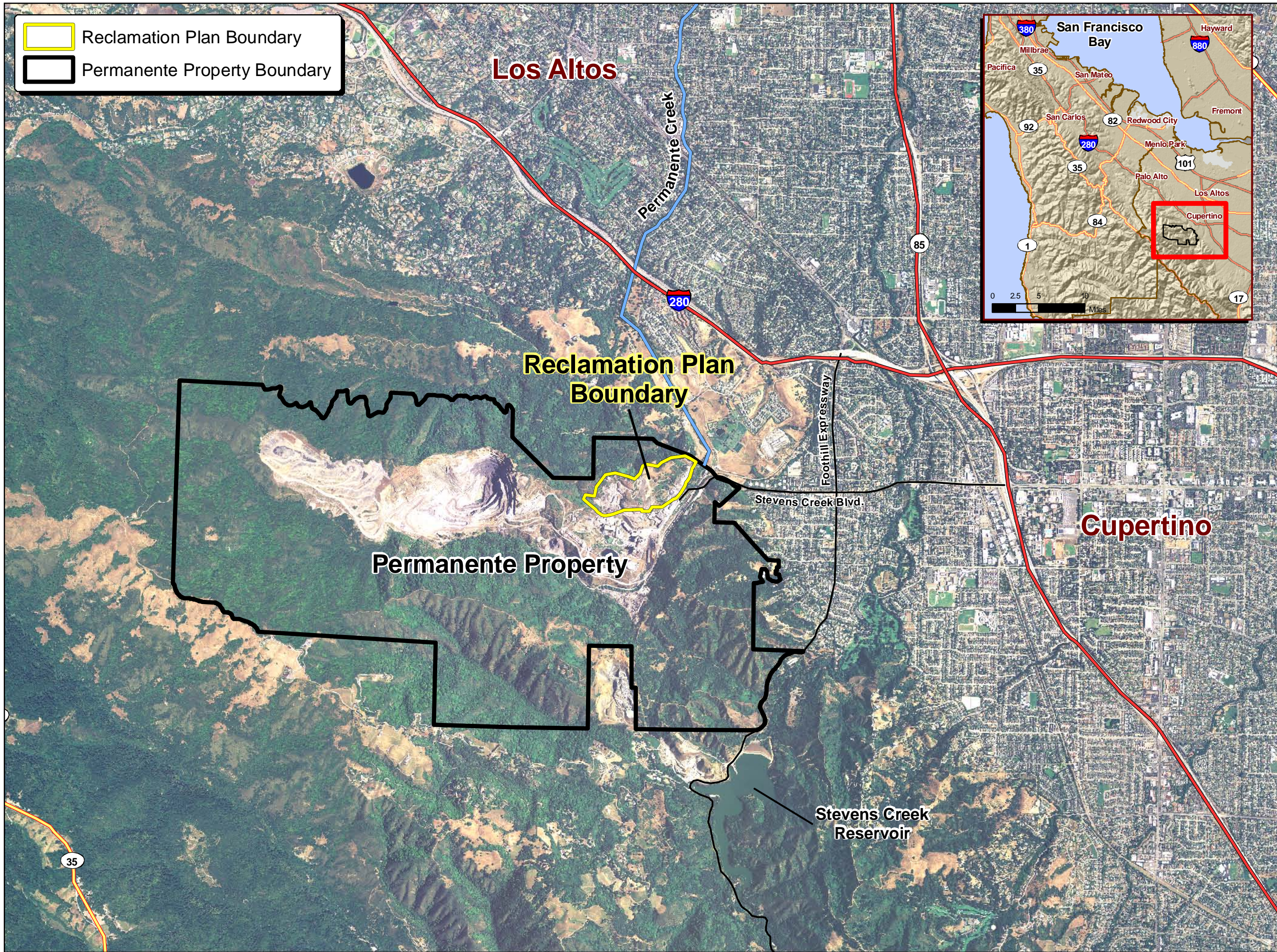
FAMILY	SCIENTIFIC NAME	COMMON NAME
NATIVE GRASSES		
Poaceae	<i>Bromus carinatus</i>	California brome
Poaceae	<i>Elymus glaucus</i>	blue wildrye
Poaceae	<i>Elymus multisetas</i>	big squirreltail grass
Poaceae	<i>Festuca occidentalis</i>	western fescue
Poaceae	<i>Festuca rubra</i>	red fescue
Poaceae	<i>Leymus triticoides</i>	creeping wild rye
Poaceae	<i>Melica californica</i>	California melic grass
Poaceae	<i>Nassella pulchra</i>	purple needle grass
Poaceae	<i>Vulpia microstachys</i>	three-weeks fescue
Poaceae	<i>Poa secunda</i>	one-sided bluegrass
NATIVE HERBS		
Asteraceae	<i>Achillea millefolium</i>	common yarrow
Asteraceae	<i>Achyrachaena mollis</i>	blow wives
Asteraceae	<i>Eriophyllum confertiflorum</i>	golden yarrow
Asteraceae	<i>Heterotheca grandiflora</i>	telegraphweed
Asteraceae	<i>Wyethia glabra</i>	smooth mule ears
Brassicaceae	<i>Streptanthus glandulosus ssp. glandulosus</i>	bristly jewelflower
Caryophyllaceae	<i>Silene californica</i>	California windmill pink
Fabaceae	<i>Lotus purshianus var. purshianus</i>	Spanish clover
Fabaceae	<i>Lotus scoparius</i>	deerweed
Fabaceae	<i>Lupinus bicolor</i>	miniature lupine
Fabaceae	<i>Lupinus microcarpus var. densiflorus</i>	chick lupine
Fabaceae	<i>Lupinus nanus</i>	sky lupine
Fabaceae	<i>Lupinus succulentus</i>	succulent lupine
Fabaceae	<i>Trifolium wildenovii</i>	tomcat clover
Hydrophyllaceae	<i>Nemophila menziesii</i>	baby blue eyes
Hydrophyllaceae	<i>Phacelia campanularia</i>	desert bells
Iridaceae	<i>Sisyrinchium bellum</i>	blue-eyed grass
Lamiaceae	<i>Salvia columbariae</i>	Chia
Liliaceae	<i>Chlorogalum pomeridianum</i>	soap plant
Linaceae	<i>Linum grandiflorum</i>	flowering flax
Nyctaginaceae	<i>Mirabilis californica</i>	California four o'clock
Onagraceae	<i>Camissonia ovata</i>	sun cup
Onagraceae	<i>Clarkia purpurea ssp. quadrivulnera</i>	winecup clarkia

FAMILY	SCIENTIFIC NAME	COMMON NAME
Onagraceae	<i>Epilobium canum</i>	California fuschia
Onagraceae	<i>Oenothera elata var hookeri</i>	evening primrose
Papaveraceae	<i>Eschscholzia californica</i>	California poppy
Papaveraceae	<i>Stylomecon heterophylla</i>	wind poppy
Plantaginaceae	<i>Plantago erecta</i>	California plantain
Polemoniaceae	<i>Navarretia squarrosa</i>	Skunkbush
Polygonaceae	<i>Eriogonum nudum</i>	naked buckwheat
Portulacaceae	<i>Calandrinia ciliata</i>	red maids
Rosaceae	<i>Fragaria vesca</i>	woodland strawberry
Scrophulariaceae	<i>Antirrhinum kelloggii</i>	Kellogg's snapdragon
Scrophulariaceae	<i>Castilleja exserta</i>	purple owl's clover
Scrophulariaceae	<i>Scrophularia californica</i>	Beeplant
NATIVE SHRUBS		
Asteraceae	<i>Artemisia californica</i>	California sagebrush
Asteraceae	<i>Artemisia douglasiana</i>	California mugwort
Asteraceae	<i>Baccharis pilularis</i>	coyote brush
Caprifoliaceae	<i>Sambucus mexicana</i>	blue elderberry
Ericaceae	<i>Arctostaphylos glauca</i>	big berry manzanita
Ericaceae	<i>Arctostaphylos viscida</i>	white-leaf manzanita
Fabaceae	<i>Lupinus albifrons var. albifrons</i>	silver bush lupine
Grossulariaceae	<i>Ribes californicum</i>	hillside gooseberry
Grossulariaceae	<i>Ribes malvaceum</i>	chaparral currant
Lamiaceae	<i>Salvia leucophylla</i>	purple sage
Lamiaceae	<i>Salvia mellifera</i>	black sage
Malvaceae	<i>Malacothamnus fasciculatus</i>	chaparral bushmallow
Malvaceae	<i>Malacothamnus fremontii</i>	fremont's bushmallow
Polygonaceae	<i>Eriogonum fasciculatum</i>	California buckwheat
Rhamnaceae	<i>Ceanothus cuneatus</i>	Buckbrush
Rhamnaceae	<i>Ceanothus integerrimus</i>	deer brush
Rhamnaceae	<i>Ceanothus leucodermis</i>	chaparral whitethorn
Rhamnaceae	<i>Rhamnus californicus</i>	Coffeeberry
Rhamnaceae	<i>Rhamnus crocea</i>	Redberry
Rosaceae	<i>Adenostoma fasciculatum</i>	chamise
Rosaceae	<i>Cercocarpus betuloides</i>	birch-leaf mountain mahogany
Rosaceae	<i>Heteromeles arbutifolia</i>	toyon
Rosaceae	<i>Holodiscus discolor</i>	ocean spray
Rosaceae	<i>Prunus ilicifolius</i>	holly-leaf cherry

FAMILY	SCIENTIFIC NAME	COMMON NAME
Rosaceae	<i>Rosa californica</i>	wild rose
Scrophulariaceae	<i>Mimulus aurantiacus</i>	bush monkey flower
Sterculiaceae	<i>Fremontodendron californica</i>	flannel-bush
NATIVE TREES		
Aceraceae	<i>Acer macrophyllum</i>	Big leaf maple
Ericaceae	<i>Arbutus menziesii</i>	Pacific madrone
Fagaceae	<i>Quercus agrifolia</i>	coast live oak
Fagaceae	<i>Quercus chrysolepis</i>	canyon live oak
Fagaceae	<i>Quercus douglasii</i>	blue oak
Fagaceae	<i>Quercus wislizenii</i>	interior live oak
Hippocastanaceae	<i>Aesculus californica</i>	California buckeye
Pinaceae	<i>Pinus sabiniana</i>	grey pine
Pinaceae	<i>Pseudotsuga menziesii</i>	Douglas-fir
Taxodiaceae	<i>Sequoia sempervirens</i>	Redwood

APPENDIX C
REVEGETATION PLAN FIGURES

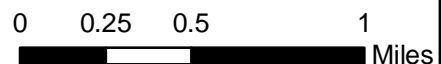
 Reclamation Plan Boundary
 Permanente Property Boundary



East Materials Storage Area,
 Lehigh Permanente Quarry,
 Santa Clara County,
 California

Figure 1.

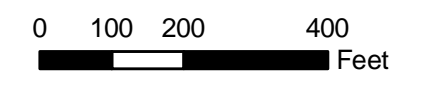
Reclamation Plan
 Amendment
 Location Map



Date: April 2009
 Map By: Michael Rochelle
 Image: 2005 NAIP
 Filepath: I:\Acad2000\16000\16143\gis\
 Arcmap\BA\EMSA\March 09\Location.mxd

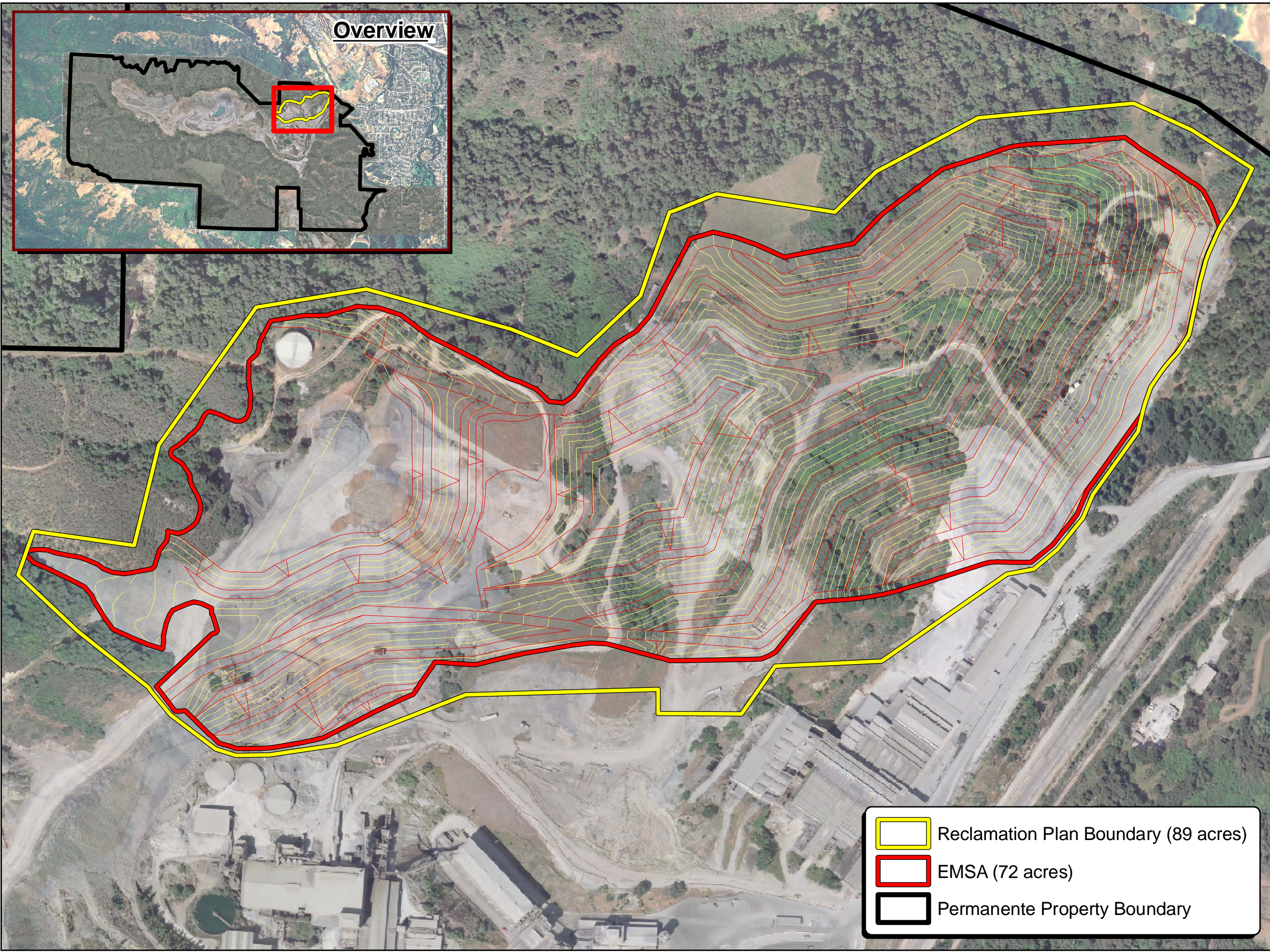
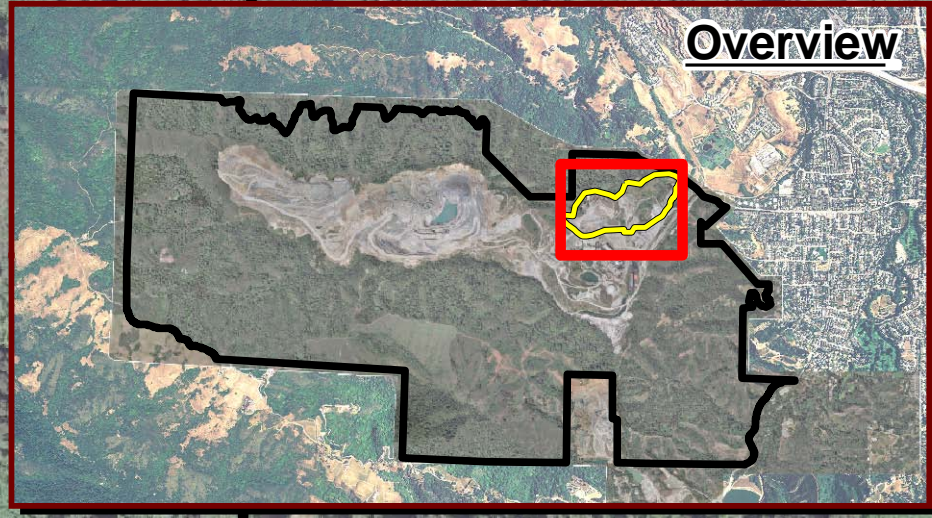
East Materials Storage Area,
Lehigh Permanente Quarry,
Santa Clara County,
California

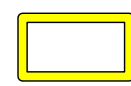
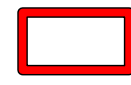

Figure 2.
Proposed Project Areas



Date: April 2009
Map By: Michael Rochelle
Image Date: April 2007
Filepath: I:\Acad2000\16000\16143\gis\Arcmap\BA\EMSA\March 09\ProjectFootprint.mxd

Overview



-  Reclamation Plan Boundary (89 acres)
-  EMSA (72 acres)
-  Permanente Property Boundary

Overview

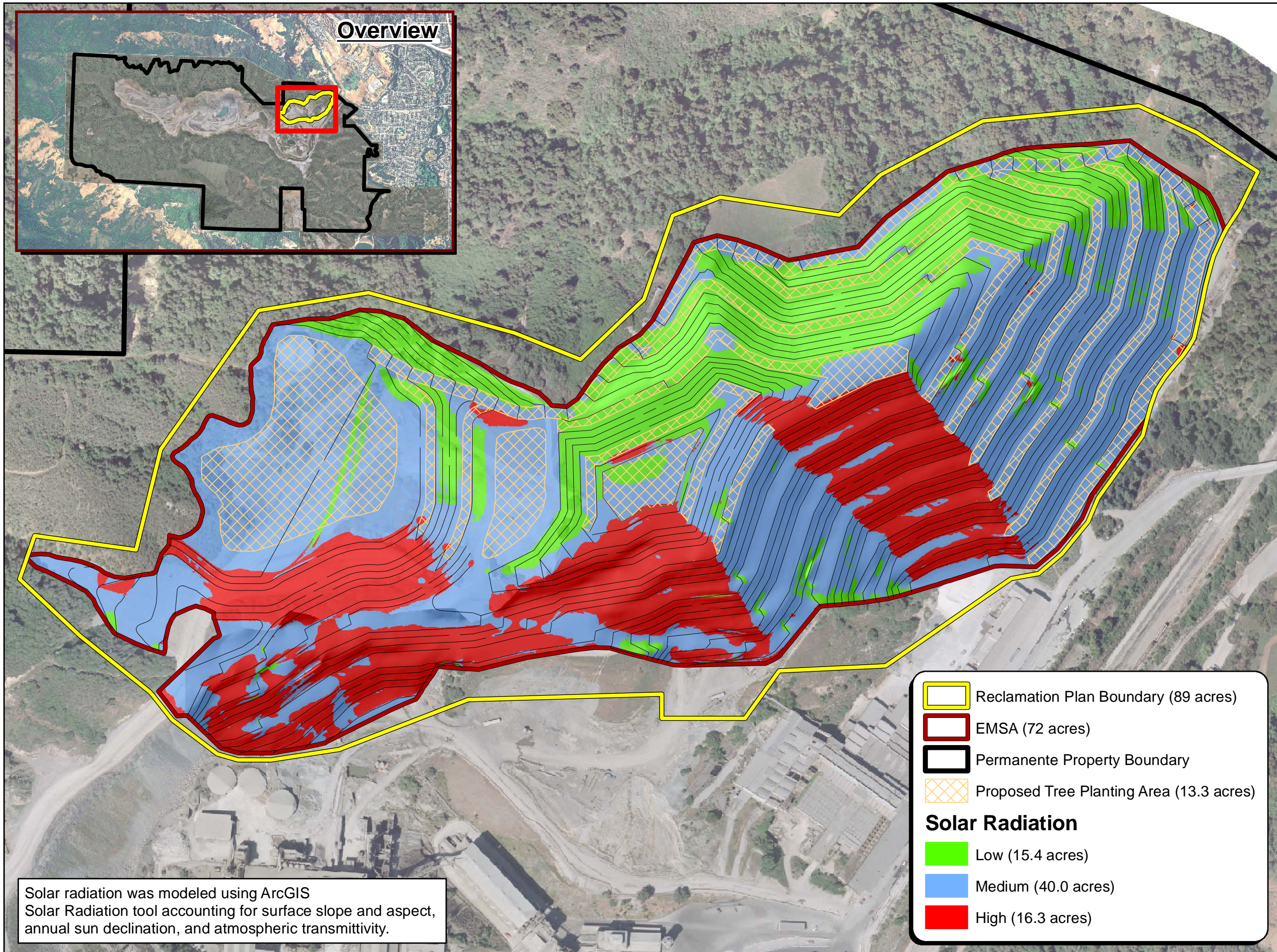
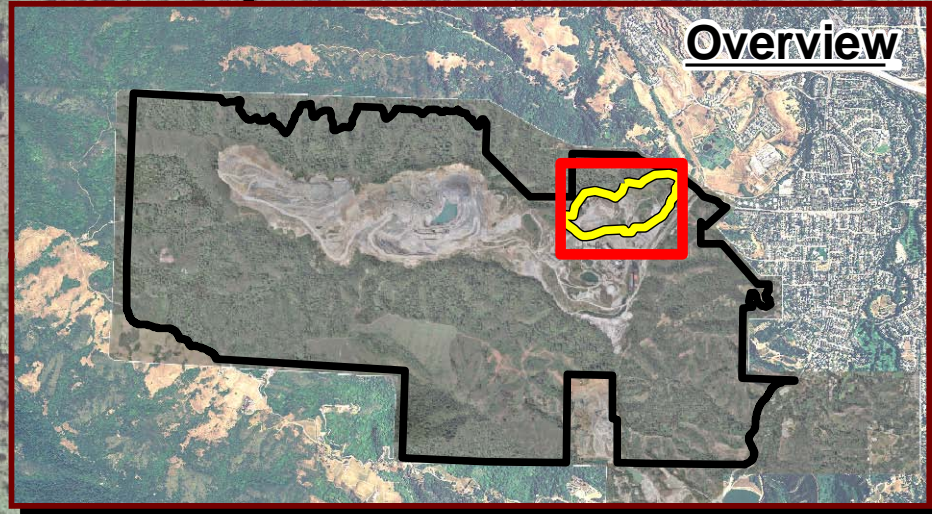
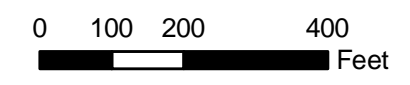


Figure 3.

Solar Radiation
within the EMSA

	Reclamation Plan Boundary (89 acres)
	EMSA (72 acres)
	Permanente Property Boundary
	Proposed Tree Planting Area (13.3 acres)
Solar Radiation	
	Low (15.4 acres)
	Medium (40.0 acres)
	High (16.3 acres)



Solar radiation was modeled using ArcGIS Solar Radiation tool accounting for surface slope and aspect, annual sun declination, and atmospheric transmittivity.

East Materials Storage Area,
Lehigh Permanente Quarry,
Santa Clara County,
California

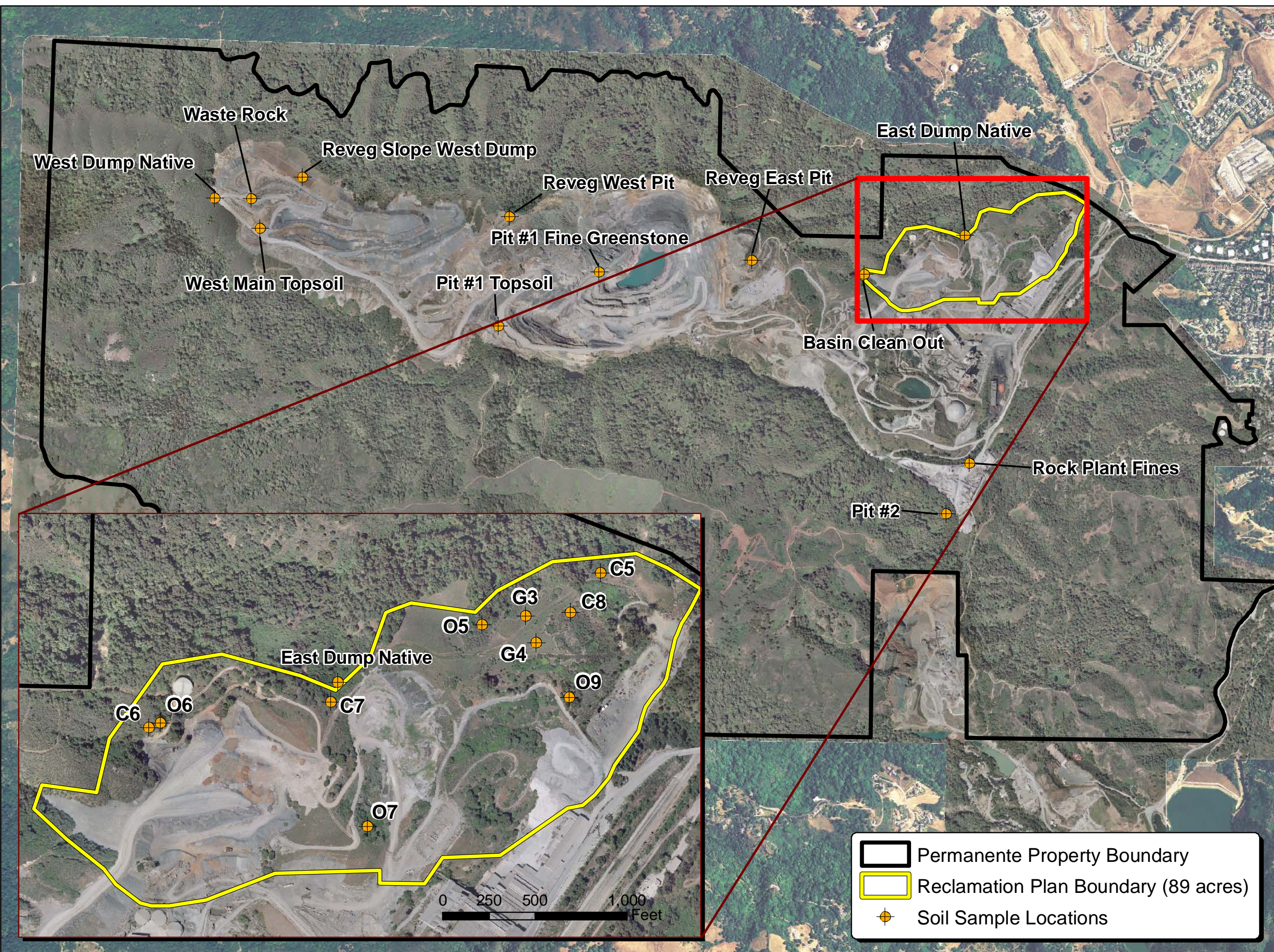



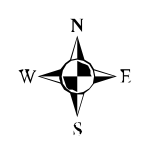


Figure 4:
Soil Sample Locations

-  Permanente Property Boundary
-  Reclamation Plan Boundary (89 acres)
-  Soil Sample Locations



0 500 1,000 2,000
Feet

Date: April 2009
Map by: Michael Rochelle
Aerial Date: April 2007
File path: I:\Acad2000\16000\16143\gis\arcmap\Soil Management Plan\Reveg Plan Revisions Late March 09\SoilSamples.mxd

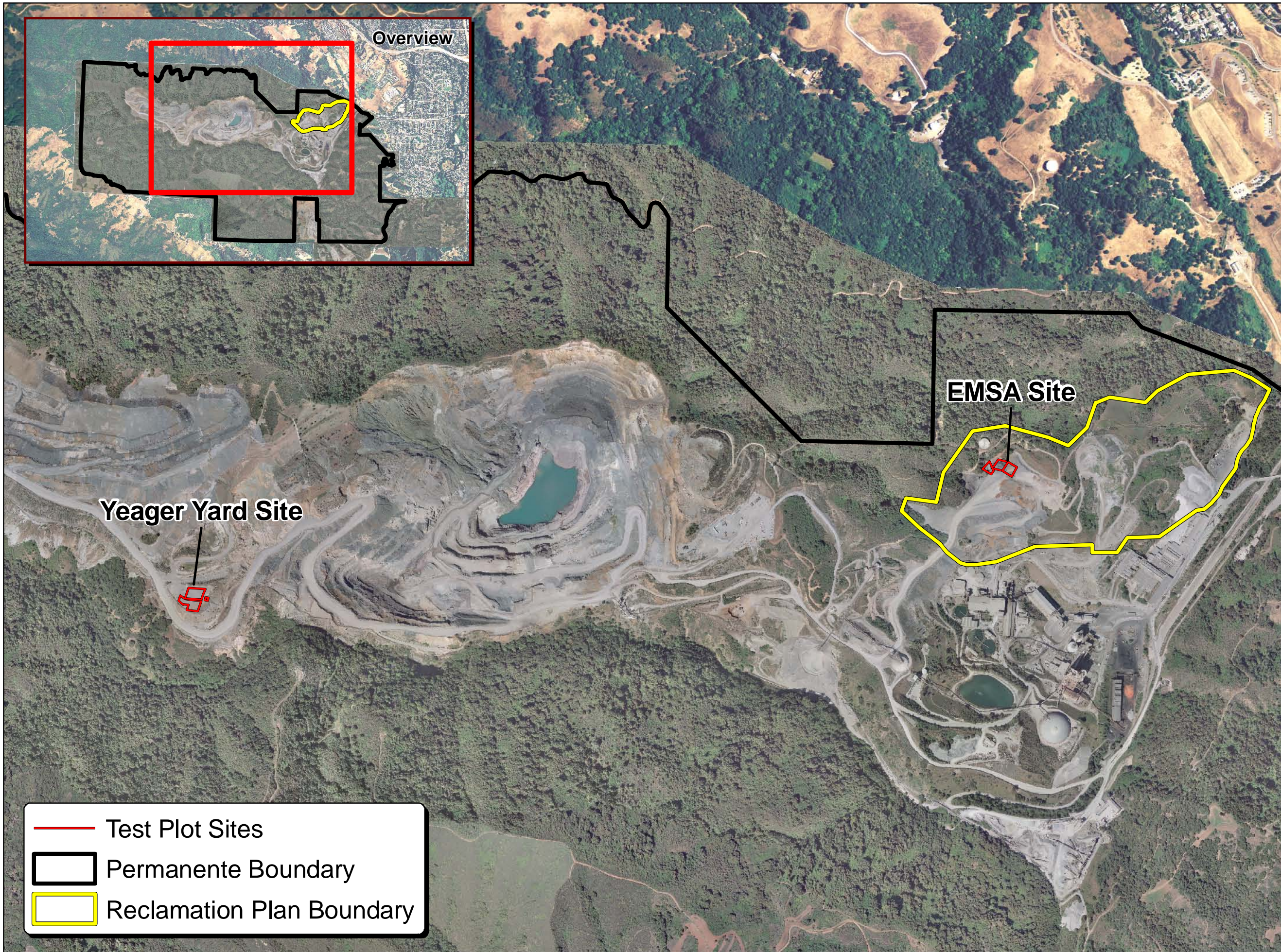
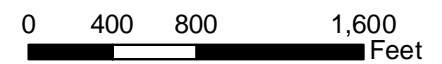


Figure 5.
Test Plot
Location Map

- Test Plot Sites
- Permanente Boundary
- Reclamation Plan Boundary



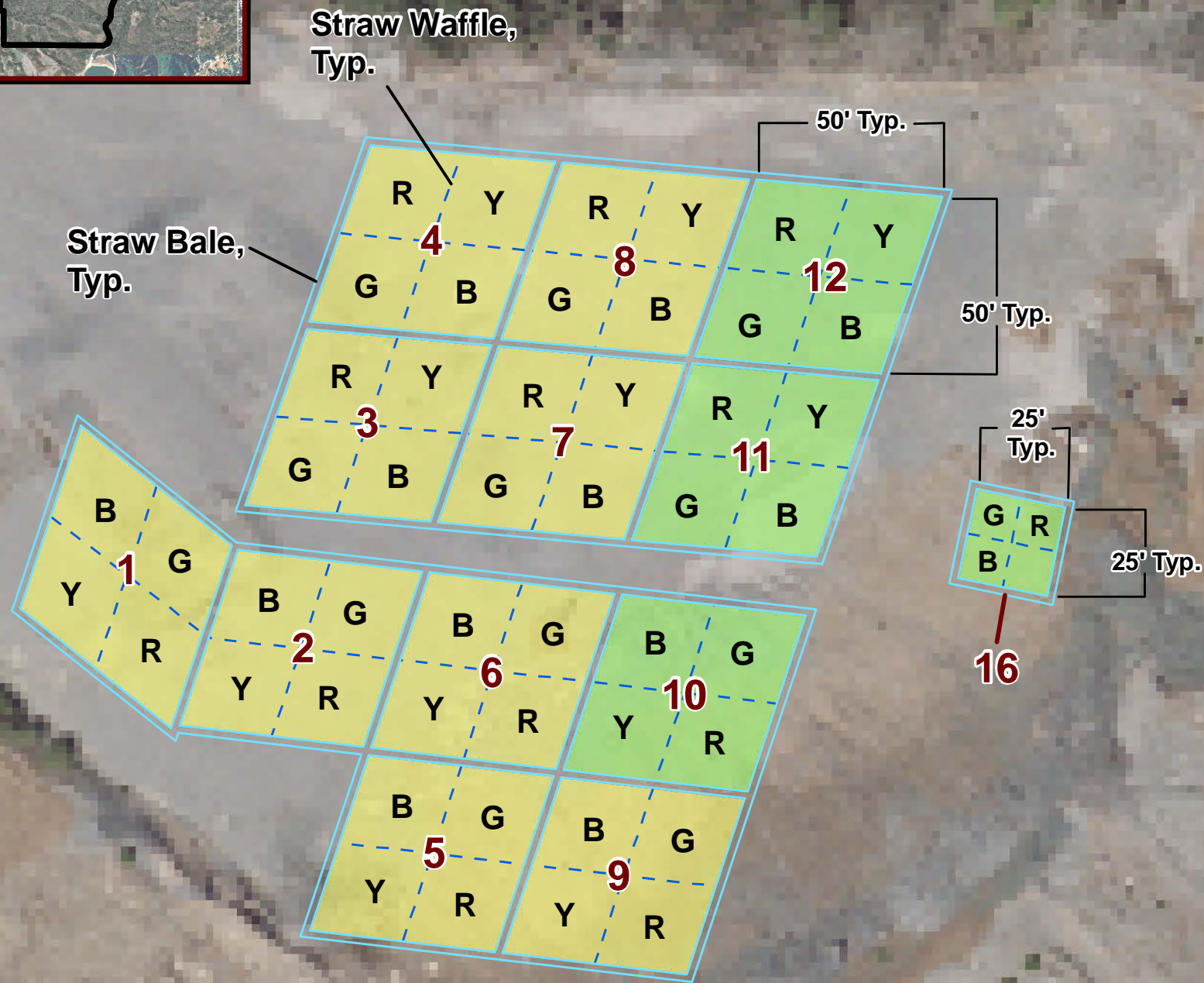
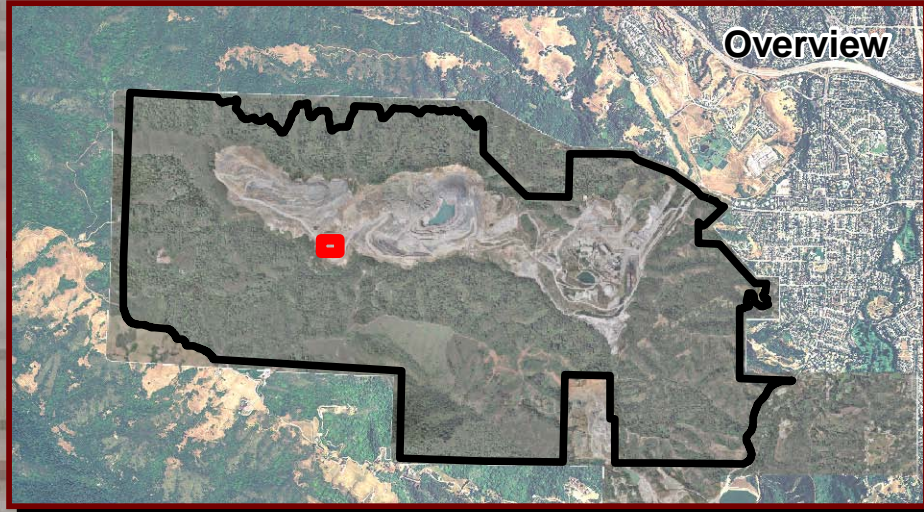
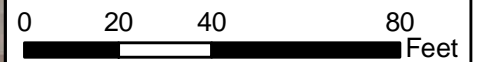


Figure 6.
Test Plot Layout
at Yeager Yard Site



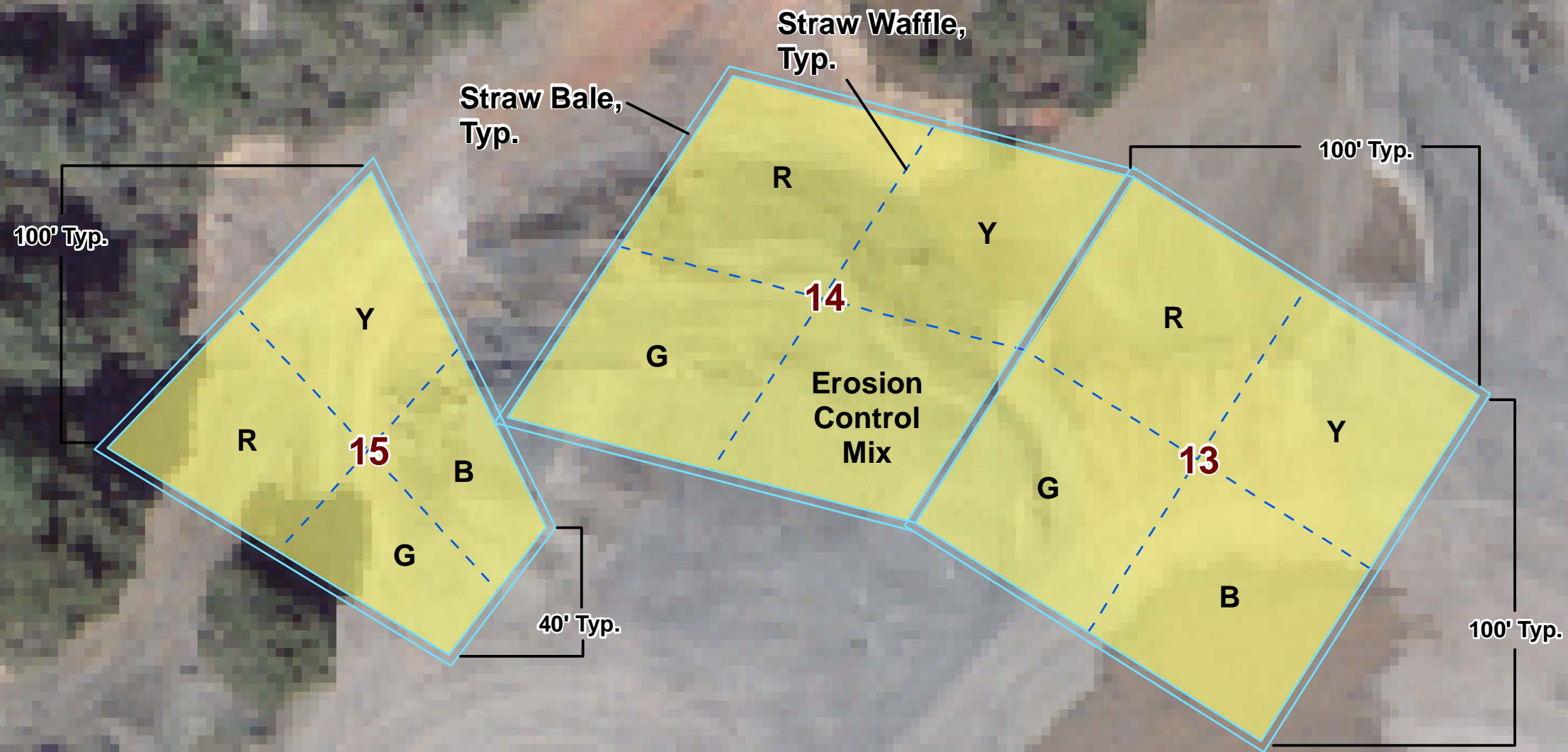
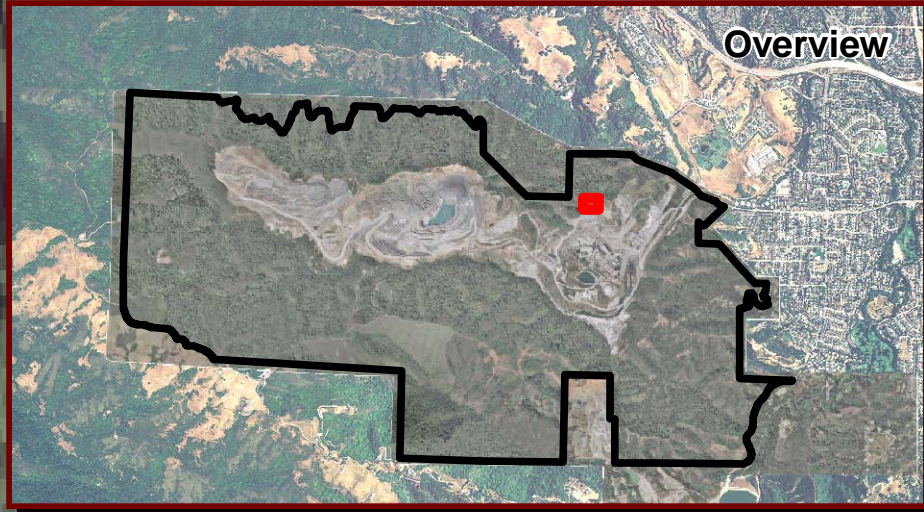
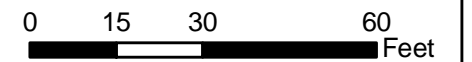


Figure 7.
Test Plot Layout
at EMSA Site



Attachment I
Master Plant List

Permanente Quarry: Observed Plant List

Family	Scientific name	Common name	Habitat				
Aceraceae	<i>Acer macrophyllum</i>	Big leaf maple	Riparian				
Aceraceae	<i>Acer negundo</i>	box elder	Riparian				
Aceraceae	<i>Acer saccharinum</i>	silver maple	Riparian				
Amaranthaceae	<i>Amaranthus albus</i>	pigweed amaranth	Riparian	Oak Woodland	Grassland	Disturbed	
Amygdalaceae	<i>Oemleria cerasiformis</i>	Indian plum	Riparian	Oak Woodland			
Anacardiaceae	<i>Toxicodendron diversilobum</i>	poison oak	Riparian	Oak Woodland		Disturbed	Oak/Bay Forest Chaparral
Anacardiaceae	<i>Rhus trilobata</i>	skunk brush		Oak Woodland			
Anacardiaceae	<i>Schinus molle</i>	Peruvian pepper tree				Disturbed	
Apiaceae	<i>Anthriscus caucalis</i>	bur chervil			Grassland	Disturbed	
Apiaceae	<i>Conium maculatum</i>	poison hemlock	Riparian		Grassland	Disturbed	
Apiaceae	<i>Foeniculum vulgare</i>	sweet fennel			Grassland	Disturbed	
Apiaceae	<i>Osmorhiza chilensis</i>	sweet cicely	Riparian	Oak Woodland			Oak/Bay Forest
Apiaceae	<i>Sanicula crassicaulis</i>	Pacific sanicle		Oak Woodland			Oak/Bay Forest
Apiaceae	<i>Scandix pecten-veneris</i>	Venus' needle			Grassland	Disturbed	
Apiaceae	<i>Torilis arvensis</i>	hedge parsley	Riparian	Oak Woodland		Disturbed	Oak/Bay Forest Chaparral
Apocynaceae	<i>Nerium oleander (Horticultural)</i>	oleander				Disturbed	
Apocynaceae	<i>Vinca major</i>	periwinkle		Oak Woodland		Disturbed	Oak/Bay Forest
Araliaceae	<i>Aralia californica</i>	bear clover	Riparian				
Araliaceae	<i>Hedera helix</i>	English ivy	Riparian				Oak/Bay Forest
Aristolochiaceae	<i>Asarum caudatum</i>	wild ginger	Riparian				Oak/Bay Forest
Asteraceae	<i>Achillea millefolium</i>	common yarrow			Grassland	Disturbed	Chaparral
Asteraceae	<i>Achyraea mollis</i>	blow wives					
Asteraceae	<i>Adenocaulon bicolor</i>	trailfinder					Oak/Bay Forest
Asteraceae	<i>Artemisia californica</i>	California sagebrush		Oak Woodland		Disturbed	Chaparral
Asteraceae	<i>Artemisia douglasiana</i>	California mugwort	Riparian	Oak Woodland			
Asteraceae	<i>Artemisia dracuncululus</i>	tarragon				Disturbed	Chaparral

Permanente Quarry: Observed Plant List

Family	Scientific name	Common name	Habitat			
Asteraceae	<i>Baccharis pilularis</i>	coyote brush	Oak Woodland	Grassland	Disturbed	Chaparral
Asteraceae	<i>Carduus pycnocephalus</i>	Italian thistle		Grassland	Disturbed	
Asteraceae	<i>Centaurea calcitrapa</i>	purple star thistle	Oak Woodland	Grassland	Disturbed	Chaparral
Asteraceae	<i>Centaurea melitensis</i>	tochalote	Oak Woodland	Grassland	Disturbed	Chaparral
Asteraceae	<i>Centaurea solstitialis</i>	yellow star thistle		Grassland	Disturbed	
Asteraceae	<i>Cichorium intybus</i>	chickory		Grassland	Disturbed	
Asteraceae	<i>Cirsium arvense</i>	canada thistle	Oak Woodland	Grassland	Disturbed	
Asteraceae	<i>Cirsium occidentale</i>	cobweb thistle	Oak Woodland	Grassland	Disturbed	
Asteraceae	<i>Cirsium sp</i>	thistle sp	Oak Woodland	Grassland	Disturbed	
Asteraceae	<i>Cirsium vulgare</i>	bull thistle	Oak Woodland	Grassland	Disturbed	
Asteraceae	<i>Conyza canadensis</i>	horseweed			Disturbed	
Asteraceae	<i>Corethrogyne filaginifolia</i>	common California aster		Grassland	Disturbed	
Asteraceae	<i>Dittrichia graveolens</i>	stinkwort		Grassland	Disturbed	
Asteraceae	<i>Eriophyllum confertiflorum</i>	golden yarrow		Grassland	Disturbed	
Asteraceae	<i>Eriophyllum lanatum</i>	woolly sunflower				Chaparral
Asteraceae	<i>Filago gallica</i>	Filago	Oak Woodland	Grassland		Chaparral
Asteraceae	<i>Gnaphalium californicum</i>	California cudweed	Oak Woodland	Grassland	Disturbed	Chaparral
Asteraceae	<i>Gnaphalium canescens ssp beneolens</i>	cudweed	Oak Woodland	Grassland	Disturbed	Chaparral
Asteraceae	<i>Gnaphalium luteo-album</i>	everlasting cudweed	Oak Woodland	Grassland	Disturbed	Chaparral
Asteraceae	<i>Grindelia camporum</i>	Great Valley gumweed	Oak Woodland	Grassland		Chaparral
Asteraceae	<i>Heterotheca grandiflora</i>	telegraphweed	Oak Woodland			Oak/Bay Forest Chaparral
Asteraceae	<i>Hieracium albiflorum</i>	white hawkweed	Oak Woodland			
Asteraceae	<i>Hypochaeris glabra</i>	smooth catsear	Oak Woodland	Grassland	Disturbed	
Asteraceae	<i>Hypochaeris radicata</i>	rough catsear	Oak Woodland	Grassland	Disturbed	

Permanente Quarry: Observed Plant List

Family	Scientific name	Common name	Habitat		
Asteraceae	<i>Lactuca serriola</i>	prickly wild lettuce	Oak Woodland	Grassland	Disturbed
Asteraceae	<i>Lactuca virosa</i>	bitter lettuce	Oak Woodland	Grassland	Disturbed
Asteraceae	<i>Lagophylla ramosissima</i> ssp. <i>ramosissima</i>	common hareleaf		Grassland	Chaparral
Asteraceae	<i>Madia elegans</i>	common madia	Oak Woodland	Grassland	Chaparral
Asteraceae	<i>Madia exigua</i>	meager tarweed			Disturbed Chaparral
Asteraceae	<i>Madia sativa</i>	coast tarweed	Oak Woodland	Grassland	Chaparral
Asteraceae	<i>Micropus</i> sp.	cottonweed		Grassland	Disturbed
Asteraceae	<i>Picris echioides</i>	bristly ox-tongue		Grassland	Disturbed
Asteraceae	<i>Senecio vulgare</i>	common groundsel	Oak Woodland		Disturbed
Asteraceae	<i>Silybum marianum</i>	milk thistle			Disturbed
Asteraceae	<i>Sonchus asper</i>	prickly sow thistle		Grassland	Disturbed Chaparral
Asteraceae	<i>Sonchus oleraceus</i>	common sow thistle		Grassland	Disturbed Chaparral
Asteraceae	<i>Stylocline gnaphaloides</i>	everlasting nest straw			Oak/Bay Forest
Asteraceae	<i>Uropappus lindleyi</i>	silver puffs	Oak Woodland		Oak/Bay Forest
Asteraceae	<i>Wyethia glabra</i>	smooth mule ears	Oak Woodland		
Asteraceae	<i>Wyethia helenioides</i>	whitehead mule ears		Grassland	
Asteraceae	<i>Wyethia</i> sp.	mule ears	Oak Woodland	Grassland	Chaparral
Asteraceae	<i>Xanthium strumarium</i>	cocklebur	Riparian		
Berberidaceae	<i>Berberis pinnata</i> ssp. <i>pinnata</i>	California barberry	Oak Woodland		
Betulaceae	<i>Alnus rhombifolia</i>	white alder	Riparian		
Blechnaceae	<i>Woodwardia fimbriata</i>	giant chain fern	Riparian		Oak/Bay Forest
Boraginaceae	<i>Amsinckia menziesii</i>	fiddle neck			Chaparral
Boraginaceae	<i>Amsinckia tessellata</i>	fiddle neck		Grassland	Disturbed
Boraginaceae	<i>Cryptantha clelandii</i>	common cryptantha		Grassland	Disturbed
Boraginaceae	<i>Cynoglossum grande</i>	hound's tongue	Oak Woodland		Oak/Bay Forest
Boraginaceae	<i>Heliotropium curassavicum</i>	heliotrpoe	Riparian		
Boraginaceae	<i>Plagiobothrys nothofulvus</i>	rusty popcornflower			Disturbed

Permanente Quarry: Observed Plant List

Family	Scientific name	Common name	Habitat			
Brassicaceae	<i>Brassica nigra</i>	black mustard	Grassland	Disturbed		
Brassicaceae	<i>Brassica rapa</i>	wild mustard	Grassland	Disturbed		
Brassicaceae	<i>Capsella bursa-pastoris</i>	shepherd's purse	Grassland	Disturbed		Chaparral
Brassicaceae	<i>Cardamine oligosperma</i>	bitter cress	Riparian			
Brassicaceae	<i>Lepidium latipes</i>	dwarf pepperweed	Riparian			
Brassicaceae	<i>Nasturtium officinale</i>	water cress	Riparian			
Brassicaceae	<i>Raphanus sativus</i>	wild radish			Disturbed	
Brassicaceae	<i>Rapistrum rugosum</i>	wild turnip*			Disturbed	
Brassicaceae	<i>Sinapis arvensis</i>	charlock mustard	Riparian		Disturbed	
Brassicaceae	<i>Streptanthus glandulosus</i> ssp. <i>glandulosus</i>	bristly jewelflower				Chaparral
Caprifoliaceae	<i>Lonicera hispidula</i> var <i>vacillans</i>	California honeysuckle	Riparian	Oak Woodland		Oak/Bay Forest
Caprifoliaceae	<i>Lonicera interrupta</i>	chaparral honeysuckle	Riparian	Oak Woodland		Oak/Bay Forest
Caprifoliaceae	<i>Sambucus mexicana</i>	blue elderberry		Oak Woodland		Oak/Bay Forest Chaparral
Caprifoliaceae	<i>Symphoricarpos albus</i>	snowberry	Riparian	Oak Woodland		Oak/Bay Forest Chaparral
Caprifoliaceae	<i>Symphoricarpos mollis</i>	creeping snowberry	Riparian	Oak Woodland		Oak/Bay Forest Chaparral
Caryophyllaceae	<i>Cerastium arvense</i>	field chickweed			Grassland	Disturbed
Caryophyllaceae	<i>Cerastium glomeratum</i>	sticky chickweed			Grassland	Disturbed
Caryophyllaceae	<i>Stellaria media</i>	common chickweed	Riparian	Oak Woodland		
Chenopodiaceae	<i>Salsola soda</i>	alkali russian thistle		Oak Woodland		Disturbed Chaparral
Convolvulaceae	<i>Calystegia</i> sp	morning glory	Riparian	Oak Woodland		Disturbed Oak/Bay Forest
Convolvulaceae	<i>Convolvulus arvensis</i>	field bindweed		Oak Woodland	Grassland	Disturbed Oak/Bay Forest Chaparral
Cornaceae	<i>Cornus nutalii</i>	dogwood		Oak Woodland		Oak/Bay Forest
Cornaceae	<i>Cornus sericea</i> ssp. <i>occidentalis</i>	western creek dogwood	Riparian			Oak/Bay Forest
Corylaceae	<i>Corylus cornuta</i> var. <i>californica</i>	California hazel	Riparian			
Crassulaceae	<i>Dudleya cymosa</i> ssp. <i>cymosa</i>	canyon live forever			Grassland (rock outcrop)	Chaparral (rock outcrop)

Permanente Quarry: Observed Plant List

Family	Scientific name	Common name	Habitat			
Crassulaceae	<i>Sedum spathulifoium</i>	Pacific stonecrop		Grassland (rock outcrop)		Chaparral (rock outcrop)
Cucurbitaceae	<i>Marah fabaceus</i>	california manroot		Oak Woodland		Oak/Bay Forest
Cupressaceae	<i>Calocedrus decurrens</i>	incense cedar				Oak/Bay Forest
Cupressaceae	<i>Cupressus sempervirens</i> (Horticultural)	Italian cypress			Disturbed	
Cyperaceae	<i>Cyperus eragrostis</i>	tall flat-sedge		Grassland	Disturbed	
Cyperaceae	<i>Eleocharis macrostachya</i>	common spikerush	Riparian		Disturbed	
Cyperaceae	<i>Schoenoplectus acutus</i>	common three square	Riparian			
Cyperaceae	<i>Schoenoplectus americanus</i>	chairmaker's bulrush	Riparian		Disturbed	
Dennstaedtiaceae	<i>Pteridium aquilinum</i>	bracken fern		Oak Woodland	Disturbed	
Dryopteridaceae	<i>Athyrium filix-femina</i> var. <i>cyclosorum</i>	lady fern	Riparian	Oak Woodland		Oak/Bay Forest
Dryopteridaceae	<i>Dryopteris arguta</i>	coast wood fern	Riparian			Oak/Bay Forest
Equisetaceae	<i>Equisetum arvense</i>	common horsetail	Riparian	Oak Woodland		
Equisetaceae	<i>Equisetum telmateia</i> ssp. <i>Braunii</i>	giant horsetail	Riparian			
Ericaceae	<i>Arbutus menziesii</i>	Pacific madrone		Oak Woodland		Oak/Bay Forest Chaparral
Ericaceae	<i>Arctostaphylos glandulosa</i>	Eastwood manzanita				Chaparral
Ericaceae	<i>Arctostaphylos glauca</i>	big berry manzanita				Chaparral
Ericaceae	<i>Arctostaphylos tomentosa</i> ssp. <i>crustacea</i>	brittleleaf manzanita				Chaparral
Ericaceae	<i>Arctostaphylos viscida</i>	white-leaf manzanita				Chaparral
Euphorbiaceae	<i>Croton setigerus</i>	turkey mullein		Oak Woodland	Grassland	Disturbed Chaparral
Fabaceae	<i>Cytisus scoparius</i>	Scotch broom				Disturbed
Fabaceae	<i>Lathyrus tingitanus</i>	Tangier pea	Riparian		Grassland	Disturbed
Fabaceae	<i>Lathyrus vestitus</i> var. <i>vestitus</i>	wild pea		Oak Woodland		
Fabaceae	<i>Lotus corniculatus</i>	birdfoot deervetch				Disturbed
Fabaceae	<i>Lotus humistratus</i>	short podded trefoil			Grassland	Disturbed
Fabaceae	<i>Lotus purshianus</i> var. <i>purshianus</i>	Spanish clover				Disturbed

Permanente Quarry: Observed Plant List

Family	Scientific name	Common name	Habitat			
Fabaceae	<i>Lotus scoparius</i>	deerweed	Oak Woodland		Disturbed	Oak/Bay Forest
Fabaceae	<i>Lotus wrangelianus</i>	Chilean trefoil		Grassland	Disturbed	
Fabaceae	<i>Lupinus albifrons</i> var. <i>albifrons</i>	silver bush lupine			Disturbed	
Fabaceae	<i>Lupinus bicolor</i>	miniature lupine		Grassland	Disturbed	
Fabaceae	<i>Lupinus microcarpus</i> var. <i>densiflorus</i>	chick lupine		Grassland	Disturbed	
Fabaceae	<i>Lupinus nanus</i>	sky lupine		Grassland	Disturbed	
Fabaceae	<i>Lupinus succulentus</i>	succulent lupine			Disturbed	
Fabaceae	<i>Medicago polymorpha</i>	bur clover	Oak Woodland	Grassland	Disturbed	Chaparral
Fabaceae	<i>Medicago sativa</i>	alfalfa			Disturbed	
Fabaceae	<i>Melilotus indicus</i>	annual yellow sweetclover	Oak Woodland	Grassland	Disturbed	Chaparral
Fabaceae	<i>Pickeringia montana</i>	Chaparral pea				Chaparral
Fabaceae	<i>Rupertia physodes</i>	California tea	Oak Woodland			
Fabaceae	<i>Trifolium dubium</i>	shamrock	Oak Woodland	Grassland		Oak/Bay Forest
Fabaceae	<i>Trifolium hirtum</i>	rose clover		Grassland		
Fabaceae	<i>Trifolium incarnatum</i>	crimson clover			Disturbed	
Fabaceae	<i>Trifolium wildenovii</i>	tomcat clover	Oak Woodland	Grassland		Oak/Bay Forest
Fabaceae	<i>Vicia cracca</i>	bird vetch	Oak Woodland	Grassland	Disturbed	
Fabaceae	<i>Vicia sativa</i>	spring vetch	Oak Woodland	Grassland	Disturbed	
Fabaceae	<i>Vicia sativa</i> ssp. <i>sativa</i>	pubescent common vetch	Oak Woodland	Grassland	Disturbed	
Fabaceae	<i>Vicia villosa</i>	hairy vetch	Oak Woodland	Grassland	Disturbed	
Fagaceae	<i>Lithocarpus densiflorus</i>	tanoak				Oak/Bay Forest
Fagaceae	<i>Quercus agrifolia</i>	coast live oak	Oak Woodland			Oak/Bay Forest
Fagaceae	<i>Quercus berberidifolia</i>	scrub oak	Oak Woodland			Chaparral
Fagaceae	<i>Quercus chrysolepis</i>	canyon live oak	Oak Woodland			

Permanente Quarry: Observed Plant List

Family	Scientific name	Common name	Habitat			
Fagaceae	<i>Quercus douglasii</i>	blue oak	Oak Woodland			
Fagaceae	<i>Quercus durata</i>	leather oak	Oak Woodland			Chaparral
Fagaceae	<i>Quercus wislizenii</i>	interior live oak	Oak Woodland			Chaparral
Garryaceae	<i>Garrya elliptica</i>	coast silk tassel	Oak Woodland			Oak/Bay Forest
Gentianaceae	<i>Centaurium muehlenbergii</i>	Muehlenbeg's centaury	Grassland	Disturbed		
Geraniaceae	<i>Erodium botrys</i>	broadleaf filaree	Oak Woodland	Grassland	Disturbed	Chaparral
Geraniaceae	<i>Erodium cicutarium</i>	redstem filaree	Oak Woodland	Grassland	Disturbed	Chaparral
Geraniaceae	<i>Geranium dissectum</i>	cutleaf geranium	Oak Woodland	Grassland	Disturbed	Chaparral
Geraniaceae	<i>Geranium molle</i>	dovefoot geranium		Disturbed		
Grossulariaceae	<i>Ribes californicum</i>	hillside gooseberry	Riparian			Oak/Bay Forest Chaparral
Grossulariaceae	<i>Ribes malvaceum</i>	chaparral currant	Riparian			Oak/Bay Forest
Grossulariaceae	<i>Ribes sanguineum</i>	flowering red currant	Riparian	Oak Woodland		Oak/Bay Forest
Hippocastanaceae	<i>Aesculus californica</i>	California buckeye	Riparian	Oak Woodland		Oak/Bay Forest
Hydrophyllaceae	<i>Eriodictyon californicum</i>	yerba santa	Oak Woodland			Chaparral
Hydrophyllaceae	<i>Nemophila heterophylla</i>	canyon nemophila				Oak/Bay Forest
Hydrophyllaceae	<i>Nemophila menziesii</i>	baby blue eyes	Oak Woodland	Grassland	Disturbed	Chaparral
Hydrophyllaceae	<i>Nemophila parviflora</i>	smallflower nemophila				Oak/Bay Forest
Hydrophyllaceae	<i>Phacelia sp</i>	phacelia	Oak Woodland	Grassland	Disturbed	Chaparral
Hypericaceae	<i>Hypericum canariense</i>	Canary Island St. John's Wort			Disturbed	
Iridaceae	<i>Iris douglasiana</i>	Douglas' iris	Oak Woodland			Oak/Bay Forest Chaparral
Iridaceae	<i>Iris fernaldii</i>	Fernald's iris	Oak Woodland			Oak/Bay Forest Chaparral

Permanente Quarry: Observed Plant List

Family	Scientific name	Common name	Habitat			
Iridaceae	<i>Sisyrinchium bellum</i>	blue-eyed grass	Oak Woodland	Grassland	Disturbed	Chaparral
Juglandaceae	<i>Juglans californica</i> var <i>hindsii</i>	walnut	Riparian	Oak Woodland		Oak/Bay Forest
Juncaceae	<i>Juncus effusus</i>	common rush	Riparian		Disturbed	
Juncaceae	<i>Juncus xiphioides</i>	irisleaf rush	Riparian	Oak Woodland		Oak/Bay Forest
Juncaceae	<i>Luzula comosa</i>	woodland rush		Oak Woodland		
Lamiaceae	<i>Clinopodium</i> = <i>Satureja douglasii</i>	yerba buena		Oak Woodland	Grassland	Disturbed
Lamiaceae	<i>Lepechinia calycina</i>	white pitcher sage		Oak Woodland		Disturbed
Lamiaceae	<i>Monardella villosa</i> ssp. <i>villosa</i>	coyote mint			Grassland	Disturbed
Lamiaceae	<i>Nepeta cataria</i>	catnip			Grassland	Disturbed
Lamiaceae	<i>Pogogyne seraphylloides</i>	thyme leaf mesamint				Disturbed
Lamiaceae	<i>Salvia columbariae</i>	chia				Chaparral
Lamiaceae	<i>Salvia leucophylla</i>	purple sage				Disturbed
Lamiaceae	<i>Salvia mellifera</i>	black sage		Oak Woodland		Chaparral
Lamiaceae	<i>Satureja douglasii</i>	yerba buena	Riparian	Oak Woodland	Grassland	Oak/Bay Forest
Lamiaceae	<i>Scutellaria tuberosa</i>	blue skullcap				Oak/Bay Forest
Lamiaceae	<i>Stachys albens</i>	cobwebby hedge nettle	Riparian			
Lamiaceae	<i>Stachys bullata</i>	California hedgenettle	Riparian	Oak Woodland	Grassland	Disturbed
Lamiaceae	<i>Stachys pycnantha</i>	short spike hedge nettle	Riparian	Oak Woodland	Grassland	
Lauraceae	<i>Umbellularia californica</i>	California bay		Oak Woodland		Oak/Bay Forest
Lemnaceae	<i>Lemna</i> sp	pondweed	Riparian			
Liliaceae	<i>Calochortus superbus</i>	superb mariposa lily			Grassland	Chaparral
Liliaceae	<i>Brodiaea elegans</i>	harvest brodiaea			Grassland	
Liliaceae	<i>Calochortus albus</i>	white fairy lantern		Oak Woodland		Disturbed
Liliaceae	<i>Calochortus luteus</i>	yellow mariposa lily			Grassland	Disturbed
Liliaceae	<i>Calochortus venustus</i>	butterfly Mariposa lily				Disturbed

Permanente Quarry: Observed Plant List

Family	Scientific name	Common name	Habitat			
Onagraceae	<i>Clarkia unguiculata</i>	woodland clarkia			Disturbed	
Onagraceae	<i>Epilobium brachycarpum</i>	annual fireweed	Oak Woodland		Disturbed	Chaparral
Onagraceae	<i>Epilobium canum</i>	California fuschia	Oak Woodland			Oak/Bay Forest
Onagraceae	<i>Epilobium ciliatum</i> var. <i>ciliatum</i>	fringed willowherb	Oak Woodland			Oak/Bay Forest Chaparral
Orchidaceae	<i>Corallorhiza striata</i>	striped coralroot	Oak Woodland			Oak/Bay Forest
Orchidaceae	<i>Epipactis helleborine</i>	helleborine				Oak/Bay Forest
Orchidaceae	<i>Piperia elegans</i>	elegant rein orchid	Oak Woodland			Oak/Bay Forest
Orobanchaceae	<i>Orobanche bulbosa</i>	chaparral broomrape				Chaparral
Orobanchaceae	<i>Orobanche fasciculata</i>	clustered broomrape				Chaparral
Papaveraceae	<i>Eschscholzia californica</i>	California poppy	Oak Woodland	Grassland	Disturbed	Chaparral
Papaveraceae	<i>Stylomecon heterophylla</i>	wind poppy	Oak Woodland		Disturbed	Chaparral
Pinaceae	<i>Cedrus deodara</i>	Deodar cedar			Disturbed	
Pinaceae	<i>Pinus contorta</i>	lodgepole pine			Disturbed	
Pinaceae	<i>Pinus pinea</i>	Italian stone pine			Disturbed	
Pinaceae	<i>Pinus sabiniana</i>	grey pine			Disturbed	
Pinaceae	<i>Pinus sp.</i>	pine sp			Disturbed	
Pinaceae	<i>Pseudotsuga menziesii</i>	Douglas-fir				Oak/Bay Forest
Plantaginaceae	<i>Plantago erecta</i>	California plantain		Grassland	Disturbed	
Plantaginaceae	<i>Plantago lanceolata</i>	English plantain		Grassland	Disturbed	
Plantaginaceae	<i>Plantago major</i>	common plantain		Grassland	Disturbed	
Poaceae	<i>Aira caryophyllea</i>	silver hairgrass		Grassland	Disturbed	
Poaceae	<i>Avena barbata</i>	slender wild oats	Oak Woodland	Grassland	Disturbed	Chaparral
Poaceae	<i>Avena fatua</i>	common wild oats	Oak Woodland	Grassland	Disturbed	Chaparral
Poaceae	<i>Brachypodium distachyon</i>	false brome	Oak Woodland	Grassland	Disturbed	
Poaceae	<i>Briza minor</i>	little quaking grass		Grassland	Disturbed	
Poaceae	<i>Bromus carinatus</i>	California brome	Oak Woodland	Grassland	Disturbed	Chaparral
Poaceae	<i>Bromus catharticus</i>	rescue grass		Grassland	Disturbed	

Permanente Quarry: Observed Plant List

Family	Scientific name	Common name	Habitat			
Poaceae	<i>Bromus diandrus</i>	ripgut brome	Oak Woodland	Grassland	Disturbed	Chaparral
Poaceae	<i>Bromus hordeaceus</i>	soft chess	Oak Woodland	Grassland	Disturbed	Chaparral
Poaceae	<i>Bromus japonicus</i>	Japanese brome	Oak Woodland	Grassland		
Poaceae	<i>Bromus madritensis ssp. rubens</i>	foxtail brome	Oak Woodland	Grassland	Disturbed	Chaparral
Poaceae	<i>Bromus sterilis</i>	poverty brome	Oak Woodland	Grassland	Disturbed	Chaparral
Poaceae	<i>Bromus vulgaris</i>	Columbia brome		Grassland	Disturbed	Chaparral
Poaceae	<i>Cortaderia selloana</i>	pampas grass			Disturbed	
Poaceae	<i>Cynodon dactylon</i>	bermuda grass			Disturbed	
Poaceae	<i>Cynosurus echinatus</i>	hedgehog dogtail grass		Grassland	Disturbed	
Poaceae	<i>Dactylis glomerata</i>	orchard grass		Grassland	Disturbed	
Poaceae	<i>Elymus glaucus</i>	blue wildrye	Oak Woodland	Grassland		
Poaceae	<i>Elymus multisetas</i>	big squirreltail grass	Oak Woodland	Grassland		
Poaceae	<i>Festuca arundinacea</i>	tall fescue	Riparian	Oak Woodland		
Poaceae	<i>Festuca occidentalis</i>	western fescue	Oak Woodland	Grassland		Chaparral
Poaceae	<i>Festuca rubra</i>	red fescue	Oak Woodland	Grassland		Chaparral
Poaceae	<i>Gastidium ventricosum</i>	nit grass		Grassland	Disturbed	
Poaceae	<i>Hordeum marinum ssp gussoneanum</i>	Mediterranean barley	Oak Woodland	Grassland	Disturbed	Oak/Bay Forest Chaparral
Poaceae	<i>Hordeum murinum ssp. leporinum</i>	foxtail barley	Oak Woodland	Grassland	Disturbed	Oak/Bay Forest Chaparral
Poaceae	<i>Leymus triticoides</i>	creeping wild rye	Oak Woodland	Grassland	Disturbed	Chaparral
Poaceae	<i>Lolium multiflorum</i>	Italian ryegrass	Oak Woodland	Grassland	Disturbed	Oak/Bay Forest Chaparral
Poaceae	<i>Melica californica</i>	California melic grass	Oak Woodland	Grassland		Chaparral
Poaceae	<i>Melica imperfecta</i>	small flowered melica	Oak Woodland	Grassland		Chaparral
Poaceae	<i>Nassella lepida</i>	small flowered needlegrass	Oak Woodland	Grassland		Chaparral

Permanente Quarry: Observed Plant List

Family	Scientific name	Common name	Habitat			
Poaceae	<i>Nassella pulchra</i>	purple needle grass	Oak Woodland	Grassland		Chaparral
Poaceae	<i>Panicum capillare</i>	witchgrass	Oak Woodland	Grassland	Disturbed	
Poaceae	<i>Arrhenatherum eliatum</i>	tall oatgrass			Disturbed	
Poaceae	<i>Phalaris aquatica</i>	Harding grass		Grassland	Disturbed	
Poaceae	<i>Phalaris californica</i>	California canarygrass	Riparian			
Poaceae	<i>Piptatherum miliaceum</i>	smilgrass	Riparian	Grassland	Disturbed	
Poaceae	<i>Poa annua</i>	annual bluegrass		Grassland	Disturbed	
Poaceae	<i>Polypogon monspeliensis</i>	rabbitsfoot grass	Riparian			Oak/Bay Forest
Poaceae	<i>Taeniantherum caput-medusae</i>	Medusa-head grass		Grassland	Disturbed	
Poaceae	<i>Vulpia microstachys</i>	three-weeks fescue		Grassland	Disturbed	
Poaceae	<i>Vulpia myuros</i>	rattail fescue		Grassland	Disturbed	
Polemoniaceae	<i>Eriastrum abramsii</i>	Abram's woollystar			Disturbed	Chaparral
Polemoniaceae	<i>Navarretia heterodoxa</i>	Calistoga pincushion plant	Oak Woodland			Chaparral
Polemoniaceae	<i>Navarretia sp</i>	pincushion plant		Grassland	Disturbed	Chaparral
Polemoniaceae	<i>Navarretia squarrosa</i>	skunkbush		Grassland	Disturbed	
Polygonaceae	<i>Eriogonum fasciculatum</i>	california buckwheat	Oak Woodland	Grassland	Disturbed	Chaparral
Polygonaceae	<i>Eriogonum giganteum var. giganteum</i> (planted?)	St. Catherine's lace				Chaparral
Polygonaceae	<i>Eriogonum nudum</i>	naked buckwheat		Grassland	Disturbed	
Polygonaceae	<i>Polygonum arenastrum</i>	common knotweed	Riparian	Grassland		
Polygonaceae	<i>Polygonum sp</i>	knotweed sp	Riparian	Grassland		
Polygonaceae	<i>Rumex conglomeratus</i>	clustered dock	Riparian	Grassland	Disturbed	
Polygonaceae	<i>Rumex crispus</i>	curly dock	Riparian	Grassland	Disturbed	
Polygonaceae	<i>Rumex pulcher</i>	fiddle dock	Riparian	Grassland	Disturbed	
Polypodiaceae	<i>Polypodium californicum</i>	California polypody	Riparian			Oak/Bay Forest
Portulacaceae	<i>Calandrinia ciliata</i>	red maids		Grassland	Disturbed	
Portulacaceae	<i>Claytonia parviflora</i>	miner's lettuce	Riparian	Oak Woodland		Oak/Bay Forest Chaparral
Portulacaceae	<i>Claytonia perfoliata</i>	miner's lettuce	Riparian	Oak Woodland		Oak/Bay Forest
Portulacaceae	<i>Claytonia siberica</i>	candyflower	Riparian	Oak Woodland		Oak/Bay Forest
Primulaceae	<i>Anagallis arvensis</i>	scarlet pimpernell		Grassland	Disturbed	

Permanente Quarry: Observed Plant List

Family	Scientific name	Common name	Habitat		
Primulaceae	<i>Trientalis latifolia</i>	star-flower	Riparian		Oak/Bay Forest
Pteridaceae	<i>Adiantum aleuticum</i>	five-finger fern	Riparian	Oak Woodland	Oak/Bay Forest
Pteridaceae	<i>Adiantum jordanii</i>	California maiden-hair fern	Riparian	Oak Woodland	Oak/Bay Forest
Pteridaceae	<i>Pellaea andromedifolia</i>	coffee fern	Riparian	Oak Woodland	Oak/Bay Forest
Pteridaceae	<i>Pentagramma triangularis</i>	gold back fern			Oak/Bay Forest
Ranunculaceae	<i>Actaea rubra</i>	baneberry	Riparian		Oak/Bay Forest
Ranunculaceae	<i>Aquilegia formosa</i>	western columbine			Oak/Bay Forest
Ranunculaceae	<i>Clematis lasiantha</i>	chaparral clematis	Riparian	Oak Woodland	Oak/Bay Forest
Ranunculaceae	<i>Delphinium californicum</i> ssp. <i>interius</i>	coast larkspur	Riparian	Oak Woodland	Oak/Bay Forest Chaparral
Ranunculaceae	<i>Delphinium nudicale</i>	red larkspur			Oak/Bay Forest
Ranunculaceae	<i>Ranunculus californicus</i>	common buttercup		Oak Woodland	Oak/Bay Forest Chaparral
Ranunculaceae	<i>Ranunculus canus</i>	Great Valley buttercup		Oak Woodland	Oak/Bay Forest Chaparral
Ranunculaceae	<i>Thalictrum fendleri</i> var <i>fendleri</i>	Fendler's meadow rue	Riparian	Oak Woodland	Oak/Bay Forest
Rhamnaceae	<i>Ceanothus cuneatus</i>	buckbrush		Oak Woodland Grassland	Chaparral
Rhamnaceae	<i>Ceanothus integerrimus</i>	deer brush		Oak Woodland Grassland	Chaparral
Rhamnaceae	<i>Ceanothus leucodermis</i>	chaparral whitethorn		Oak Woodland Grassland	Chaparral
Rhamnaceae	<i>Ceanothus oliganthus</i>	hairy ceanothus		Oak Woodland Grassland	Chaparral
Rhamnaceae	<i>Rhamnus californicus</i>	coffeeberry		Oak Woodland	Oak/Bay Forest Chaparral
Rhamnaceae	<i>Rhamnus crocea</i>	redberry		Oak Woodland	Chaparral
Rhamnaceae	<i>Rhamnus tomentella</i>	hoary coffeeberry		Oak Woodland	Chaparral
Rosaceae	<i>Adenostema fasciculatum</i>	chamise			Chaparral

Permanente Quarry: Observed Plant List

Family	Scientific name	Common name	Habitat			
Rosaceae	<i>Cercocarpus betuloides</i>	birch-leaf mountain mahogany	Oak Woodland			Oak/Bay Forest Chaparral
Rosaceae	<i>Fragaria vesca</i>	woodland strawberry	Oak Woodland	Disturbed		Oak/Bay Forest
Rosaceae	<i>Heteromeles arbutifolia</i>	toyon	Oak Woodland			Oak/Bay Forest Chaparral
Rosaceae	<i>Holodiscus discolor</i>	Ocean spray	Oak Woodland			Chaparral
Rosaceae	<i>Physocarpus capitatus</i>	Pacific ninebark	Riparian			
Rosaceae	<i>Prunus emarginata</i>	bitter cherry				
Rosaceae	<i>Prunus ilicifolius</i>	holly-leaf cherry	Oak Woodland			Chaparral
Rosaceae	<i>Rosa californica</i>	wild rose	Riparian	Oak Woodland		Oak/Bay Forest
Rosaceae	<i>Rubus discolor</i>	western raspberry	Riparian	Oak Woodland		Oak/Bay Forest
Rosaceae	<i>Rubus parviflorus</i>	western thimbleberry	Riparian	Oak Woodland		Oak/Bay Forest
Rosaceae	<i>Rubus ursinus</i>	California blackberry	Riparian	Oak Woodland		Oak/Bay Forest
Rosaceae	<i>Sanguisorba minor</i> ssp. <i>muricata</i>	small burnet		Grassland	Disturbed	Chaparral
Rubiaceae	<i>Galium aparine</i>	common bedstraw	Riparian	Oak Woodland		Oak/Bay Forest Chaparral
Rubiaceae	<i>Galium porrigens</i>	climbing bedstraw		Oak Woodland		Oak/Bay Forest Chaparral
Rubiaceae	<i>Galium tricornutum</i>	rough bedstraw	Riparian	Oak Woodland		Oak/Bay Forest Chaparral
Salicaceae	<i>Populus balsamifera</i> ssp. <i>trichocarpa</i>	black cottonwood	Riparian			
Salicaceae	<i>Populus fremontii</i>	Fremont's cottonwood	Riparian			
Salicaceae	<i>Populus trichocarpa</i>	black cottonwood	Riparian			
Salicaceae	<i>Salix babylonica</i>	weeping willow	Riparian			
Salicaceae	<i>Salix gooddingii</i>	Gooding's black willow	Riparian			
Salicaceae	<i>Salix laevigata</i>	red willow	Riparian			Chaparral
Salicaceae	<i>Salix lasiolepis</i>	arroyo willow	Riparian			Chaparral
Salicaceae	<i>Salix lucida</i> ssp. <i>lasiandra</i>	shining willow	Riparian			
Saxifragaceae	<i>Lithophragma heterophylla</i>	hillside woodland star	Oak Woodland			Oak/Bay Forest
Scophulariaceae	<i>Pedicularis densiflorus</i>	Indian warrior	Oak Woodland			Oak/Bay Forest Chaparral

Permanente Quarry: Observed Plant List

Family	Scientific name	Common name	Habitat			
Scrophulariaceae	<i>Antirrhinum kelloggii</i>	Kellogg's snapdragon				Oak/Bay Forest
Scrophulariaceae	<i>Castilleja affinis</i>	indian paintbrush	Oak Woodland		Disturbed	Chaparral
Scrophulariaceae	<i>Castilleja densiflora</i>	dense owl's clover		Grassland	Disturbed	Chaparral
Scrophulariaceae	<i>Castilleja exserta</i>	purple owl's clover		Grassland	Disturbed	Chaparral
Scrophulariaceae	<i>Castilleja foliolosa</i>	woolly paintbrush	Oak Woodland		Disturbed	Chaparral
Scrophulariaceae	<i>Collinsia heterophylla</i>	Chinese houses	Oak Woodland			Oak/Bay Forest
Scrophulariaceae	<i>Cordylanthus rigidus</i> ssp. <i>rigidus</i>	rigid bird's beak				Chaparral
Scrophulariaceae	<i>Keckiella cordifolia</i>	climbing penstemon				Chaparral
Scrophulariaceae	<i>Kickxia elatine</i>	sharp leaved fluellin	Oak Woodland			Oak/Bay Forest
Scrophulariaceae	<i>Linaria maroccana</i>	Moroccan toad flax			Disturbed	
Scrophulariaceae	<i>Mimulus aurantiacus</i>	bush monkey flower	Oak Woodland		Disturbed	Chaparral
Scrophulariaceae	<i>Mimulus cardinalis</i>	cardinal monkey flower	Riparian			Oak/Bay Forest
Scrophulariaceae	<i>Mimulus guttatus</i>	seep monkey flower	Riparian	Oak Woodland		Oak/Bay Forest
Scrophulariaceae	<i>Penstemon centranthifolius</i>	scarlet bugler	Oak Woodland		Disturbed	
Scrophulariaceae	<i>Penstemon heterophyllus</i> ssp. <i>heterophyllus</i>	foothill penstemon			Disturbed	Chaparral
Scrophulariaceae	<i>Scrophularia californica</i>	beeplant	Oak Woodland			Oak/Bay Forest Chaparral
Scrophulariaceae	<i>Veronica anagallis-aquatica</i>	water speedwell	Riparian	Oak Woodland	Grassland	
Scrophulariaceae	<i>Veronica persica</i>	speedwell	Oak Woodland	Grassland	Disturbed	
Solanaceae	<i>Datura stramonium</i>	jimson weed	Oak Woodland			Oak/Bay Forest Chaparral
Solanaceae	<i>Solanum elaeagnifolium</i>	silverleaf nightshade			Disturbed	
Solanaceae	<i>Solanum umbelliferum</i>	blue witch nightshade	Oak Woodland			Oak/Bay Forest Chaparral
Sterculiaceae	<i>Fremontodendron californica</i>	flannel-bush	Oak Woodland	Grassland	Disturbed	
Taxaceae	<i>Torreya californica</i>	California nutmeg	Riparian			Oak/Bay Forest

Permanente Quarry: Observed Plant List

Family	Scientific name	Common name	Habitat		
Taxodiaceae	<i>Sequoia sempervirens</i>	redwood			Oak/Bay Forest
Typhaceae	<i>Typha angustifolia</i>	narrow-leafed cattail	Riparian		
Urticaceae	<i>Urtica dioica</i>	stinging nettle	Riparian	Oak Woodland	Oak/Bay Forest
Verbenaceae	<i>Verbena lasiostachys</i>	common vervain			Disturbed Chaparral
Violaceae	<i>Viola ocellata</i>	twoeyed violet		Oak Woodland	Oak/Bay Forest

Attachment J

Soil Mapping

Supplementary Report

Date: January 26, 2009

Subject: Topsoil depth Measurements in EMSA RPA Area, Lehigh Permanente Quarry

Methods and Results:

Existing road cut banks and soil pits in the East Materials Storage Area (EMSA) Reclamation Plan Amendment (RPA) Area were sampled to determine the depth of the topsoil (A and B Horizons). When available, the C and R Horizons were determined as well. All depths were taken in inches. Frequently, the A / B, and B / C Horizons were grouped as one where it was difficult to make a distinction between these horizons. A / B soils were deemed suitable for salvage as they had high organic content and low percentage of cobbles. Each sample point was mapped with a GPS unit and a digital photograph of each sample was taken. A table summarizing this data is included below, and a figure showing the location of each sample point is attached (Figure 1). The figure also includes the area of each vegetation community type encountered.

Fourteen (14) sample points were located and assessed in the RPA Area (Table 1). The vegetation community surrounding each sample point was noted, specifically whether the sample point occurred under oak woodland or another community type. Twenty biological communities are known from the Hanson property; however, these communities were grouped into five larger types based on soil characteristics (e.g. horizon depths, color), similar organic inputs, and similar vegetation. These communities were: oak woodland, chaparral, grassland, and unsuitable (areas where no A / B Horizon exists due to disturbance).

Based on these new communities, four (4) points were taken within oak woodland, three (3) points were taken in chaparral, and three (3) points were taken within grassland. Four (4) points were taken in habitats with substrate that were determined to be unsuitable salvage soil due to disturbance. Points taken in reclaimed areas were determined to be unsuitable salvage soils as well due to very little organic inputs and high cobble content throughout the profile. Frequently, A Horizons were not found in the chaparral communities likely due to a reduced organic input from the vegetation. Table 2 summarizes the average soil depth observed in each community in the RPA Area.

Table 1. Soil samples from the EMSA RPA Area, January 21, 2009

Sample Point	O depth (inches)	A depth (inches)	B / C depth (inches)	R depth (inches)	Habitat	Notes
P1	none	not apparent	B: 0 - 6 (est.) C: 6 - 18+	not found	chaparral	loamy clay; horizons difficult to distinguish; appears to be reclaimed
P2	none	not apparent	B: 0 - 10 C: 10 - +	not found	chaparral	appears to be reclaimed; heavy cobble below 10 inches
P3	0 - 1	1 - 10	B: 10 - 20 C: 20+	not found	oak woodland	
P4	<1	not apparent	C: 0 - 2+	not found	unsuitable (grassland)	extremely high rock content; not suitable salvage material
P5	<1	not apparent	B: 0 - 8 C: 8+	not found	chaparral	heavy cobble below 8 inches
P6	none	not apparent	B: 0 - 16 C: 16+	not found	grassland	
P7	<1	0 - 10 (A/B)	C: 10+	not found	grassland	heavy cobble below 10 inches
P8	<1	0 - 14 (A/B)	C: 14+	not found	grassland	along old road cut
P9	0 - 1	0 - 20 (A/B)	C: not found	not found	oak woodland	along old road cut
P10	<1	0 - 16 (A/B)	C: not found	not found	oak woodland	along old road cut
P11	<1	0 - 2	B: 2 - 10 C: 10 - 18+	18+	oak woodland	along old road cut
P12	<1	not apparent	not apparent	0+	unsuitable (chaparral)	soils non-native rocky fill; not suitable salvage material
P13	0 - 1	not apparent	not apparent	0+	unsuitable (oak woodland)	soils non-native rocky fill; not suitable salvage material
P14	<1	not apparent	not apparent	0+	unsuitable (chaparral)	soils non-native rocky fill; not suitable salvage material

Table 2. Average Topsoil Depth by Condensed Vegetation Community, EMSA RPA Area

Habitat	Area (acres)	Average Soil Depth (inches)	Standard Deviation
unsuitable ¹	59.3	N/A	N/A
oak woodland ²	8.3	17	4.7
chaparral ³	13.1	8	2.0
grassland	8.3	13	3.1
suitable habitat (total)	29.7	N/A	N/A
Reclamation Plan Area (total)	89	N/A	N/A

¹unsuitable includes non-vegetated or extremely disturbed areas, and revegetated areas determined to be unsuitable

²oak woodland includes oak scrub

³chaparral includes northern mixed chaparral, mixed scrub, poison oak scrub, and chamise chaparral

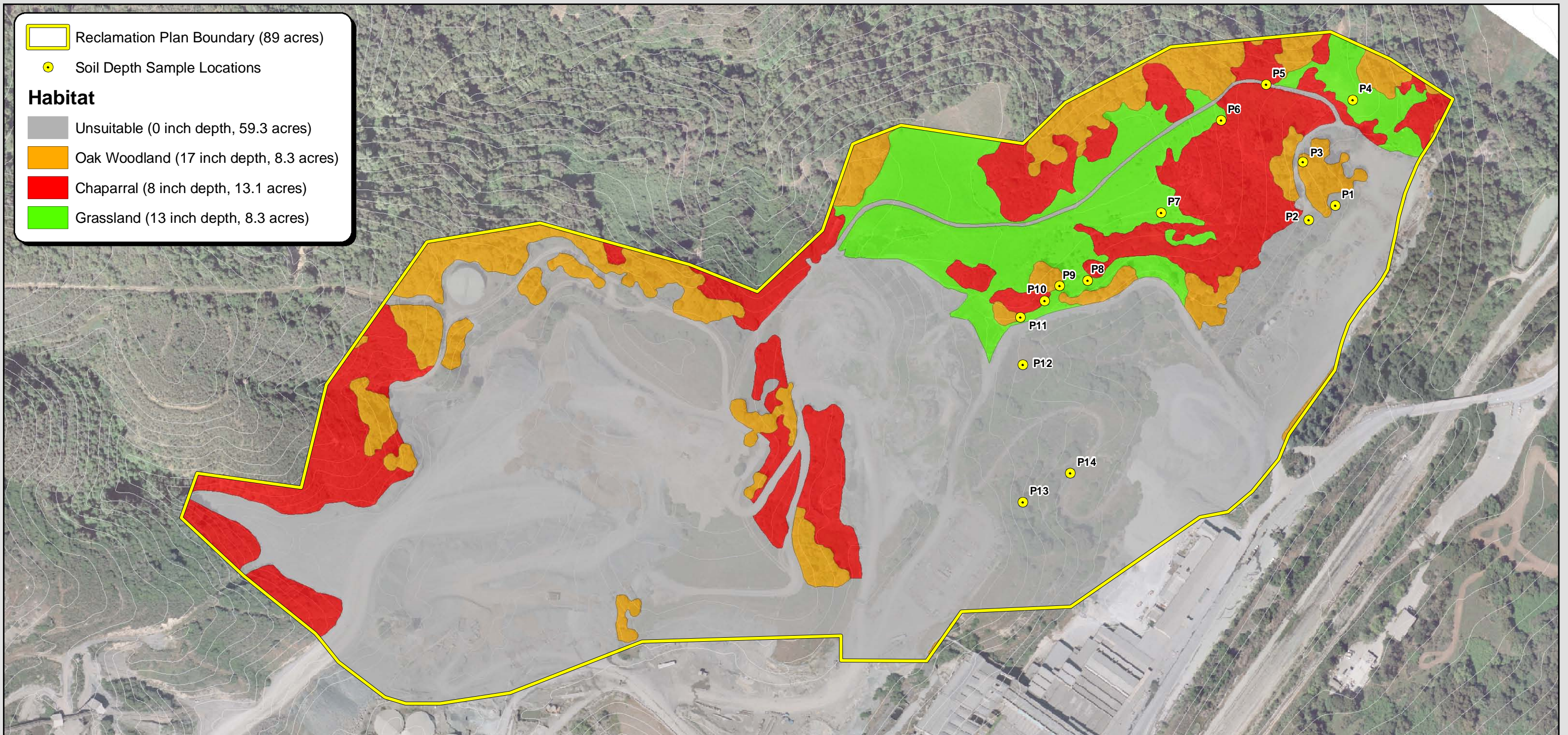
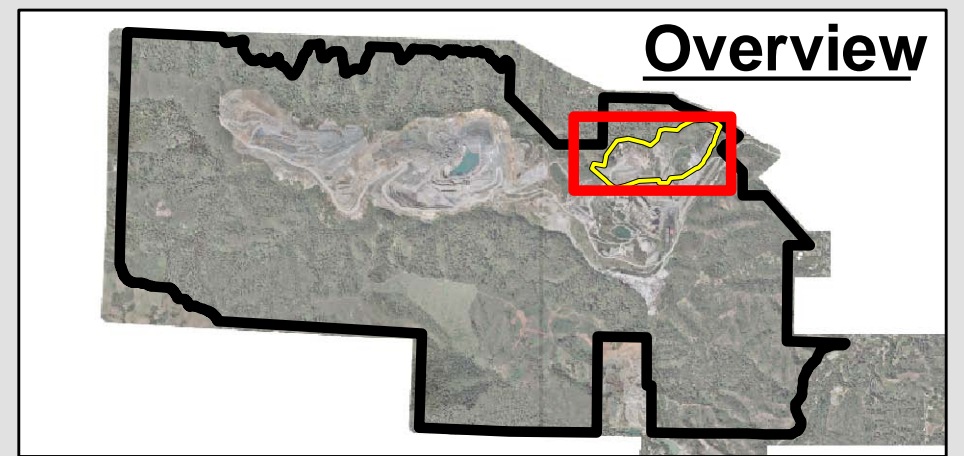


Figure 1. Soil Sample Locations
 East Materials Storage Area
 Lehigh Permanente Quarry,
 Santa Clara County, California

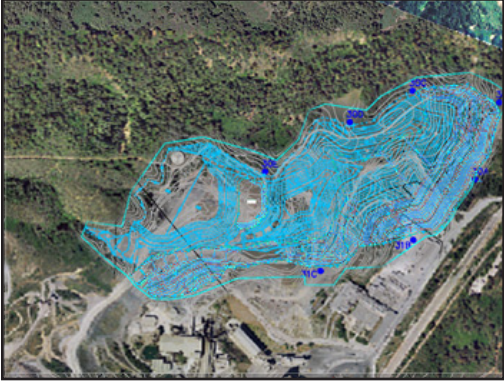


Attachment K

Sequential Visual Simulation



Existing View (Current Condition)



Note: This visual simulation utilizes computer technology (CADD/digital photo simulation) to translate the 2-dimensional engineering plans and landscape concepts into a composite 3-dimensional image, so as to depict the conceptual overall appearance of the project from the designated locations. The model shows proposed development at maximum building height for each use. Actual elevations will be set by tract map grading plans.

KEY MAP: Current Condition

Permanente Creek Phasing Analysis

Lehigh Heidelberg Cement Group

April 16th 2009

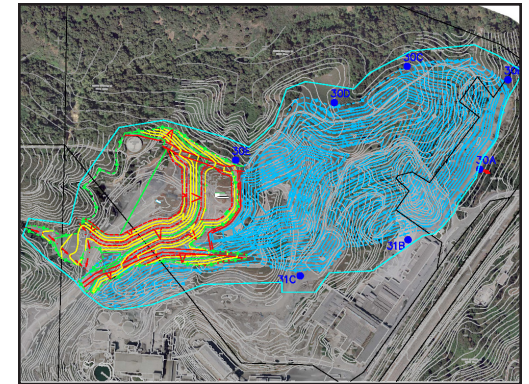
3d visualization
interactive media
web development
print collateral
video production



www.visuart.com 949.756.8700



Phase - A



Note: This visual simulation utilizes computer technology (CADD/digital photo simulation) to translate the 2-dimensional engineering plans and landscape concepts into a composite 3-dimensional image, so as to depict the conceptual overall appearance of the project from the designated locations. The model shows proposed development at maximum building height for each use. Actual elevations will be set by tract map grading plans.

KEY MAP: Phase - A



Permanente Creek Phasing Analysis

Lehigh Heidelberg Cement Group

April 16th 2009

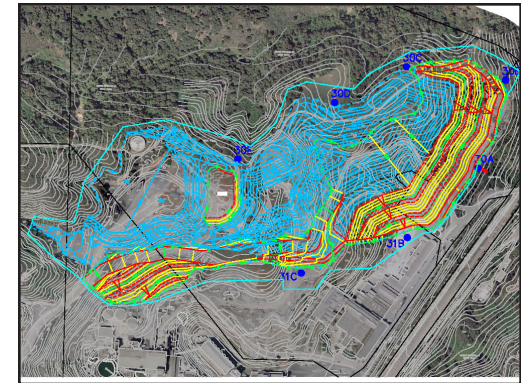
3d visualization
interactive media
web development
print collateral
video production



www.visuart.com 949.756.8700



Phase - B



Note: This visual simulation utilizes computer technology (CADD/digital photo simulation) to translate the 2-dimensional engineering plans and landscape concepts into a composite 3-dimensional image, so as to depict the conceptual overall appearance of the project from the designated locations. The model shows proposed development at maximum building height for each use. Actual elevations will be set by tract map grading plans.

KEY MAP: Phase -B



Permanente Creek Phasing Analysis

Lehigh Heidelberg Cement Group

April 16th 2009

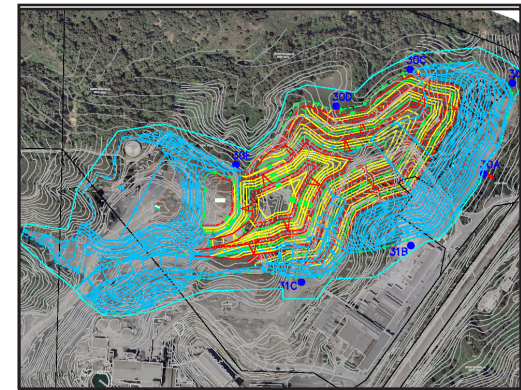
3d visualization
interactive media
web development
print collateral
video production



www.visuart.com 949.756.8700



Phase - C



Note: This visual simulation utilizes computer technology (CADD/digital photo simulation) to translate the 2-dimensional engineering plans and landscape concepts into a composite 3-dimensional image, so as to depict the conceptual overall appearance of the project from the designated locations. The model shows proposed development at maximum building height for each use. Actual elevations will be set by tract map grading plans.

KEY MAP: Phase -C



Permanente Creek Phasing Analysis

Lehigh Heidelberg Cement Group

April 16th 2009

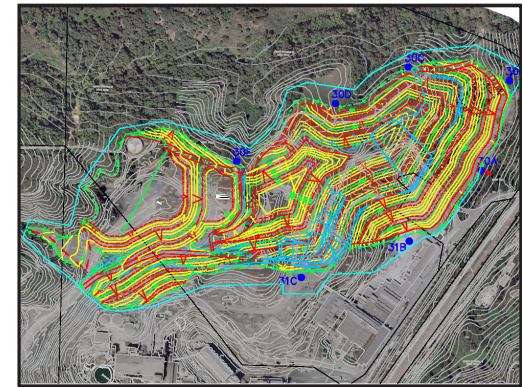
3d visualization
interactive media
web development
print collateral
video production



www.visuart.com 949.756.8700



5 Year Build-out



Note: This visual simulation utilizes computer technology (CADD/digital photo simulation) to translate the 2-dimensional engineering plans and landscape concepts into a composite 3-dimensional image, so as to depict the conceptual overall appearance of the project from the designated locations. The model shows proposed development at maximum building height for each use. Actual elevations will be set by tract map grading plans.

KEY MAP: 5 Year Build-out



Permanente Creek Phasing Analysis

Lehigh Heidelberg Cement Group

April 16th 2009

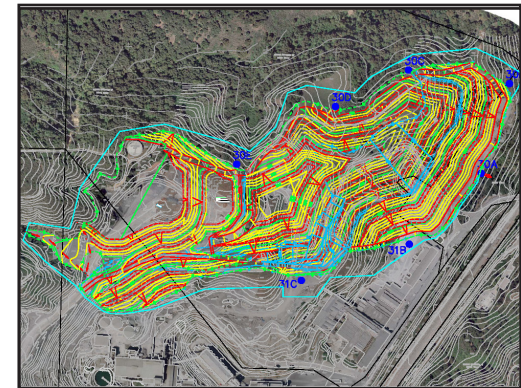
3d visualization
interactive media
web development
print collateral
video production



www.visuart.com 949.756.8700



10 Year Build-out



Note: This visual simulation utilizes computer technology (CADD/digital photo simulation) to translate the 2-dimensional engineering plans and landscape concepts into a composite 3-dimensional image, so as to depict the conceptual overall appearance of the project from the designated locations. The model shows proposed development at maximum building height for each use. Actual elevations will be set by tract map grading plans.

KEY MAP: 10 Year Build-out 

Permanente Creek Phasing Analysis

Lehigh Heidelberg Cement Group

April 16th 2009

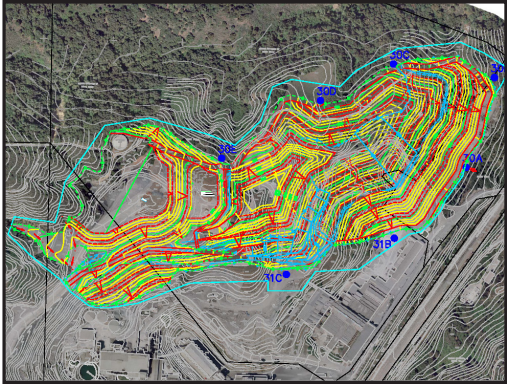
3d visualization
interactive media
web development
print collateral
video production



www.visuart.com 949.756.8700



20 Year Build-out



Note: This visual simulation utilizes computer technology (CADD/digital photo simulation) to translate the 2-dimensional engineering plans and landscape concepts into a composite 3-dimensional image, so as to depict the conceptual overall appearance of the project from the designated locations. The model shows proposed development at maximum building height for each use. Actual elevations will be set by tract map grading plans.

KEY MAP: 20 Year Build-out 

Permanente Creek Phasing Analysis

Lehigh Heidelberg Cement Group

April 16th 2009

3d visualization
interactive media
web development
print collateral
video production



www.visuart.com 949.756.8700

Attachment L

1985 Reclamation Plan

RECLAMATION PLAN
KAISER CEMENT
PERMANENTE QUARRY

FOR:
SANTA CLARA COUNTY
OFFICE OF PLANNING

DEPARTMENT OF PLANNING AND DEVELOPMENT

PREPARED BY:

RUTH AND GOING, INC.

OCTOBER, 1984

JOB NO. 16803

COUNTY OF SANTA CLARA
PLANNING DEPARTMENT
APPROVAL

Permit No. _____

START COMPLETED

APPROVED _____

SUBMITTED _____

REMARKS: _____

RECLAMATION PLAN
KAISER CEMENT CORPORATION
PERMANENTE QUARRY

I. BACKGROUND AND INTRODUCTION:

Background:

Kaiser Cement Corporation's Permanente Quarry and Cement plant is the major supplier of cement to the northern California area and major source of aggregate for Santa Clara County. The limestone quarry produces approximately 4 million tons of rock annually providing for an annual production capacity of 1.6 million tons of cement, and significant quantities of aggregates for highway, residential and industrial construction.

In conformance with County directives, the California Surface Mining and Reclamation Act, 1975, and the 1982 Santa Clara County Mining Regulations, Kaiser Cement Corporation has been, and continues to be involved in the development of reclamation plans. These plans incorporate reclamation activities into ongoing quarry operations to provide short term visual protection, and eventual long term reclamation.

Past reclamation and scenic protection activities include a landscaping plan and Ridgeline Protection Easement which were undertaken in 1972. Kaiser Cement Corporation granted a permanent easement to the County of Santa Clara to ensure the protection of the view of Permanente Ridge from the Los Altos area. This easement, granted in the form of a deed dated August 18, 1972, states that the ridge will not be lowered below the elevation of

1500 feet for the majority of its length, and not below 1650 feet for a specified area. Permanent fixed monuments physically located the easement in the field, and have been checked periodically by County staff. Work in the ridge area was successfully completed in 1975.

Several months after the Ridgeline Protection Easement was granted, Kaiser Cement prepared and implemented a landscape plan to screen the most visible areas of the Permanente quarry, and to stabilize quarried slopes. This plan, a detailed rehabilitation study prepared by Royston, Hanamoto, Beck and Abey was accepted by the County Board of Supervisors on November 28, 1982. Planting under the guidance of this plan is presently ongoing.

Introduction:

At this time, Kaiser Cement Corporation has prepared another reclamation plan to address the next 25 years of the quarry's operation. This plan will be reviewed and adopted by the County prior to its implementation. In addition to the features of the reclamation plan, this report discusses the quarry's environmental setting, and the operating characteristics of the mining operation. The entire Kaiser Cement site encompasses over 3200 acres, but the discussion in this document is focused only on portions of the 330 acre quarry area -- the location of the reclamation activity.

II. LOCATION AND SETTING

A. Location

The Kaiser Cement site is located at the western end of Permanente Road, approximately 1-1/2 miles west of the corporate limits of the City of Cupertino. The Kaiser property, including the cement plant and quarry, consists of 3268 acres situated in Sections 17 and 18, Township 7 South, Range 2 West, Mt. Diablo Base and Meridian. Of this acreage, the quarried area and subsequent reclamation comprises approximately 330 acres. The site location is shown in Figures 1 and 2.

B. Environmental Setting

The Permanente Quarry is located in the eastern foothills of the Santa Cruz mountains at the western edge of the Santa Clara Valley. Elevations in the quarry area range from 950' to 1900' above sea level with terrain comprised of hilly grassland vegetated with oak and brush. The site experiences annual temperatures ranging from roughly 35 to 100 degrees (F), with precipitation averaging 32 inches a year. Permanente Creek, a perennial stream, is located on the Kaiser property but does not pass through the quarried area.

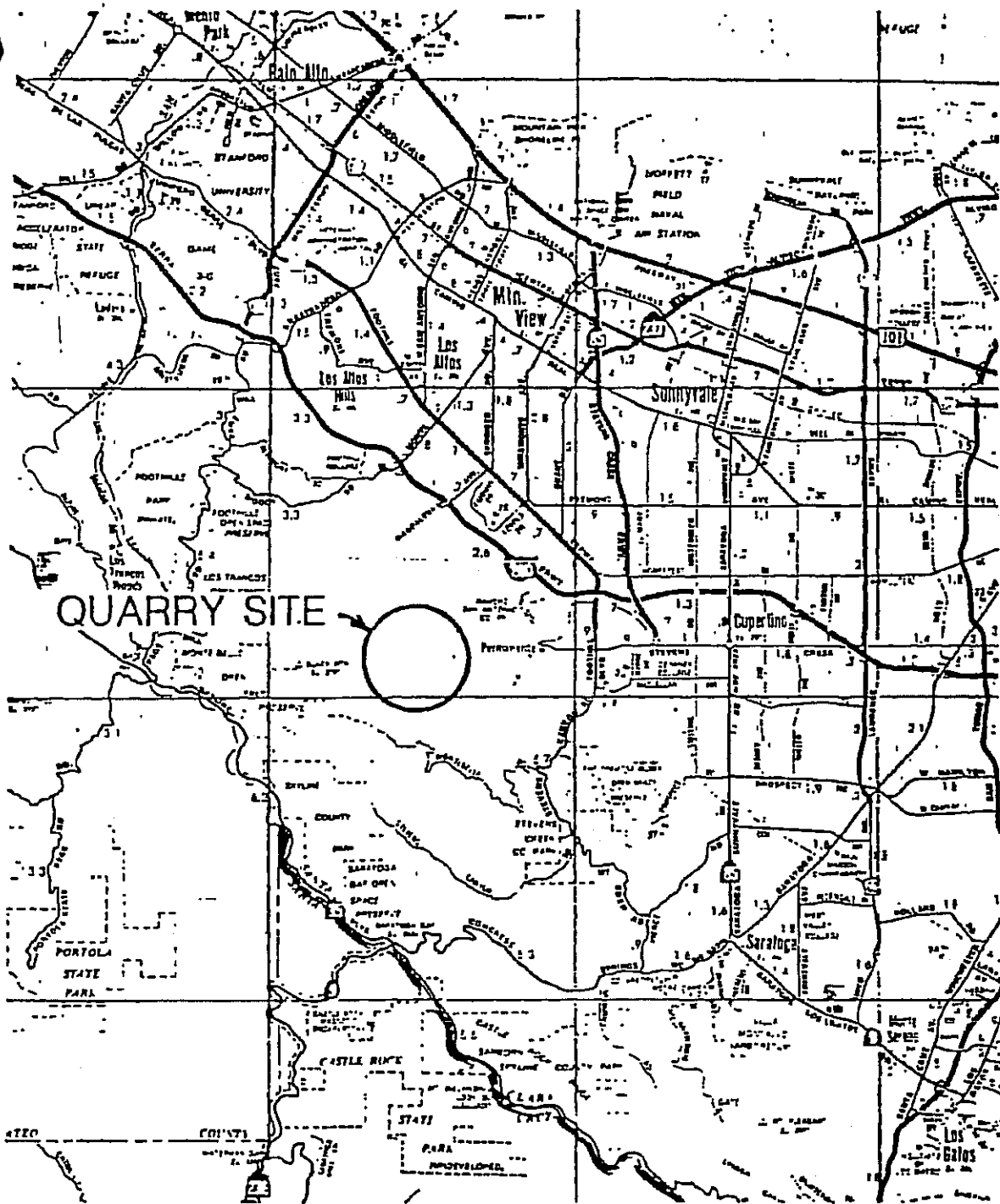
Vegetation: Varieties of vegetation on the site consist of oak woodland, oak savannah, woodland/chaparral, and chaparral habitats. The oak woodland habitat occurs on well drained slopes and flatlands, and consists of open to dense stands of oak trees with an understory of annual grasses, herbs, and low shrubs such as poison oak, coffee berry and coyote brush. The California live oak is one of the oak species on the site.

This species is a slow growing variety of oak, but one that can survive for hundreds of years.

There are no rare or endangered plant species expected to be present in the area. The nearest recorded location of rare and endangered plant species is in the coastal foothills of the Santa Cruz mountains, some 15 miles away.

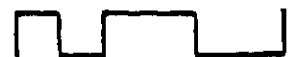
Wildlife: The oak woodland vegetative group provides a valuable habitat for a variety of birds, reptiles, and mammals, as well as refuge for larger animals such as deer and coyote. Known and expected wildlife on the site include the Mule deer, coyote, raccoon, bobcat, Red tailed hawk, California quail, Western fence lizard, and various snakes and amphibians.

No rare or endangered animal species are expected to inhabit the areas near the Permanente Quarry.



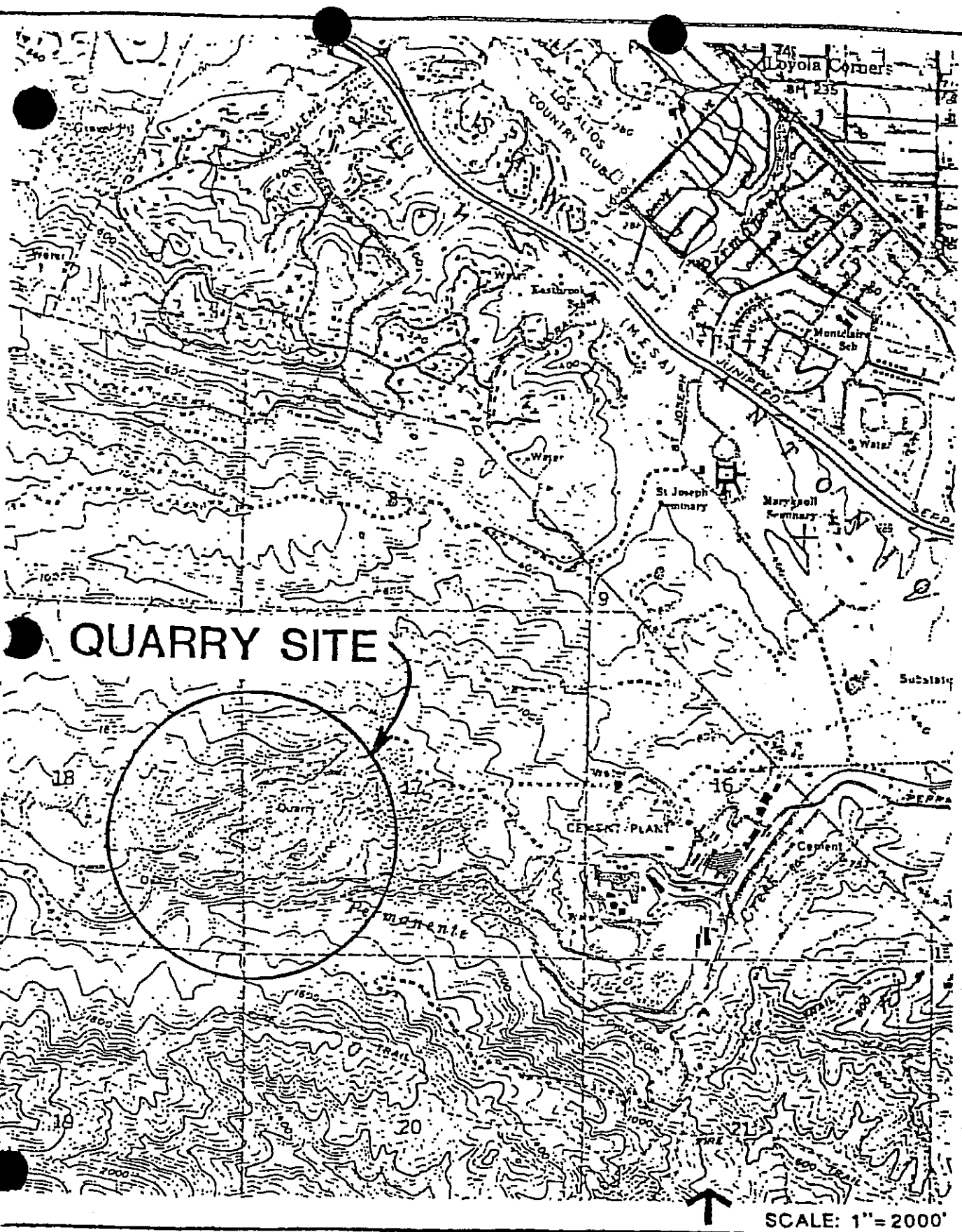
SCALE IN MILES

0 1/2 1 2 3



LOCATION MAP

FIG. 1

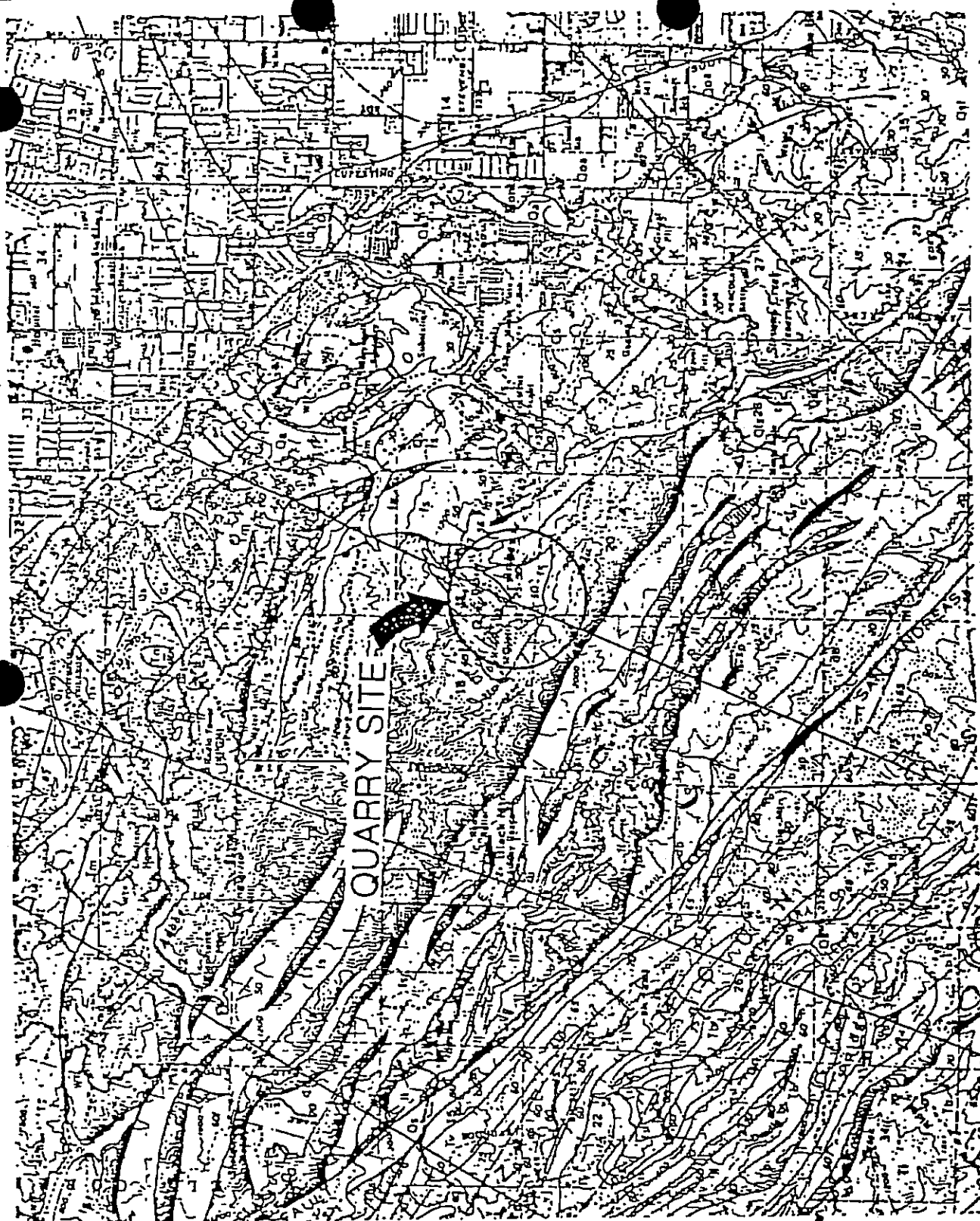


VICINITY MAP

FIG. 2

C. Geology

The limestone quarried at Permanente is considered to be one of the units of the Jurassic-Cretaceous age Franciscan Complex. The limestone unit is locally referred to as the Calera limestone. The Permanente deposit is by far the largest limestone body known to exist in a number of discontinuous masses of limestone that crop out along a northwest-southeast trending zone in the central and southern San Francisco peninsula area of the Coast Ranges. The limestone deposit in the quarry is associated with Franciscan graywacke, sandstone, red chert, diabase and greenstone, all of which are exposed in the quarry area. Further to the east, in the vicinity of the cement plant, the Franciscan is in contact with the younger Plio-Pleistocene Santa Clara Formation. As indicated on Figures 3A and 3B, the quarry areas pertaining to this reclamation plan are completely underlain by the Franciscan.



QUARRY SITE

←
SCALE: 1" = 4000'

GENERAL GEOLOGY MAP

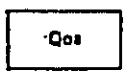
FIG. 3A

of FIGURE 1

Qs	Qm	Qls
----	----	-----

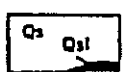
Surficial sediments
 Qs, alluvium;
 Qm, bay mud and clay;
 Qls, landslide rubble.

UNCONFORMITY



Older alluvium

UNCONFORMITY



Santa Clara Formation
 Qs, gravel;
 Qsl, lake beds

UNCONFORMITY



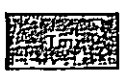
Merced(?) Formation

UNCONFORMITY

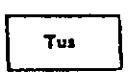


Purisima Formation

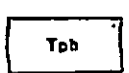
UNCONFORMITY



Monterey Shale



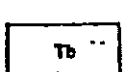
Unnamed sandstone



Page Mill Basalt



Mindego Basalt



Basalt and diabase



Lambert Shale

QUATERNARY

TERTIARY

Pliocene

Pliocene

Miocene

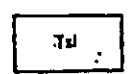
Oligocene

Eocene

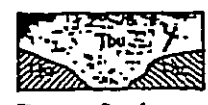
Cretaceous



Vaqueros Sandstone



San Lorenzo Formation



Butano Sandstone
 Tbu, sandstone;
 Tbs, shale;
 Tbc, basal conglomerate



Unnamed shale



Serpentine



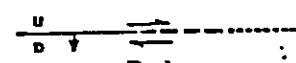
Diabase



Franciscan Formation
 fs, sandstone or graywacke;
 fh, shale;
 fl, limestone;
 fc, chert;
 fg, greenstone;
 fu, undivided rocks (Shown in sections only)

Contact

Dashed where gradational or approximately located



Fault

Dashed where indefinite or of doubtful existence; dotted where concealed. U, upthrown side; D, downthrown side. Parallel arrows indicate relative lateral movement; single arrow indicates dip of fault plane



Anticline

Syncline

Fold, showing surface position of axis and direction of plunge

Dashed where approximately located

Inclined Vertical Overturned
 Strike and dip of beds

CRETACEOUS

GENERAL GEOLOGY LEGEND

FIG. 3E

Geologic work has been performed in the Permanente quarry and surrounding area by Kaiser personnel, consultants, and outside interests such as universities and state and federal geologic surveys. A complete reference listing of geologic reports, published is presented as Appendix A to this report. In addition, there have been more than 700 exploratory test holes drilled at Permanente along with numerous "in-house" geologic maps and cross sections prepared since Kaiser Cement Corporation began operating this deposit in 1939.

Table 1 indicates the location of the Permanente quarry relative to active and potentially active faults in the region. Of the faults listed, the strike-slip San Andreas fault is considered capable of producing a great earthquake equal to the 1906 San Francisco Earthquake.

Among the faults that may directly affect the subject area, the Sargent-Berrocal Fault Zone, as described in the literature, is a northwest trending zone of reverse and thrust faults extending from San Juan Bautista north to Permanente and then to Palo Alto, where it appears to join the San Andreas Fault. At Permanente, the main trace appears to trend northward under Permanente Creek where the creek forms a one-half mile N30W-trending, linear valley in a zone between the cement plant

ACTIVE AND POTENTIALLY ACTIVE FAULTS AND THEIR EARTHQUAKE CHARACTERISTICS

Causative Faults	Distance and Direction from Permanent Quarry	Maximum Historical Earthquake Magnitude (Richter Magnitude)	Maximum Probable Earthquake Magnitude (Richter Magnitude)	Est. Recurrence Interval of Max. Prob. Earthquakes
San Andreas	2 Miles West	8.3 (Last event: 1906)	8.3	50-200 Years
Hayward	16 Miles East	7.0+ (Last event: 1868)	7.0	10-100 Years
Calaveras	19 Miles East	6.0+	7.0	10-100 Years
San Gabriel	1/2 Mile East (Main segment) (Branch exposed in quarry)	3.7 to 5.0	6.5 to 7.0	Data insufficient for estimating
San Jacinto	1 1/2 Miles East	2.0 to 3.0	6.5 to 7.0	Data insufficient for estimating

SOURCE: Seismic Safety E. ment
City of America

TABLE 1

and the quarry. There is a significant difference between bedrock types on opposite sides of this linear valley, with the southeastern block predominantly Santa Clara formation and the northeastern block composed of Franciscan complex rocks. A northwesterly trending branch of this main Berrocal fault segment does appear to split off through the quarry. This is observed in the quarry as a series of northwest trending shear zones within the limestone.

The present activity of the Berrocal zone in the Permanente area is speculative. There is no evidence to date, that indicates the fault has offset recent sediments within the local area, although microseismicity near Stevens Creek Reservoir, about 2 miles southeast, suggest that the fault may be potentially active.

The possible seismic hazard to the Permanente quarry and surrounding area is the potential for severe ground shaking from a major event on the San Andreas. Secondary effects due to this strong ground motion would be ground failure such as landsliding, ground settlement, ground cracking and rock falls. Due to local differences in the geologic and topographic conditions, variations of ground shaking intensity are to be expected from place to place. If a significant earthquake event occurs on the San Andreas, effects in the quarry may include localized rock falls on quarry faces, ground cracking on benches close to adjacent quarry faces, or local slumping or sliding of less competent materials such as the serpentized greenstone area in the upper northwest portion of the quarry. Due to the nature of the hard rock materials and existing pit slope angle of 45° in the quarry, it is unlikely that significant ground failure will occur. Effects to the

rock storage areas will most likely be ground settlement and local slumping of exposed faces. The very coarse rock material in these storage areas will preclude any failure due to liquefaction. Neither area (quarry or rock storage) supports any buildings or man-made structures.

D. Mineral Deposit

The Calera limestone at Permanente covers an irregular triangular area with an approximate exposed length of one mile and width of two-thirds of a mile. The limestone unit is tabular in nature with an exposed thickness of at least 800 feet. The section is composed of thin limestone beds and interbedded chert. The limestone is made up of continuous beds of uniform thickness that can be traced the entire length of outcrops. The thickness of most beds ranges from 2-6 inches. Chert lenses are of the same range in thickness but are not continuous. Over only a few feet of section, chert may be absent or form up to 50% of the rock.

The limestone deposit is divided into two units that include a lower black limestone and an upper white limestone. The lower unit is largely recrystallized and bituminous, with about 2% organic matter. Less recrystallized parts contain some nannofossils. Larger microfossils are radiolarian molds occurring in both limestone beds and chert lenses. The upper white limestone is stratigraphically above the lower black limestone (based on geopetal features and graded bedding). It is less recrystallized than the lower unit, lacks bituminous matter and contains more chert lenses, and has planktonic Foraminifera in addition to Radiolaria. No burrowing or primary sedimentary structures or megafossils are present. The

best estimate of the age range in the light limestone till now is mid-late Cretaceous (late Turonian, 88 million years) in the upper light limestone to late, lower Cretaceous (Albian, 105 million years) in the lower part of the light limestone, based on recent work by the U.S. Geological Survey. Dateable fossils have not been found in the lower, black limestone.

Stratigraphic relations of the two limestone units have been extensively studied. Problems with interpretations have been related to extensive thrust and high angle faulting causing repetition and omission of strata. Recent work, as indicated on Figure 4, suggests that the two limestone units, the upper white and lower black limestones, are repeated by thrust faulting into two blocks. The upper limestone unit is split by a diabase sill, approximately 80 feet thick. The sill occurs only in the upper thrust block. A few volcanic ash horizons 20-40 cm thick are found interbedded with the upper white limestone, although recent interpretations suggest that these layers may be a clayey fault gouge related to thrust faulting. The limestones are in fault contact, both at the top and bottom of the section with Franciscan rocks, greenstones, graywacke, and serpentized greenstone, which are exposed in the quarry.

STRATIGRAPHIC SECTION
PERMANENTE QUARRY

Geologic Map Symbol	Approximate Thickness (ft)	Rock Name	Geologic Description
K ₇ / K _{6a}	30 - 70 (variable)	Franciscan Volcanics, Sandstone	Altered calcareous basalt, gneiss, and graywacke sandstone.
K ₅	20 - 30	Upper White, w/o shert	White to light gray, fine- medium crystalline lime- stone. Trace of shert lenses.
K ₄	110 - 115	Upper White, w/shert	White to medium gray, very fine-fine crystalline limestone. Numerous lenses and bands of medium dark gray shert.
K ₃	60 - 100	Diabase	Greenish gray, medium crystalline, massive, diabase silt.
K ₂	100 - 150	Lower White	Light gray to brownish gray, fine crystalline limestone with varying amounts of banded gray to dark gray shert.
K ₁	200 - 250	Lower Black	Medium to dark gray, medium crystalline limestone with traces of dark gray shert bands. Franciscan near.
LAKES			
K ₁	100 - 110	Upper White.	White to medium gray, very fine-fine crystal- line limestone. Light gray to dark gray shert bands parallel to bedding.
K ₂	50 ±	Lower Black	Medium to dark gray, medium crystalline limestone, with occasional shert bands.
LAKES			
K ₇ / K ₇	unknown thickness	Franciscan volcanics, gneiss, and serpentinite	Basalt, buff, gray- wacke sandstone, and serpentinitized peridotite.

10/53 BAR

Structurally the limestone body is complicated by faults and folds, but generally dips 25° to 35° SE. The section is highly jointed and both types of limestone are strongly fractured. Joints are mostly perpendicular to bedding.

Exposures in the quarry indicate that at least three thrust faults roughly parallel to bedding slice the deposit. Subsequent high angle faulting, possibly related to the Berrocal Fault system trends generally NW.

The chemical quality of each limestone unit varies considerably. The upper, light limestone averages 80% calcium carbonate (CaCO_3) or more, but varying amounts of chert lenses lowers the bulk CaCO_3 to 70% or less when mined. The upper portion of this unit has lesser amounts of chert and has higher carbonate values. The lower, black limestone averages 87% CaCO_3 ranging from more than 90% to less than 80% in individual layers. Variations also occur near contacts and where chert interbeds are common. Both limestone units exhibit a decrease in CaCO_3 values in shear and fault zones that bisect the deposit. Four grades of rock are presently used for quarry development: (1) high grade - dark gray limestone unit with CaCO_3 values greater than 85%; (2) medium grade - mixture of light and dark limestone running between 70 to 85% CaCO_3 ; (3) low grade - mainly light gray limestone with chert lenses ranging 50-70% CaCO_3 ; and (4) non-limestone rock types such as the diabase, Franciscan volcanics and sediments, fault gouge, and soil overburden. The high and medium grade limestone is principally used in the manufacture of cement while the low grade limestone and harder Franciscan rock types are used in the production of crushed rock for aggregate.

Small amounts of Franciscan volcanics and sedimentary rocks are used as a clay additive in the cement-making process, depending upon the respective chemistry of each rock type.

E. Historic Land Use

The earliest recorded activities on the site indicate that, by 1899, a wagon road had been constructed along much of the length of Permanente Creek to gain access to the limestone. The State Mineralogist's report of 1906 records that limestone quarrying along the creek took place at least as early as 1903. The sugar beet industry was an early stimulus for limestone extraction, later followed by the tremendous urban growth in the Bay Area.

The Kaiser Corporation acquired the site in the late 1930's and began quarrying and cement processing in 1939. The operation began as a two-kiln, wet process plant which expanded, after World War II to six kilns. In 1982, the original kilns were replaced with a single 1.6 million ton dry process kiln.

III. MINING OPERATIONS

A. Mined Lands

For the next 25 years, the existing and planned excavation and storage areas will encompass approximately 330 acres.

The materials storage areas are located just west and east of the quarry. The west site is used for maintaining a supply of material which currently is not used for the production of cement. This material includes low-grade limestone, and other rock types excavated from the quarry. It is expected that these lower grade limestone and rock materials will be used in the future when scarcity of the materials increase their marketability. The east site is comprised of an existing pile of rock materials which will be relocated further to the east and revegetated. This will allow the limestone beneath to be excavated while maintaining a knoll as a visual buffer between the quarried area and the Santa Clara Valley area. Figure 5 shows the quarry and both material storage areas.



FIG. 5

QUARRY PIT AND STORAGE AREAS

B. Operations

The Permanente Quarry utilizes an open pit technique to extract the limestone and associated rock materials. This procedure generally is: 1) any topsoil overburden is removed and stockpiled for future use, 2) haulage roads are developed to the planned benches, 3) blast holes are drilled in the rock with rotary blasthole drills, then controlled electric blasting loosens the rock at a benching interval of 50 feet, 4) front-end loaders and electric shovels load the broken rock into 65-ton off-highway haul trucks to be transported to the primary crusher located at the southeastern edge of the quarry. From there, the crushed rock is transported, for further processing, to the cement plant further to the east. Other rock types, and limestone not currently utilized in cement manufacture are either crushed and conveyed to the commercial rock plant or hauled directly to the materials storage area for potential use in the future.

The quarry operates year-round, five days a week, two shifts a day, although the schedule is subject to variations due to market conditions or maintenance periods.

The design for the reclamation plan is shown in Figure 6, which presents the excavation contours overlain on the existing topography. The overall pit slope for both the existing and future operations will be maintained at an angle of 45 degrees (1:1).

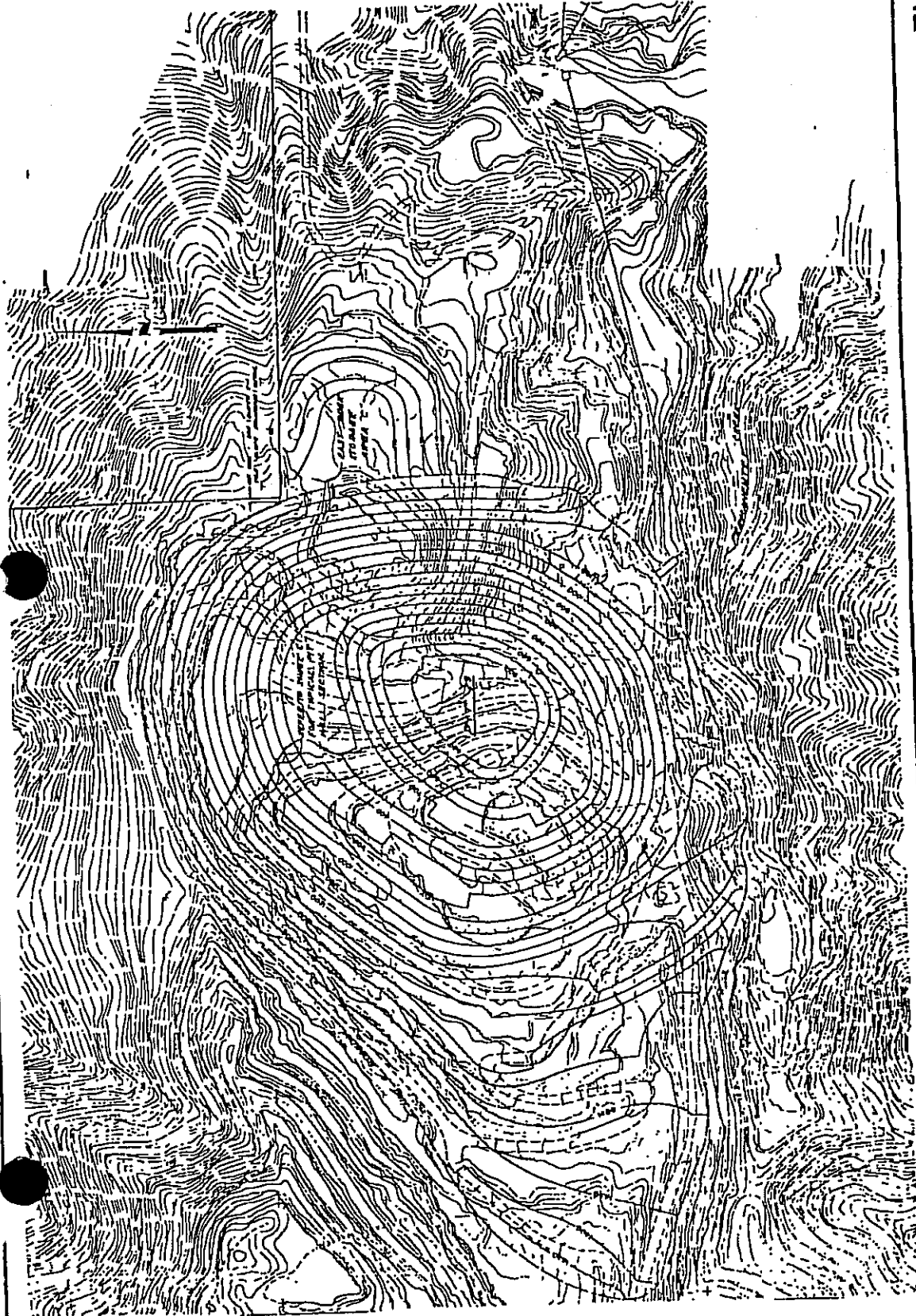


FIG. 6

QUARRY PIT DESIGN

A slope stability study for the quarry area, which is summarized in Appendix B, indicates that the 1:1 slope design is well within recommended features for slope stability.

The West Materials Storage area, contains the stockpiled rock materials and currently nonmarketable limestone. This material is maintained at a 3:1 gradient in order to achieve slope stability. Beyond the timeframe of this reclamation plan, it may eventually be sold or utilized in the reclamation process.

The East Materials Storage area will be similarly established.

C. Public Health and Safety

On-site dust related to mining operations is controlled by spraying the haul roads with water mixed with a commercial dust suppressant. Runoff collected in the quarry supplies some of the water for this use.

Blasting operations are conducted only by state licensed personnel to ensure that the procedures meet or exceed the requirements of Cal-OSHA.

For safety and security reasons, the public is barred access to the site by gates located on Permanente Road at the cement plant area.

IV. RECLAMATION

A. Timeframe

The reclamation plan presented is intended for a 25 year period. It addresses erosion control and maintenance of the West Materials Storage area, and reclamation and revegetation of the East Materials Storage area, allowing this area to serve as a visual buffer between the quarry and the Santa Clara Valley. Ultimate reclamation of the pit area, or treatment of future quarry operations, will be addressed in a revised reclamation plan to be submitted around the year 2005 when this reclamation phase nears completion. Since market demand for cement partly determines the rate of limestone extraction, this estimate may be subject to some modification in the future, in response to demand for the product.

Present mining plans for the quarry call for a 25 year period of operation. Inferred limestone reserves are estimated to support an operation of this magnitude for up to 50 years. Beyond this period the quarry could continue to operate as a crushed stone source for construction aggregate. Thus, the time span of the total life of the operation is only an estimate and is subject to future modification in response to actual market and quality conditions.

B. Phasing

West Materials Storage Area

The West Materials Storage area will be built up, contoured, and revegetated as quarrying operations generate overburden and

excess rock material. Within the storage area, the build up of material is expected to occur roughly in three phases: Phase 1 will bring the material pile up to the 1800 foot contour; Phase 2 will add another 100 feet in elevation to reach the 1900 foot level; Phase 3 will bring portions of the material to elevations of 1950 to 1975 feet, contoured to achieve both slope stability and a natural appearance in relation to the surrounding terrain.

All surfaces will be revegetated when they reach their ultimate grade. Phase 1, 2 and 3 are expected to be executed in 10, 20 and 25 years, respectively. Some modifications to the timing may result in relation to the rate of quarrying activity.

Runoff in the storage area is currently directed to catchment areas which collect sediment. The high percentage of rocks and granular material in the storage area allow rapid percolation by the runoff. As Phase 1 of the material storage nears final grade, the runoff will be directed along the new access road. The runoff will be caught in a sedimentation basin as shown on the reclamation plan. The basin and outfall will be constructed prior to the completion of Phase I.

East Materials Storage Area (Area C)

In this area the slope between contours 1400 and 1420 will be revegetated first, other areas will be planted as material becomes available for placement.

After the proposed grades have been reached for an area, 4 inches of soil will be added where practical and plant materials installed. The plant materials and planting

techniques used will be tailored to the specific area to be revegetated.

West Materials Storage Area (Area A)

The West Storage Area, because the rock material here may be used in the future, will be revegetated using seed material applied within a hydromulched slurry mixed together with fertilizer. No woody tree or shrub materials will be used in this mix, however tree species found on-site will establish themselves naturally over the 25 year period.










The purpose of the seven species of grass and wildflower seed within this mix is to stabilize the slopes and prevent erosion. Use of the seed materials selected promotes reseeding and does not require the use of supplemental irrigation.

Revegetation of the East Storage Area will utilize significantly more plant materials and different planting techniques. More extensive tree and shrub plantings will be used to incorporate the new hill into the surrounding natural setting. These plantings will include two types of oak seedlings, coyote brush, ceanothus and buckwheat seedlings, as well as a seed mix containing four different grass and wildflower species. Figure 7 presents the proposed revegetation scheme in this area.

To insure survival of the tree and shrub seedlings, protective screening is proposed to protect the vegetation from deer and rodents. Six-foot high "Poultry Net" fencing will be used to protect seedlings from deer. In addition, a portion of the oak seedlings will be protected individually by fine mesh screening to prevent damage from rodents.

Although native plant species have been selected for revegetation, some supplemental, temporary irrigation will be required due to conditions at this particular location. The high porosity of the soil, and the predominance of southern and western exposures contribute to a very dry environment for seedlings to develop. Therefore, supplemental irrigation will be provided for approximately 5 years, until the plants are fully established. An existing irrigation system will be expanded and utilized to provide water to the East Storage Area revegetation.

LEGEND

	AREA TO BE REVEGETATED	210
	SOURCE OF TOP DRESSING MATERIAL	180
	DEER FENCING	210
	PLANT LEGEND	
	COMMON BUCK BRUSH	180
	COYOTE BRUSH	210
	LEATHA OAK	210
	COYOTE BRUSH WILD BUCKWHEAT	480
	HYDRATED MIX	
	TOTAL	1210

NOTE

EACH PLANT SPECIMEN WITHIN FENCED AREA CONTAINS 40 SEEDLINGS.

EACH PLANT SPECIMEN OUTSIDE FENCED AREA CONTAINS 28 SEEDLINGS FOUR HAVE NO.

PLANT AREA TO BE REVEGETATED SHALL BE COUNTED AS 1420 OTHER AREAS SHALL BE PLANTED AS PER OPERATIONS ARE COMPLETED.

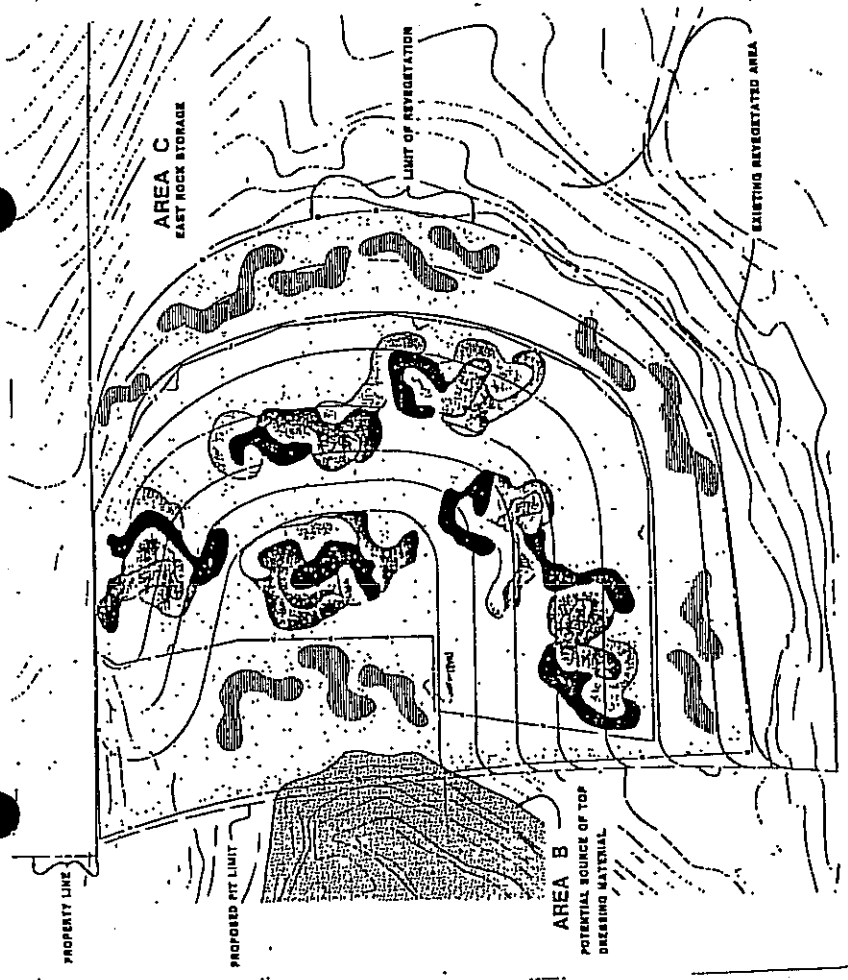


FIG. 7

REVEGETATION PLAN EAST MATERIALS STORAGE AREA

In addition to fencing protection and irrigation, all revegetation materials will be fertilized. For hydroseeded/mulched materials a totally organic, water soluble fertilizer will be used within the slurry. In the case of seedlings, slow release, long term tablets will be placed within the root zone to provide fertilization over the following two years.

The overall intent of the revegetation plan proposed is to provide the proper conditions to promote healthy mature plantings that will be similar to the surrounding native vegetation.

To further insure that the revegetated plantings will survive and grow to mature sizes, the Kaiser Cement Corporation intends to monitor all installations and conduct periodic maintenance. In this way the proper plant materials, irrigation and fertilization will be insured any potential problems can be addressed early on, providing every chance for the successful revegetation of these areas.

C. Ultimate Conditions

At the end of this 25 year reclamation program the following conditions will exist. The West Materials Storage area will have reached a maximum elevation of 1975 feet. Its slopes will be established at a 3:1 gradient and planted with native grasses to control erosion.

The East Materials Storage area will have reached a maximum elevation of 1475 feet, with slopes at a 3:1 gradient. It will be revegetated with native grasses, shrubs, and trees.

The quarry pit area will be excavated at an overall gradient of 1:1 in conformance with the slope stability investigation. Any future alternatives, including revegetation and continued operation, will be addressed in another reclamation plan to be prepared in approximately 20 years.

APPENDIX A
BIBLIOGRAPHY

Contents of file kept in Permanente (Office) - Revised August 25, 1933 to include additions indicated by *.

SUMMARY - GEOLOGICAL REPORTS AND MEMORANDA ON PERMANENTE PROPERTY

DATE	TITLE	AUTHOR	CONTENT
1888	Eighth Annual Report of the State Mineralogist, "Santa Clara County"	California State Mining Bureau	Historical notes on Guadalupe deposit. Mentions bituminous limestone.
1890	Tenth Annual Report of the State Mineralogist, "Santa Clara County"	California State Mining Bureau	Historical notes: Guadalupe and Los Gatos deposits.
1894	Twelfth Annual Report of the State Mineralogist, "Santa Clara County"	California State Mining Bureau	Historical notes: Los Gatos, Guadalupe, and Wright's Ranch deposits.
1896	Thirteenth Annual Report of the State Mineralogist, "Santa Clara County"	California State Mining Bureau	Historical notes: Guadalupe and Los Gatos deposits.
1906	Structural and Industrial Materials of California, "Santa Clara County"	California State Mining Bureau	Historical notes: El Dorado Sugar Company's Quarry (=Permanente) and Los Gatos Lime Quarry.
1908	Map showing distribution of apparent intensity, known faults, routes examined	Lawson, A.C., ed., 1908 Atlas, U. S. G. S.	1:125,000 scale
1921	Report XVII of The State Mineralogist "Santa Clara County"	California State Mining Bureau Huguenin, E. & Cateño, M.O.	Historical notes: Minship Property.
1930	San Francisco Field Division Santa Clara County	California Division of Mines Franke, H.A.	Brief Regional Description - Historical Notes - Bond and Minship Properties.
1933	Limestone Deposits of the San Francisco Region	California Division of Mines Eckel, E.C.	Distribution, Composition, Historical Notes.
1933	Limestone Weathering and Plant Associations of the San Francisco Region	California Division of Mines Kelly, J.H.	Limestone soils, Plants, Vegetation.

SUMMARY - GEOLOGICAL REPORTS AND MEMORANDA, PERMANENTE PROPERTY

DATE	TITLE	AUTHOR	CONTENT
Apr 1944	Tonnage Available In The North Ridge of The Upper Quarry	Grimm, K.E., Chief Geologist, Knuth, W.J., Permanente Corporation	Notes on mining aspect.
Feb 21, 1945	Development and Operations Program For The Permanente Cement Company Quarries for the Years 1945, 1946, 1947, 1948, and 1949	Grimm, K.E., Chief Geologist, Knuth, W.J., Permanente Corporation	Mining plan, recommendations to strip and beneficiate to extend life of property.
Aug 27, 1945	Memo to J. W. Sharp	Jack, O.E., Permanente Laboratory	Drill hole analysis from Black Mountain
Sep 1945	Geological Report of McCaugher Property	Grimm, K.E., Chief Geologist Permanente Corporation	Report on surrounding properties, particularly Black Mountain region.
Nov 1946	Insoluble Residues of The Calera Limestone in Santa Clara County, California	Pantin, J.H., Stanford University M.S. Thesis	Stratigraphic correlations, Permanente geologic map and section.
Dec 4, 1946	Limestone Reserves of The Upper Quarry Area, Permanente, California	Hulin, C.D., Dept of Geology, University of California, Berkeley	Reserve study. Identifies "Andesite" as "Ofabase," different structure interpretation to Tolman (39) based on new information.
Feb 28, 1947	Memo to Sharp, Hall, Jack, Knuth	Zimmerman, Jr., John, Chief Geologist, Permanente Corporation	Report on outside areas to supplement limestone supplies - Guadalupe Dam, Los Gatos, Monte Bello, etc.
Apr 14, 1947	Letter to Lewis Timpany	Zimmerman, Jr., John, Chief Geologist, Permanente Corporation	No interest.
Jun 1947	Insoluble Residues of the Calera Limestone from Its Type Locality, Calera Valley, San Mateo County, California.	Miranda, L.J., Stanford University M.S. Thesis	Stratigraphic correlations.

SUMMARY - GEOLOGICAL REPORTS AND MEMORANDA - PERMANENTE PROPERTY

DATE	TITLE	AUTHOR	CONTENT
Jul 1947	California Journal of Mines and Geology, "Limestone in California"	California Division of Mines Logan, C.A.	Description of Limestone deposits, Permanente's operations.
Aug 6, 1950	Letter to H. J. Kaiser	Timpany, Lewis	Promotional description of Limestone on property south of Permanente.
Aug 22, 1950	Letter to Lewis Timpany	Marsh, M.A., General Manager, Permanente Corporation	No interest.
Dec 1950	The Calera Limestone in San Mateo and Santa Clara Counties, California	California Division of Mines Walker, G.W.	Special report on Calera Limestone.
1952	Cretaceous Foraminifera from the Franciscan Calera Limestone of California	Church, C. C.	Assigns middle to basal upper Cretaceous age to Calera.
Dec 30, 1954	Memo to J. M. Garoutte	Covello, A., Geologist, Permanente Corporation	Black Mountain outcrops on Emmet Burns, Crocker (now Kaiser) and Alives properties.
Nov 14, 1956 and Nov 12, 1957	Letters on Burns Property	Whitcliffe Realty, M.A. Marsh, Carlton Hallin, and J.H. Garoutte	Black Mountain properties.
Jan 15, 1958	Memo to M. A. Marsh	Stilbolt, C.B.	Crocker lands.
Apr 5, 1961	Permanente Quarry Stratigraphic Section	Towse, D.	With CaCO ₃ percent.
Jul 20, 1961	Memo to R. G. Hohnsbeen	Kennedy, J.R.	Ref to planning & development in Palo Alto/Foothills area.
Jan 9, 1963	Memo to E. B. Connors	Towse, D.	Ref to pit development to south.
1964	Floating Limestone at Permanente	Kieiber, J.C. & Melsel, G.H.	Beneficiation of low grade Limestone.

SUMMARY - GEOLOGICAL REPORTS AND MEMORANDA ON PERMANENTE PROPERTY

DATE	TITLE	AUTHOR	CONTENT
Jun 26, 1939 and Oct 13, 1939	Report on Tonnage & Composition of Limestone Available in Proposed Quarries A and B, Permanente Corporation, and Superficial Residuary Clay on The Property of The Permanente Corporation	Toisman, Prof. C. F. and Neuman, Jr., J. V., Stanford University	Original evaluation Permanente property confined to area above 1500' el. although, limestone was recognized at lower elevations. First detail mapping of rock units and structures, description of sampling, and tonnage calculation.
1941	MILLING at the Permanente Cement Plant	Kivari, A. M.	Early quarrying and milling; short summary of Toisman and Neuman report.
1942	Geologic History and Correlation of the Jurassic of Southwestern Oregon and California	Tellaferro, H. L.	Early ideas on origin and age of Franciscan and relationship to other formations of same age.
1942	Uppercretaceous Age of the "Franciscan" Limestone near Laytonville, Mendocino County, California	Thalmann, H. E.	Assigns same age to Laytonville and Calera Limestones.
Nov 1, 1942	Geological Report and Discussion of Reserve Rock Permanente Quarry Areas	Grimm, K. E., Chief Geologist, Permanente Corporation	Update on Toisman, Neuman report with new information available from operations. Further identification of limestone units. References to south side of creek.
Dec 5, 1942	Memo to Rhodes	Grimm, K. E., Chief Geologist, Permanente Corporation	Ref to Parcel 2 of Perrone Property.
1943	Franciscan-Knoxville Problem	Tellaferro, H. L.	Urges narrowing of definition of Franciscan. States that Knoxville is an upperphase of Franciscan. Discusses lithology.
Jul 1943	Black Mountain Prospect #1	Grimm, K. E., Chief Geologist, Permanente Corporation	Report - Geology, Economic Geology, plus map and section.
Oct 27, 1943	Geological Report & Discussion of Reserve in The Quarries of The Permanente Cement Company	Grimm, K. E., Chief Geologist, Permanente Corporation	Update and general confirmation of previous work.
Mar 15, 1944	Memo to B111 Sharp	Grimm, K. E., Chief Geologist, Permanente Corporation	Limestone on McLaughern Properties and adjacent area (Black Mountain).

SUMMARY - GEOLOGICAL REPORTS AND MEMORANDA ON PERMANENTE PROPERTY

DATE	TITLE	AUTHOR	CONTENT
1966	Franciscan and Related Rocks and Their Significance in the Geology of Western California	California Division of Mines and Geology, Bailey, E.H., Irwin, W.P., and Jones, D.L.	Distribution and characteristics of Franciscan limestones; relation to other rocks.
1966	Map - Geology of the Palo Alto 15' Quadrangle, Santa Clara and San Mateo Counties, California	California Division of Mines and Geology, Dibbete, Jr., T.W.	1:62,500 scale descriptive text.
1967	Electron Microscopy of Limestones in the Franciscan Formation of California	U. S. Geological Survey Garrison, R.E. & Bailey, E. H.	Distribution, characteristics, and origins of Franciscan limestones. Recognized organic origins.
1969	Preliminary Report & Geologic Guide to Franciscan Melanges of the Marro Bay - San Simeon Area California	Iso, K.J.	Description and distribution of melanges in San Luis Obispo County.
Aug 25, 1969	Mining Plan & Use Permit		For Kaiser Property in Palo Alto.
No Date	News		Fire Department access to Monte Bello Road.
1972	What is Franciscan?	Bertrand, J.O., et al.	Structural & lithologic definition of Franciscan Complex.
1973	Mixed Depositional Environments in the Franciscan Geosynclinal Assemblage	Matthews, Vincent III and Wachs, Daniel	Origin of Franciscan rocks.
1973	Preliminary Report 17 "Environmental Geologic Analysis of the Monte Bello Ridge Mountain Study Area Santa Clara County" Maps: Plate 1, 1-A, 2, 3, & 4	California Division of Mines and Geology, Robert, T.H. and Armstrong, C.F.	Tests Area! geology. Permanente deposit rock descriptions. Maps: Bedrock, surficial, fault activity and mineral resources stability.
1973	Limestone and Dolomite Resources of California	California Division of Mines and Geology, Bowen, D.E.	Occurrences, characteristics, and economics.
1973	Petrology & Depositional History of Limestones in the Franciscan Formation of California	Wachs, Daniel, U.C. Santa Cruz, Ph.D.	Electron and Petrographic microscopy of Calera Limestones at Permanente, and Laytonville

SUMMARY - GEOLOGICAL REPORTS AND MEMORANDA ON PERMANENTE PROPERTY

DATE	TITLE	AUTHOR	CONTENT
Mar 29, 1974	Petrography and Diagenesis of Franciscan Limestones	Wachs, Daniel and Hein, J.R.	Detail on Calera Limestone.
Mar 29, 1974	Letter to J. K. Walker	Ellis, V.C.	Review of J. F. Snell's quarry reserve estimates.
May 21, 1974	Memo to J. H. Lucas	McCloud, J.P.	Recommends geologic mapping of ridge across Permanente Creek from quarry.
1975	Geologic Map of the Sargent-Berrocal Fault Zone	U. S. Geological Survey, Sorg, D.H. & McLaughlin, R.J.	1:25,000 scale map; descriptions of faults, earthquakes, landslides, mineral springs.
Jan 1975	Franciscan Limestones and Their Environments of Deposition	U. S. Geological Survey, Wachs, D. & Hein, J.R.	Limestone characteristics and origin.
Jul 21, 1977	Cover Memo, Open File Report, Vicinity Map, Topographic Map, Geologic Map, and Use Permit	California Division of Mines and Geology, Stimson, Melvin G.	Evaluation of Permanente aggregate reserves.
1978	Limestone, Dolomite, and Shell Resources of the Coast Ranges Province, California	California Division of Mines and Geology, Hart, Earl V.	Includes descriptions of Monte Bello Ridge and Permanente deposits.
Feb 1980	Franciscan Limestone Geology and Resources at Permanente and New Almaden, Santa Clara County, California	Kunfman, Steven A., Geological Engineer, Kaiser-Cement Corporation	Stratigraphy, structure, origin, economic potential.
Dec. 1981	The Santa Clara Formation and Occurrences of Monte Bello Ridge, Northwest Santa Clara County, CA	William L. Vandenbushet San Jose State University MS Thesis	Stratigraphy and structure of Santa Clara Fm.
May 28 1982	Geology of the Permanente Property, KCC	Matheson, K.L., Associate Geologist, KCC	Geology of KCC's Permanente property, excluding quarry and plant areas.

APPENDIX B
SLOPE STABILITY STUDY

Slope Stability

Pit Area - Based upon a 1975 investigation of slope stability of the Permanente quarry by Golder, Brawner & Associates, recommended overall slope angles for the pit are listed below:

<u>Pit Area</u>	<u>Recommended Overall Slope Angle</u>	<u>Bench Angle (Min.)</u>
1. Slopes on south side Facing 00° (North)	Theoretically stable up to 75°.	62 degrees
Facing 020°	Theoretically stable up to 75°.	62 degrees
Facing 090°	Theoretically stable up to 57°.	----
2. Northern slopes from western end of pit-eastern end of serpentine slide area		
Facing 090°	60 Degrees	----
Facing 130°	46 Degrees	----
3. Northern slopes from eastern end of serpentine slide area to western end of pit		
Facing 130°	44 Degrees	

<u>Pit Area</u>	<u>Recommended Overall Slope Angle</u>	<u>Bench Angle (Min.)</u>
4. East face	Theoretically stable up to 72°	52 Degrees
Facing 130°		
Facing 200°	Theoretically stable up to 90°.	52 Degrees
5. Southern and southeastern faces excluding		
1. above		
Facing 230°	48 Degrees	-----
Facing 295°	46 Degrees	-----

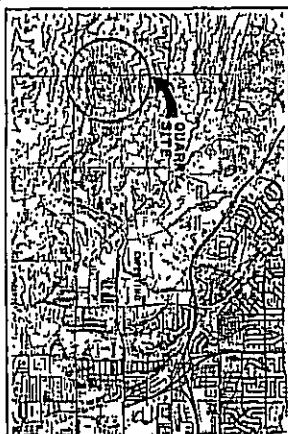
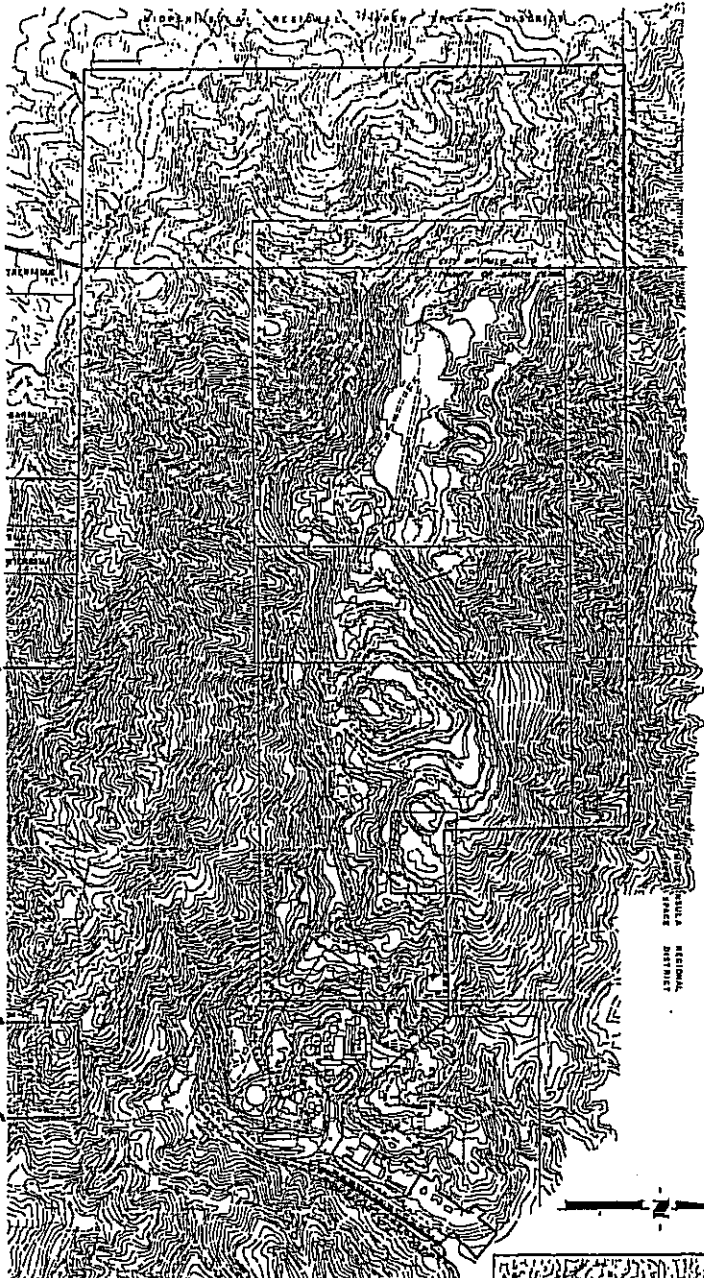
The existing and design overall pit slope angle of 45° (1:1) is within these recommendations.

The 1975 study was primarily concerned with the stability of the "serpentine slide area" located on the north-northwest side of the pit. No final recommendations were made concerning stabilization of this "serpentine" slide mass. However, in 1978 and 1979 approximately 440,000 cubic yards of material was removed from this area. The slope was graded and cut back to an overall angle of approximately 26°. Terraces, drainage

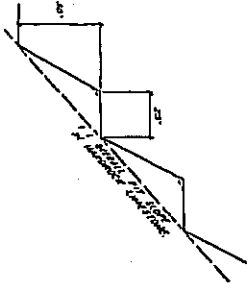
ditches, and revegetation were installed for drainage and erosion control. The regrading work to remove the driving force on the slide along with the fact that a block of limestone remains in the pit below the "serpentine slide area" acting as a buttress, has mitigated the previous problem of gross instability in this area. Since 1979, and probably due to recent wet winters, an area of localized surface slumping has occurred in the lower portion of the "serpentine" slope. This area does not reflect any gross instability in the slope and will be re-graded in order to restore drainage along terraces.

Groundwater seepage has not been observed in quarry faces except for isolated seepage zones on the "serpentine" slope. This seepage occurs seasonally, during wet weather in the winter and usually dries up in the summer. There are no uniform geologic structures in the serpentine unit and it appears that seepage follows random fractures and shear zones.

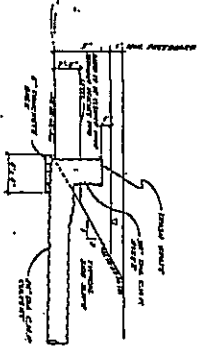
Rock Storage Areas - Rock fill slopes of 3 (horizontal) :1 (vertical) in the rock storage areas are shallow and should be stable. Existing rock fill slopes at slope angles 1-1/2:1 located just east of the main pit shown no sign of instability. Design fill slopes in the rock storage areas will be terraced and revegetated in order to control drainage and erosion.



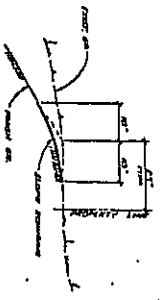
PIT WALL SECTION



BASIN AND OUTLET SECTION



TYPICAL SLOPE ROUNDING FOR TOP OF SLOPE



- NOTES**
1. PROPERTY MAPS SUPPLIED BY RAISER CEMENT CORPORATION.
 2. DETAILED ALL ELEVATIONS ARE BASED ON U.S.C.S. DATUM.
 3. FINISHING OPERATIONS FOR THE 70' AND 100' TRENCH SHALL BE AS SHOWN ON DRAWINGS BY RAISER CEMENT CORPORATION.
- ABBREVIATIONS**
- P.L. PROPERTY LINE
 C.C. CONCRETE CURB
 U.M. URBAN MAP
 J.M. JUNCTION

Received by
 DEPARTMENT OF CONSERVATION
 JUN 20 1964

Office of Mine Reclamation

INDEX

1	GENERAL NOTES
2	PERMANENTE QUARRY
3	PERMANENTE QUARRY
4	PERMANENTE QUARRY
5	PERMANENTE QUARRY
6	PERMANENTE QUARRY
7	PERMANENTE QUARRY
8	PERMANENTE QUARRY
9	PERMANENTE QUARRY
10	PERMANENTE QUARRY

91-43-0004

R-G Ruth and Goetz, Inc. architects engineering planning 215 THE ALAMO SAN JOSE CALIFORNIA 95128 TEL: 435-1111	RECLAMATION PLAN PERMANENTE QUARRY		REVISIONS <table border="1"> <thead> <tr> <th>NO.</th> <th>DATE</th> <th>BY</th> <th>DESCRIPTION</th> </tr> </thead> <tbody> <tr><td> </td><td> </td><td> </td><td> </td></tr> <tr><td> </td><td> </td><td> </td><td> </td></tr> <tr><td> </td><td> </td><td> </td><td> </td></tr> </tbody> </table>	NO.	DATE	BY	DESCRIPTION												
	NO.	DATE	BY	DESCRIPTION															
DESIGN: <i>W.C.</i> DRAWING: <i>W.C.</i> SCALE: 1"=200' SHEET NO. 1 OF 1	RAISER CEMENT CORPORATION SANTA CLARA COUNTY, CALIFORNIA	JUN 20 1964	RECEIVED BY: <i>[Signature]</i> DEPARTMENT OF CONSERVATION																

91-113-00004



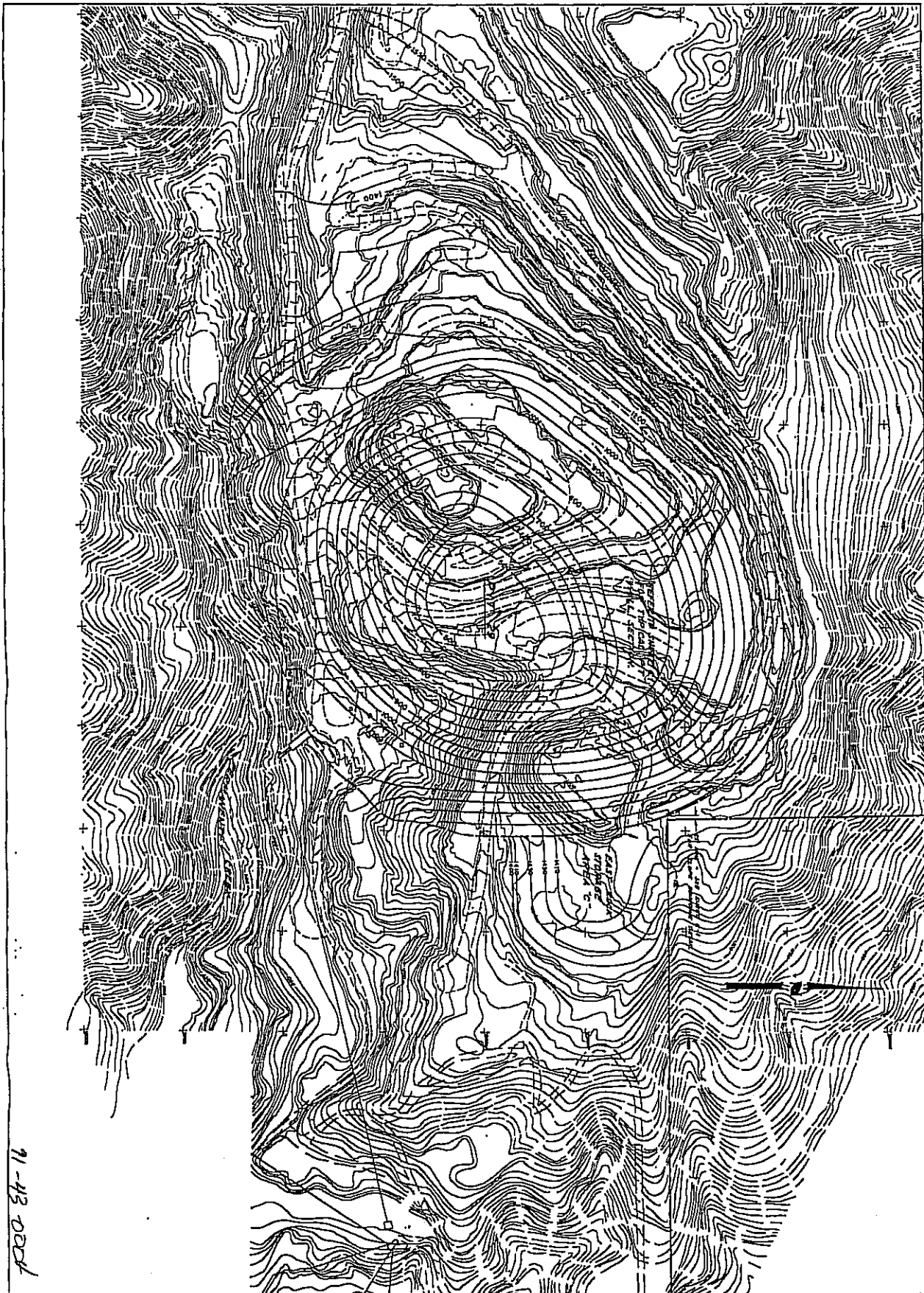
R+G Ruth and Goings, Inc.
 architects engineers planners
 1000 W. 10TH ST. SAN JOSE, CALIF. 95128
 TEL. (415) 281-1111 FAX (415) 281-1112

RECLAMATION PLAN
PERMANENT QUARRY

KAISER CEMENT CORPORATION SANTA CLARA COUNTY, CALIFORNIA

REVISIONS			
NO.	DATE	BY	DESCRIPTION

C2



71-43-000

R+G Ruth and Going, Inc.
 architecture engineering planning

112 THE BLANCKS SAN JOSE CALIFORNIA 95128 (408) 297-0075

DESIGN: D.A.L. DRAWN: J.H. CHECKED: J.H. DATE: 1/15/88

SCALE: 1"=100' PLS. NO. 1-1111

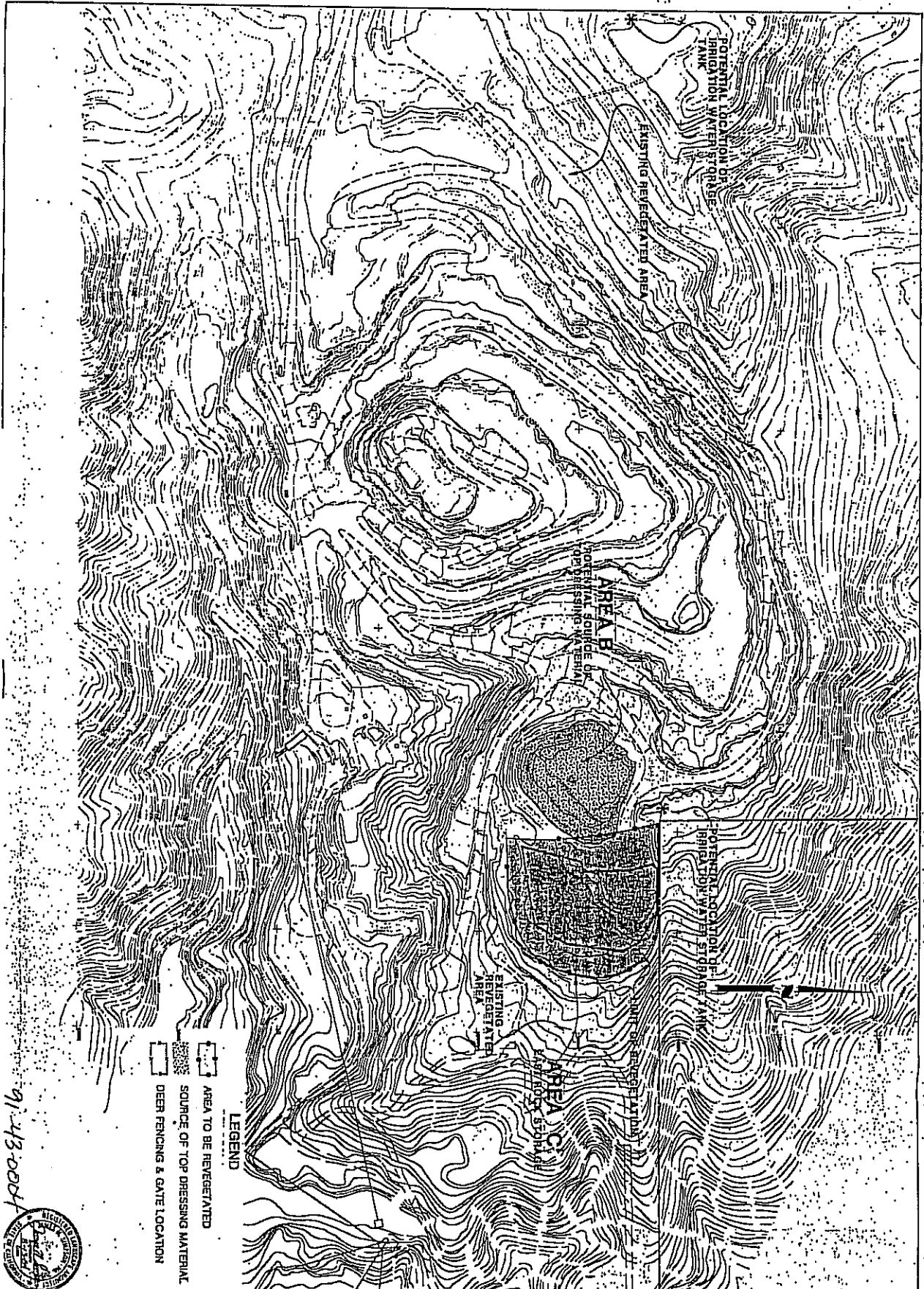
RECLAMATION PLAN

PERMANENTE QUARRY

KAISER CEMENT CORPORATION SANTA CLARA COUNTY, CALIFORNIA

REVISIONS			
NO.	DATE	BY	DESCRIPTION

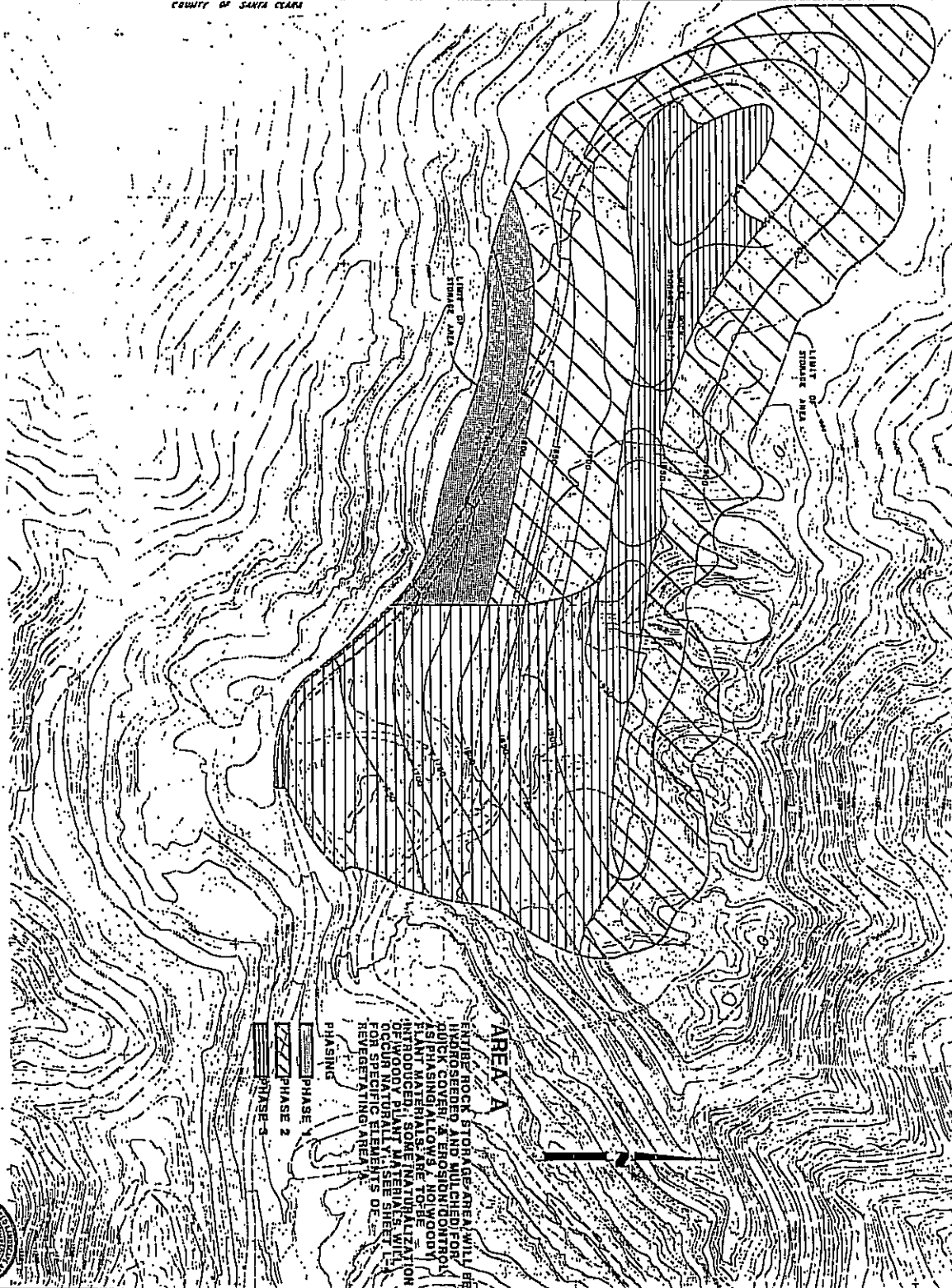
C3



91-413-0004

R+G Ruth and Going, Inc. Architecture engineering planning 810 THE ALPHEA San Jose, CALIFORNIA 95128 (408) 294-4212	REVEGETATION PLAN		REVISIONS	
	PERMANENTE QUARRY		DATE	DESCRIPTION
DESIGN: JACOB... CHECKED: ... SCALE: 1" = 100'	DRAWN: ... DATE: ... SHEET NO. 1 OF 1	MAIBER CEMENT CORPORATION SANTA CLARA COUNTY, CALIFORNIA	NAME DATE BY DESCRIPTION	REVISIONS

CITY OF PALO ALTO
COUNTY OF SANTA CLARA



AREA A
 ENTIRE ROCK STORAGE AREA WILL BE
 HYDRO SEEDED AND MULCHED FOR
 QUICK COVER & EROSION CONTROL
 AS PHASING ALLOWS. NOWOODY
 PLANT MATERIALS ARE TO BE
 INTRODUCED; SOME NATURALIZATION
 OF GOOD PLANT MATERIALS WILL
 OCCUR. THIS PLAN HAS BEEN PREPARED
 FOR SPECIFIC ELEMENTS OF
 REVEGETATING AREA.

PHASING
 PHASE 1
 PHASE 2
 PHASE 3

01-48-60



R-G Ruth and Going, Inc.
 architecture engineering planning

122

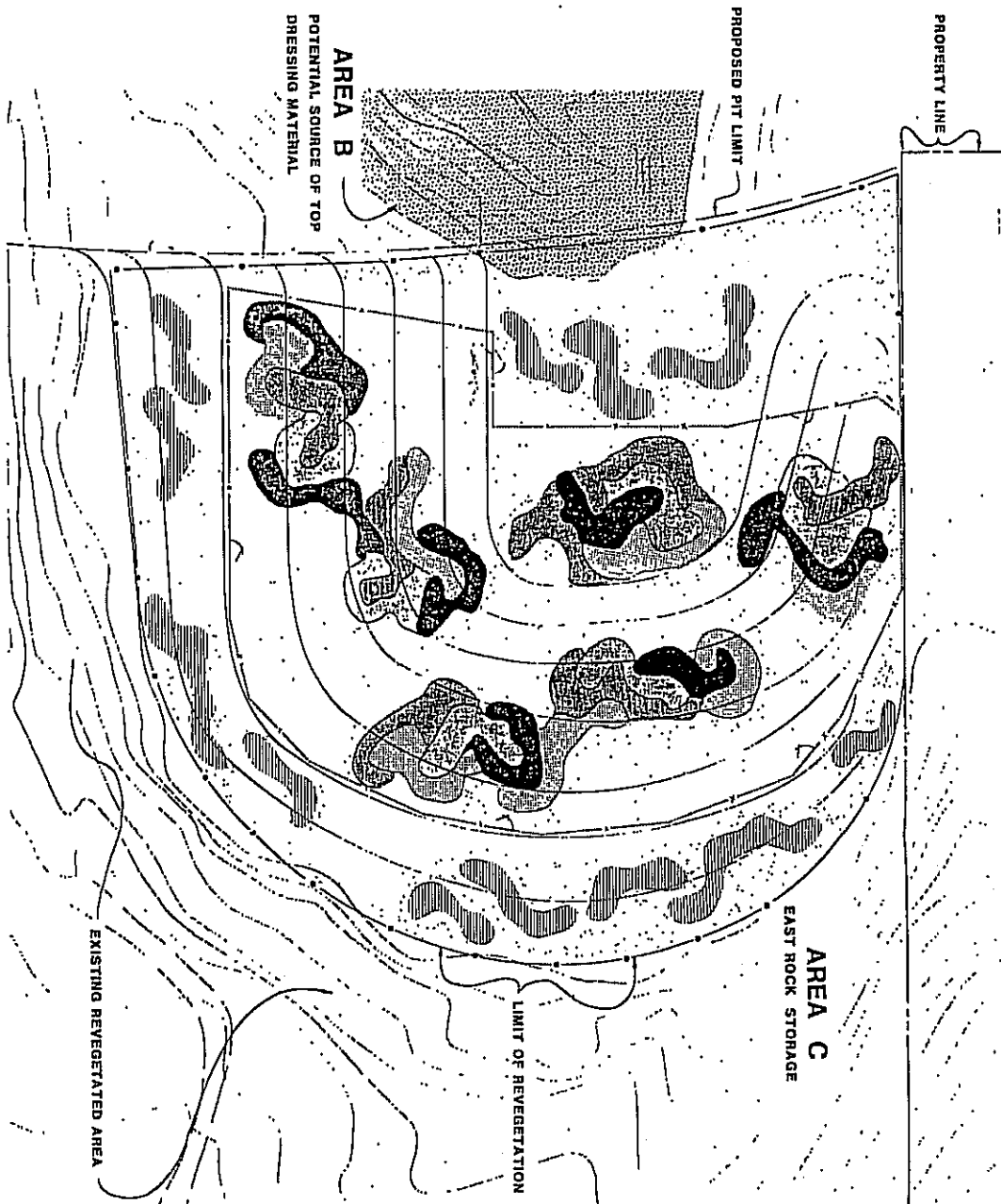
DESIGN: [blank] DATE: [blank]
 DRAWN: [blank] SCALE: 1"=100'
 PER. NO. 2222

REVEGETATION PLAN

PERMANENTE QUARRY

KAISER CEMENT CORPORATION SANTA CLARA COUNTY, CALIFORNIA

REVISIONS			
NO.	DATE	BY	DESCRIPTION



LEGEND

[Symbol]	AREA TO BE REVEGETATED	
[Symbol]	SOURCE OF TOP DRESSING MATERIAL	
[Symbol]	DEER FENCING	
PLANT LEGEND		
[Symbol]	COMMON BUCK BRUSH	210
[Symbol]	COYOTE BRUSH	180
[Symbol]	GOLD CUP OAK	210
[Symbol]	LEATHER OAK	210
[Symbol]	COYOTE BRUSH WILD BUCKWHEAT	400
[Symbol]	HYDROSEED MIX	
	TOTAL	1210

NOTE:

EACH PLANT GROUPING WITHIN FENCED AREA CONTAINS 40 SEEDLINGS.
 EACH PLANT GROUPING OUTSIDE FENCED AREA CONTAINS 25 SEEDLINGS FOUR HAYS 50.
 FIRST AREA TO BE REVEGETATED SHALL BE CONTOUR 1400 TO 1420. OTHER AREAS SHALL BE PLANTED AS FILL OPERATIONS ARE COMPLETED.



1" = 50' - 0"

91-45-00043



REVEGETATION PLAN		PERMANENTE QUARRY	
R+G Ruth and Going, Inc. architects engineers planners		KAISER CEMENT CORPORATION	
SANTA CLARA COUNTY, CALIFORNIA		REVISIONS	
DATE	BY	DATE	DESCRIPTION

